

 (704) 660-0334

Appropriate solutions for all your **compressed air needs**



OPERATOR MANUAL FOR **OABR I - 22 BOOSTER COMPRESSORS**

www.ozenairtech.com

 **ozen**
AIR TECHNOLOGY

EXCLUSIVELY COMPRESSED AIR SOLUTIONS

TABLE OF CONTENTS

1. CHAPTER / GENERAL INFORMATION	6	3. CHAPTER / MAINTENANCE	38
1.1 SAFETY SYMBOL AND GENERAL SAFETY MEASURES	6	3.1 PREVENTIVE MAINTENANCE INTERVALS	38
1.2 LIFTING AND CARRYING OF COMPRESSOR	10	3.1.1 GENERAL DESCRIPTION	38
		3.1.2 DAILY MAINTENANCE	39
		3.1.3 WEEKLY MAINTENANCE.....	39
		3.1.4 COMPRESSOR MAINTENANCE INTERVALS.....	40
2. CHAPTER / ABOUT COMPRESSOR	12	3.2 TORQUE VALUES	41
2.1 GENERAL	12	3.3 MAINTENANCE INSTRUCTIONS	41
2.2 COMPRESSOR UNIT	12	3.3.1 OIL LEVEL CHECK	42
2.3 TECHNICAL DATA	14	3.3.2 LEAK CHECK	42
2.4 PIPING & INSTRUMENTATION DIAGRAM	15	3.3.3 AUTO DRAIN VALVE CHECK	42
2.5 PRINCIPLES OF OPERATION	16	3.3.4 V-BELT TENSION CHECK	42
2.6 LUBRICATION SYSTEM	16	3.3.5 COMPONENTS CHECK	43
2.7 MAJOR COMPONENTS	16	3.3.6 SERPENTINES, INTERCOOLERS AND AFTERCOOLER, FLYWHEEL CLEANING	43
2.7.1 COMPRESSOR UNIT	16	3.3.7 CURRENT CHECK	43
2.7.2 SYSTEM	19	3.3.8 SAFETY VALVE CHECK	43
2.8 DESCRIPTION OF CONTROLS	20	3.3.9 SAFETY VALVE REPLACEMENT	44
2.8.1 MANUAL START	20	3.3.10 CHECK VALVE INSPECTION	44
2.8.2 AUTO START-STOP	20	3.3.10.1 CHECK VALVE REPLACEMENT	44
2.8.3 AUTO DRAIN	20	3.3.11 V-BELT REPLACEMENT	45
2.9 INSTALLATION	20	3.3.12 OIL CHANGE	45
2.9.1 INSPECTION	20		
2.9.2 LOCATION	20		
2.9.3 PIPING	21		
2.9.4 ELECTRICAL CONTROLS	21		
2.9.5 WIRING	21		
2.10 STORAGE	21		
2.11 OPERATION	21		
2.11.1 INITIAL START-UP PROCEDURE	22		
2.11.2 OIL RECOMMENDATION	22		
2.11.3 EXTREMELY COLD AMBIENT TEMPERATURES	23		
2.11.4 MOTOR LUBRICATION	23		
2.12 ADJUSTMENT	23		
2.13 OPERATOR PANEL	24		
2.13.1 MAESTRO 22 CONTROL PANEL DISPLAY	25		
2.13.2 MAESTRO 22 CODES AND DESCRIPTIONS OF ALARMS.....	28		
2.13.3 MAESTRO 22 MAINTENANCE CODES	31		
2.13.4 MAESTRO 22 DESCRIPTION OF STATUS IMAGES ON THE HOME SCREEN	32		
2.13.5 CONTROL PANEL USER SETTINGS	33		
2.13.6 CONTROL PANEL OPERATION SETTINGS	34		
		4. CHAPTER / TROUBLESHOOTING	46
		5. CHAPTER / WIRING DIAGRAM	50

THE DETAILS THAT DELIVER THE RIGHT RESULTS...

EXPERIENCE

Ozen Air Technology, with its industry experience of half-a-century and its large portfolio of compressed air products, provides reliable, efficient, and smart solutions

TRUST

Ozen's dedication to customer satisfaction has helped the company to build lasting relationships of trust and loyalty with its customers.

DURABLE AND EFFICIENT

All of the compressed air equipment in Ozen's portfolio have proven their durability under the toughest conditions. They provide high-quality, high-efficiency air.

QUALITY

Consistently manufacturing high-quality products is one of Ozen's fundamental tenets. To that end, Ozen continuously enhances its quality policies.





TECHNOLOGY

Ozen Air Technology is innovative. It always uses up-to-date technologies in compliance with world-standards.

R & D

With its creative team and competent infrastructure, Ozen is capable of developing its own technology through collaborations with several universities.

STRONG SERVICE NETWORK

Ozen Air Technology believes in maintainability. Its customers can enjoy uninterrupted manufacturing thanks to its accessible, fast and reliable service network.

COMPETITIVE

Ozen Air Technology acts in favor of its customers. Providing them with leverage is one of Ozen's strong suits.

RESPECT FOR THE ENVIRONMENT

Striving for a sustainable future, Ozen Air Technology selects for environmentally friendly practices and takes all necessary precautions while structuring its work processes.

GENERAL INFORMATION

CHAPTER 1

1.1 SAFETY SYMBOLS AND GENERAL SAFETY MEASURES

This manual must be read in its entirety and completely understood in order to operate the compressor safely and correctly. The safety instructions must be read carefully and all warnings must be to be strictly adhered to. Follow all local requirements, such as lock-out/tag-out procedures and the wearing of proper personal protection equipment, before attempting to service this equipment.



ROTATING PARTS

Make sure that your hands and body are kept safely away from the belt and pulley area before operating the compressor. Severe injuries or death may occur in cases when your hands or body are caught in the rotating parts.



ROTATING PARTS

Make sure that your hands and body are kept safely away from the fan area before operating the compressor. Severe injuries can occur if your hands or body are stuck in the rotating parts.



RESPIRATORY DISORDERS

Air discharged from the air compressor may contain oil and particulates. It is hazardous to directly inhale the air from the compressor.



COMPRESSED AIR

The air pressure exiting the compressor may be powerful. Ensure that the air outlet is tight and properly sealed before operating the compressor.



ELECTRIC SHOCK

Make sure that the power is disconnected and proper lock-out/tag-out is performed before connecting the compressor to the power supply or before servicing. Do not open the electrical cabinet cover before the power is turned off.



ELECTRIC POWER

Do not apply power until the installation is complete. Compressor must be properly grounded and adhere to local electrical codes.



FIRE

Perform proper oil level checks per the maintenance schedule. A low oil level may cause the machine to overheat. Although the oil has a high auto-ignition value, fire can occur in very extreme cases. Proper grounding is required on all electrical circuits.



HOT OIL PRESSURE

Before replacing the compressor oil, stop the compressor and make sure that the air is completely evacuated.



OIL LEVEL CHECK



HOT OIL AND COMPRESSED AIR

Before replacing the separator, make sure the system is switched off and the air in the system is completely evacuated. Otherwise, when the system is opened, there may be an explosion or skin burns when touched..



FLAMMABLE OIL

Exercise caution when working near or with oil. Do not expose oil to open flames and refrain from smoking near oil storage areas.

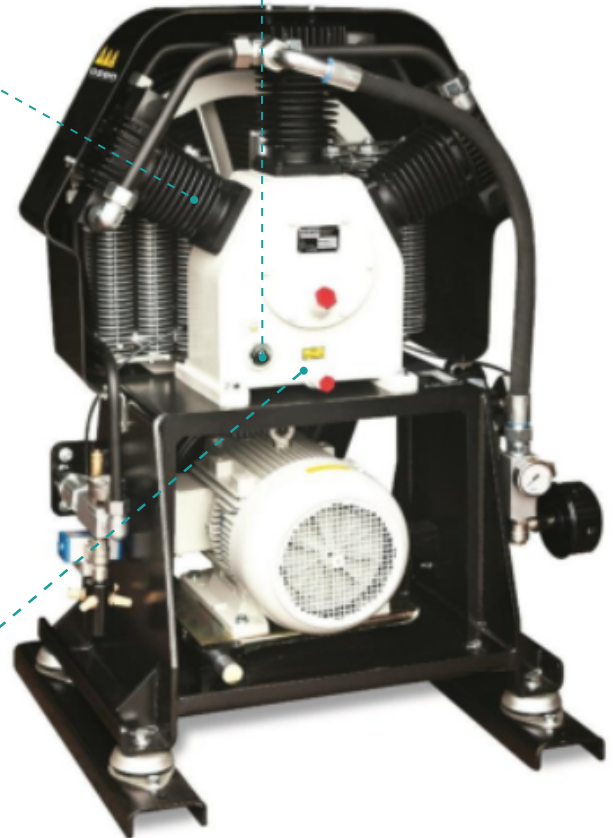

GENERAL INFORMATION

CHAPTER 1

GENERAL WARNING ICONS



IMPORTANT!

This symbol and the word "IMPORTANT!" contain important information about the use of the compressor. Read the information in these sections thoroughly for the compressor to be operated efficiently.



ATTENTION!

This symbol and the word "ATTENTION!" indicate the possible hazards that may be caused to the person and the environment. Failure to observe the warnings in this section may cause personal injury.



DANGER!

This symbol and the word "DANGER!" indicate the potential hazards that may be encountered. If ignored, it may result in serious personal injury or death.

GENERAL SAFETY ICONS

Read the general safety icons and descriptions carefully before using your compressor. Observe the safety notes in the sections in which you see these icons. Failure to observe safety icons may result in injury or death.



HOT OIL AND COMPRESSED AIR

Machine contains hot oil and compressed air. Exercise caution when performing any service work or repair. System pressure must always be completely relieved any time the system is opened. Failure to do so may result in equipment damage, person injury, or death.



FLAMMABLE OIL

Machine contains hot oil under pressure. Exercise caution whenever working with the oil system and never perform any service or repair while machine is under pressure or in operation.



ROTATING PARTS

Keep away from the rotating parts (fan, etc.) when the compressor is running. Contact with rotating parts may result in serious bodily harm or death.



ROTATING PARTS

Keep away from the rotating parts (belt and pulley system, etc.) when the compressor is running. Contact with rotating parts may result in serious bodily harm or death.



ELECTRIC SHOCK

Do not come into contact with live electrical components and/or cables. Doing so will result in electric shock, leading to severe injury or death. Always wear appropriate PPE (Personal Protective Equipment) per NFPA 70E and local regulations.



PINCH POINT

Keep hands away from the openings when removing or installing machine panels, especially when the machine is in operation. Suction from the machine may cause fingers or body parts to become pinched, causing injury.



HOT SURFACES

Do not touch the hot surfaces of the compressor when the compressor is operative or inoperative. Doing so may cause injuries.



RESPIRATORY DISORDERS

Do not breathe compressed air discharge. It is not meant for breathing air and can cause respiratory damage.



EARPLUG USE

Use earplugs while the compressor is running. Otherwise, you may experience hearing loss.



ELECTRIC POWER

Do not perform any work or repairs on live electrical circuits. Always remove electrical power, perform lock-out/tag-out procedures, wear proper PPE, and take safeguards to provide protection against electrical shock. Electrical shock will cause serious injury or death.

GENERAL INFORMATION

CHAPTER 1

1.2 LIFTING AND CARRYING OF THE COMPRESSOR



If you must lift the compressor, lift in full compliance with codes and regulations. Make sure entire lifting, rigging, and supporting structure has been inspected, is in good condition, and has a rated capacity of at least

the net weight of the compressor. If you are unsure of the weight, check before lifting. The distance between forklift's forks should be sufficient for lifting if the compressor will be carried and lifted with the forklift. Moreover, the forklift must have a rated capacity of at least the net weight of the compressor. The forklift's forks should be positioned under the compressor as shown in the figure below. The height of the compressor from the ground must be a maximum of 4 inches during transit.

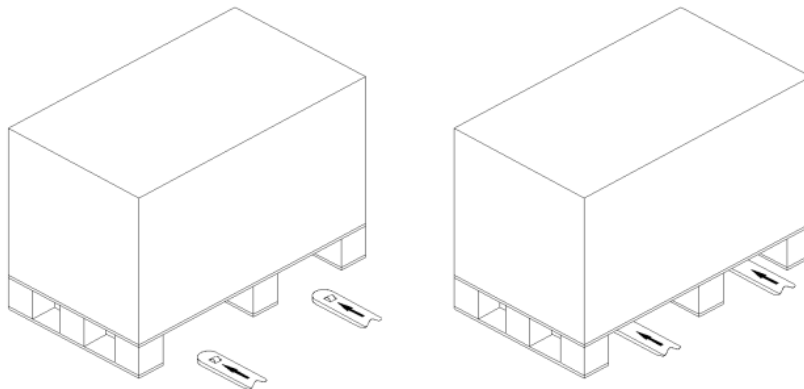

Figure 1 – Lifting and transporting by forklift

Do not distract the forklift operator during transit.

Verify the lifting hook has a safety clamp, and ensure a robust fastening with proper ropes or chain. Avoid swinging of the compressor while suspended by using guide ropes. Keep all persons clear from the compressor, especially underneath, when it is suspended. Lift the compressor no higher than necessary. Keep lift operator in constant attendance whenever the compressor is suspended.

Set the compressor down on level surfaces, capable of supporting its full weight.

NOTE: DO NOT RUN THE COMPRESSOR ON THE WOODEN PALLET THAT THE UNIT WAS MOUNTED ON FOR SHIPPING PURPOSES



ATTENTION!

If the weight of the truck to be used to transport the compressor transport is not selected according to the size of the compressor, then the forklift may incline forward and tip over due to excess weight. This will lead to substantial material damage and/or personal injury.

ABOUT COMPRESSOR

CHAPTER 2

2.1 GENERAL

OABR I - 22 booster compressors are one stage, three cylinder, reciprocating-type, air-cooled, splash-lubricated, compressed air booster compressors.

Working pressure of these compressors are 580 psi (40 bar). Do not attempt to modify the compressor to operate at higher pressures without the written approval of Ozen. Failure to do so may result in heavy damage to equipment, injury, or death.

These compressors are built with oversized serpentine intercoolers and aftercooler to allow for superior performance, longer life, and lower operating and discharge temperatures.

All stages include relief valves that allow the pressure to drop when the compressor stops. OABR I - 22 booster compressors increase the pressure by compressing the compressed air or gas supplied simultaneously to the cylinders with the help of a manifold. OABR I - 22 compressors are designed with a serpentine aftercooler after the discharge line for cooling the compressed air.

There is a safety valve at each stage to prevent an unwanted increase in pressure resulting from a problem with the valves or any other part. They must be periodically checked to ensure they are working properly and keep their proper set pressure values.

Medium pressure series compressors are equipped with stainless valves at each stage that are designed to maintain the airflow without any loss of pressure. They are easy to maintain and replace. The maintenance of valves is especially important as they are the main parts in proper and problem-free working of compressors. Lubricants not approved by Ozen can prevent valves from working properly due to the accumulation of carbon on springs and washers. Valves not working properly will cause an increase in working temperature and the deterioration of lubricant, which will further contribute to the break down of the valves.

NOTE: Working temperature range of the compressor is 32 - 122 °F (0 - 50 °C).

2.2 COMPRESSOR UNIT

Figure 2 shows the head group views of the OABR I - 22 booster compressor.

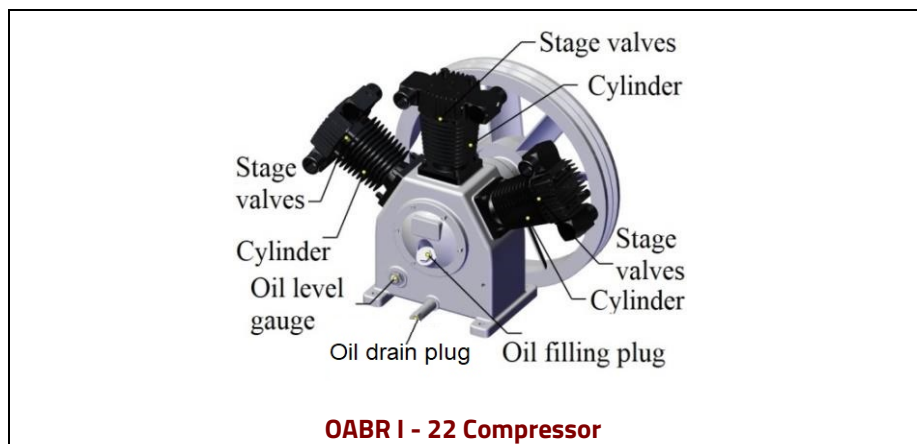

Figure 2 – OABR I - 22 compressor stages

OABR I - 22 booster compressor unit involves the main groups below:

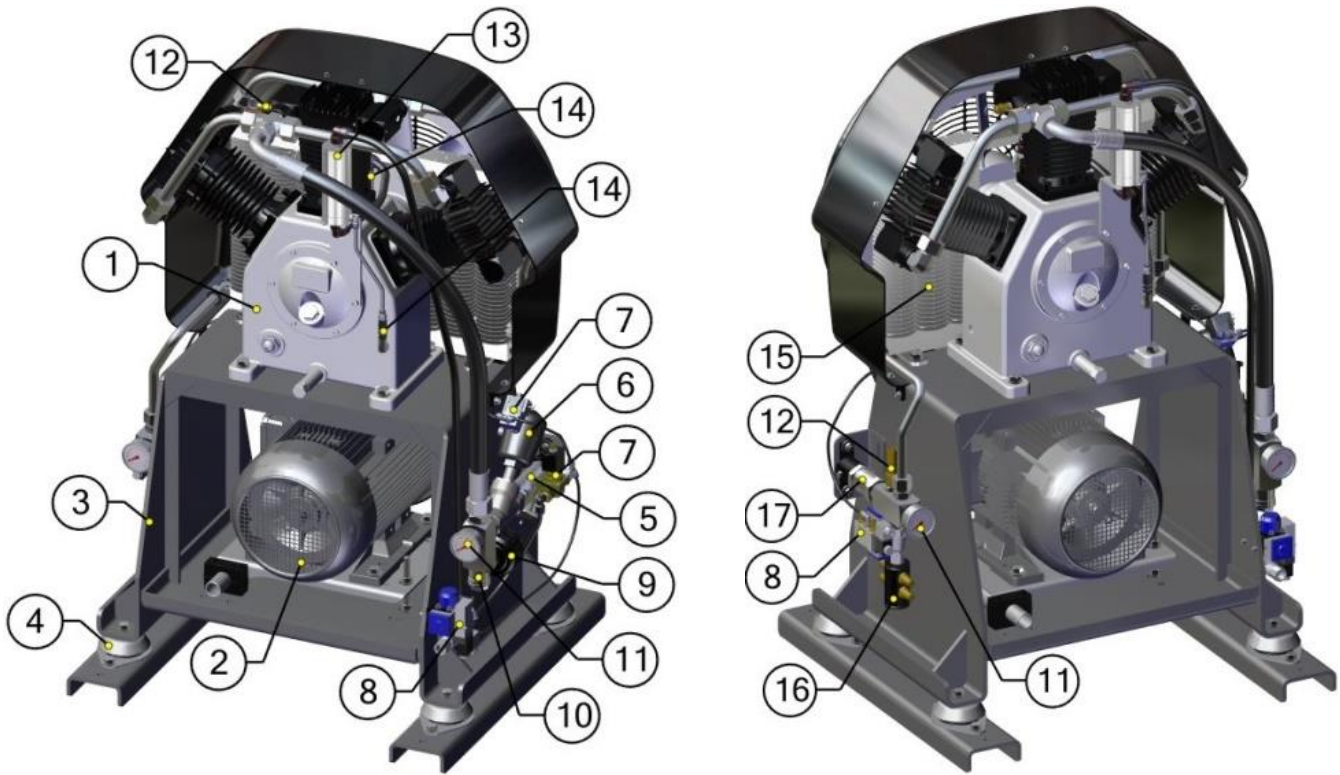

Figure 4 – OABR I - 22 booster compressor general layout

1. Compressor unit
2. Electric motor
3. Subbase
4. Shock mounts
5. Strainer
6. Pneumatic piston
7. Solenoid valve
8. Actuator
9. Vacuum filter
10. Check valve
11. Pressure gauge
12. Safety valve
13. Oil retainer (breather)
14. Check valve
15. Cooler
16. Filter
17. Check valve

ABOUT COMPRESSOR

CHAPTER 2

2.3 TECHNICAL DATA

COMPRESSOR	OABR I - 22
Sectors	Pet bottle blowing, Gas filling facilities, Industrial applications, laser cutting
Suction pressure, psi (bar)	116 psi (8 bar)
Working pressure, psi (bar)	580 psi (40 bar)
Free Air Delivery (FAD), cfm (l/min)	194 Cfm (6560)
Motor power, kW (Hp)	22 kW (30 Hp)
Speed, rpm	1300
Motor pulley diameter	Ø 190
Belt dimensions	22x2225
Compressor pulley diameter	Ø 600
Piston stroke, in (mm)	2.31 in (58.6 mm)
Number of stages	1
Number of cylinders	3
Cylinder diameter, in (mm)	2.36 in (60 mm)
Oil capacity, gal (liters)	1.06 gal (4 liters)
Working temperature, °F (°C)	32 - 122 °F (0 - 50 °C)
Weight, lbs (kg)	975 (439)
Dimensions, WxLxH, in (cm)	34.3 x 30.3 x 51.6 in (87x77x131 cm)

The OABR I - 22 booster compressors' design is based on the above data.

2.4 PIPING & INSTRUMENTATION DIAGRAM

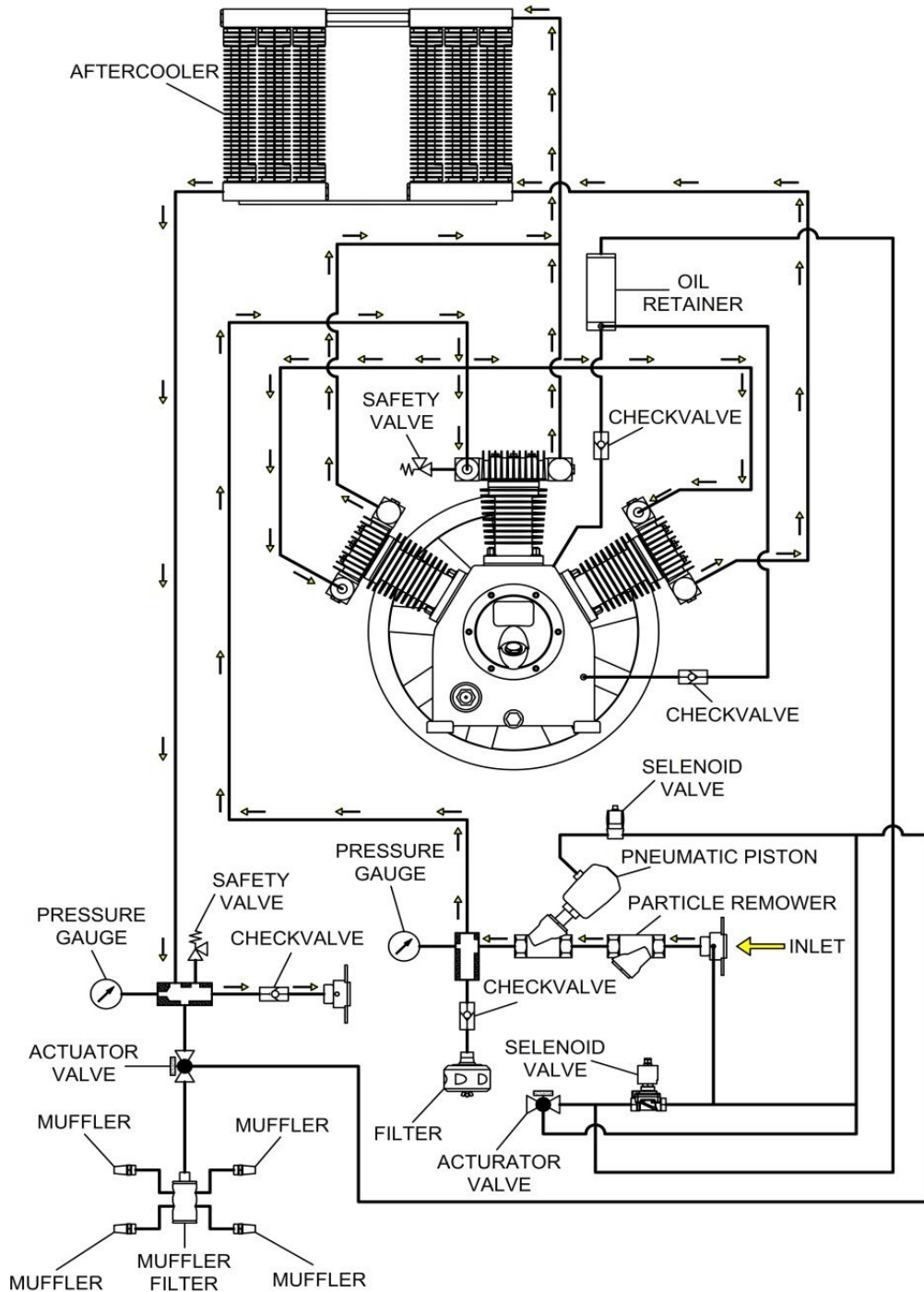

Figure 8 – OABR I - 22 booster compressor P&ID

ABOUT COMPRESSOR

CHAPTER 2

2.5 PRINCIPLES OF OPERATION

Refer to the P&ID (the Process & Instrumentation) diagram to familiarize yourself with the system layout.

There is a piston control valve at the inlet of the booster compressor. This valve remains open and allows air to pass through as the compressor runs. The primary air (gas) at 73-145 psi (5-10 bar) pressure accumulates in the inlet tank and comes to the piston pneumatic valve via the strainer. The pressure regulator on the inlet tank controls the inlet pressure. Air (gas) enters the system via the piston pneumatic valve. The air (gas) entering through this valve comes through the hydraulic hose to the intake manifold and from there to the pipe to allow it to enter the cylinders. There is a safety valve on the inlet manifold. The air (gas) increases from 73 to 580 psi (5 to 40 bar) in a single stage and leaves the cylinders through the aftercooler coils connected to the discharge manifold. The aftercooler is designed to dissipate the heat generated during the compression stages, reducing the temperature. The relief valve is a 3-way pneumatic valve controlled by a 3-way solenoid valve. The solenoid valve cuts in the control air to the discharge valves. The compressor starts and stops automatically with the control of the pressure switch.

The oil level can be monitored at the gauge provided at the right bottom side of the crankcase. An oil level switch is provided on the left side of the compressor to protect the compressor from low oil in its crankcase. When the oil level drops, the switch cuts off (opens its contacts,) thus opening the control circuit of the motor starter, which stops the electric motor. A signal lamp is provided to indicate that the motor has stopped as a result of low oil level.

2.6 LUBRICATION SYSTEM

The compressor unit is lubricated with the oil in its crankcase by splash lubrication. Splash lubrication means lubricating the system with the splashing effect created by the stick extending from one of the connecting rods. Replace the compressor's oil per the maintenance table.

2.7 MAJOR COMPONENTS

2.7.1 COMPRESSOR UNIT



Crankcase:

This is the frame that holds everything on it. It contains the oil that lubricates the system. The cylinders are mounted on it. The crankshaft is inserted into the bearing housings, which is an integral part of the crankcase. There is no maintenance or repair work that need to be done on this part. It needs to be cleaned inside when the oil is changed. If there is visible damage, it should be replaced.

(CONSULT WITH YOUR DISTRIBUTOR FOR REPLACEMENT OR MAINTENANCE)

**Crankshaft:**

It is overhung type, which means the bearings are on one side, and the crank pin (where connecting rods are mounted) are on the other side. This unique feature allows usage of single piece connecting rods which are far more accurate and safe than split con rods. Large bearings, in conjunction with low speeds, allow very long crankshaft life. Replace this part when life of bearings is over.

(CONSULT WITH YOUR DISTRIBUTOR FOR REPLACEMENT OR MAINTENANCE.)

Connecting Rods:

There are three connecting rods in the OABR I - 22 series booster compressors, two of which are the same and the third one is with a stick at the bottom part that provides the splash lubrication. Connecting rods move with the rotation of the crankshaft and the stick at the bottom of the connecting rod lubricates the system by creating a splashing movement in the oil. Connecting rods have high quality copper-bronze alloy bushings. When these bushings are abraded or worn, you should replace the connecting rods.

The OABR I - 22 series booster compressors have a friction reducing bearing on the connecting rods. These bearings provide maximum life of the connecting rods.

(CONSULT WITH YOUR DISTRIBUTOR FOR REPLACEMENT OR MAINTENANCE.)

Cylinders:

They are casted separately and are made of high grade casting materials, machined & honed to fine tolerances for long service life. The compression cylinders are mounted on guide cylinders to guide the crosshead piston assembly. Have the cylinders tested with proper testing equipment in general overhaul periods and replace them if they exceed the tolerance limits mentioned in parts list or if they exhibit a visible fault.

(CONSULT WITH YOUR DISTRIBUTOR FOR REPLACEMENT OR MAINTENANCE.)

Valve, Complete:

The complete valve consists of the internal valves and covers and is located on top of the cylinders. These complete valves should be maintained periodically and replaced if required. The valves must be replaced in every general overhaul period. Replacement of the valves can be made by Ozen Service Personnel or a properly trained customer.

(CONSULT WITH YOUR DISTRIBUTOR FOR REPLACEMENT OR MAINTENANCE.)

ABOUT COMPRESSOR

CHAPTER 2

Breather:

All piston-type machines have some compression leaks through the rings into the crankcase. There is a breather system to prevent pressure build-up in the crankcase. In the air compressor, the crankcase is connected to the inlet with a pipe coupling from where the breathing (venting) is made possible.

(CONSULT WITH YOUR DISTRIBUTOR FOR REPLACEMENT OR MAINTENANCE.)

Oil level switch:

The oil level switch is located in the crankcase. When the oil level drops, the float goes down and opens the control circuit that stops the motor. It gives a signal that the engine has stopped due to a decrease in the oil level.

(CONSULT WITH YOUR DISTRIBUTOR FOR REPLACEMENT OR MAINTENANCE.)

Pistons:

Pistons in compressor stages are connected to the crankshaft via connecting rods. Pistons move up & down and compress the air inside the cylinders with the motion supplied by crankshaft. Have the pistons tested with proper testing equipment in general overhaul periods and replace them if they exceed the tolerance limits mentioned in the parts list or exhibit a visible fault.

(CONSULT WITH YOUR DISTRIBUTOR FOR REPLACEMENT OR MAINTENANCE.)

Safety Valves:

Safety valves are found at the end of each stage of compressor unit. All the safety valves are subject to pressure tests and working pressure is set accordingly. Therefore, the safety valves prevent danger in case of rising pressure in the compressor. Safety valves are set and sealed by the manufacturer. Do not attempt to break the seal and change the settings of the safety valves. Otherwise, you may cause serious injuries or accidents may result in death. Check the safety valves in every general overhaul against leakages by using soapy water and replace if necessary. Return the old safety valves back to the manufacturer or dispose of properly.

(CONSULT WITH YOUR DISTRIBUTOR FOR REPLACEMENT OR MAINTENANCE.)

IMPORTANT: CONSULT WITH YOUR DISTRIBUTOR FOR REPLACEMENT OR MAINTENANCE.

2.7.2 SYSTEM

Subbase:

This is the part carrying the motor and compressor and is supported with four shock mounts.

Electrical Panel:

The OABR I - 22 booster's electrical panel is intended to be mounted on the wall separately from the compressor system. All electrical equipment that starts the motor and controls the system is located here.

Pressure Switch:

It is located at the front view / right section of the compressor. This switch both indicates the purifier pressure with the set pressures on its dial, while serving as a double circuit pressure switch. It controls the start-stop operation of the compressor. The pressure-sensing end of the pressure switch is connected to a port on the purifier. When the pressure inside the purifier reaches the set pressure, it cutoffs the control circuit, and stops the electric motor.

Auto Drain Valves:

The automatic drain incorporates a small piston with high pressure in the bottom, and low pressure on top. The surface where low pressure acts on is larger than the surface where the high pressure acts on the piston. Therefore, the force

acted upon the top is larger and causes the piston to sit on and seal the high-pressure vent port. The drain valves are controlled by a solenoid mounted on the pilot valve fitting. It receives compressed air from the 2nd stage air inlet and

sends it over the two drain valves, forcing them to close. When the solenoid is de-energized, it removes the control air over the top of the drain valve pistons, allowing the high pressure to act from the bottom of the pistons, opening the valve and performing the drain operation.



Motor: The compressor is driven by an TEFC electric motor.

Intercoolers and Aftercooler:

These are the cooling tubes that cool down the air getting warmed after compression in stages, which are located in interstages and at the discharge of the final stage of the compressor.

Check Valve:

It prevents the compressed air inside the purifier from backfeeding to the stages and protects the compressor from starting against back pressure.

ABOUT COMPRESSOR

CHAPTER 2

2.8 DESCRIPTION OF CONTROLS

2.8.1 MANUAL START

Compressor can be started or stopped by pressing the start / stop button on the control panel.

2.8.2 AUTO START-STOP



The OABR I - 22 series booster compressors are installed with a pressure switch. The compressor stops when pressure reaches the stop pressure set point on the pressure switch.

2.8.3 AUTO DRAIN

Automatic drain takes place with the help of a solenoid.

2.9 INSTALLATION

2.9.1 INSPECTION

The compressor should be inspected and checked for the following when received:

- a. Check if any damage occurred during shipping, handling, etc.
- b. Check the compressor nameplate to verify the equipment matches the working conditions.
- c. Check the electrical motor nameplate to verify compliance with the available power and electrical supply.
- d. Check the compressor to verify that it is filled with oil.

2.9.2 LOCATION

The location where the compressor is installed determines to a considerable extent the overall performance and service life of the unit. **Compressor should be located in an area that is dry and sheltered, well ventilated, not exposed to high ambient temperatures, airborne contaminants such as dust, fumes, lint, vapor, steam, gases, engine exhaust and other contaminant.** The floor must be flat and capable of supporting the load of the system weight. Install the compressor at least 24 in (60 cm) from surrounding walls to ensure adequate cooling and access for service.

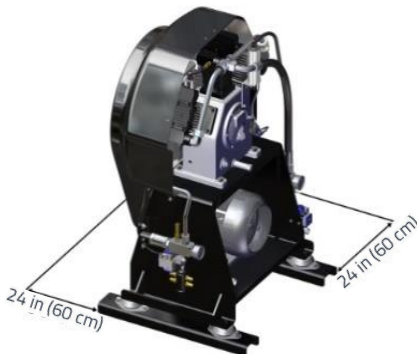

Figure 9 – OABR I - 22 series compressor layout

2.9.3 PIPING

If piping is required between the compressor and the filling panel or fill station, depending on the length between the compressor and the filling panel, properly selected stainless steel pipes must be used. The piping should be installed in full compliance with all federal, state and local codes, standards, and regulations. If required, consult distributor for further information.

2.9.4 ELECTRICAL CONTROLS

IMPORTANT:

Although all electrical instructions are addressed directly to the reader, the actual inspection, wiring, installation, maintenance, repair, etc. must be carried out by licensed and certified electricians only.

Make electrical connections to the compressor in accordance with the wiring diagrams and in full compliance with all applicable federal, state, and local standards, codes and regulations, including those dealing with earth grounding requirements. A few electrical checks should be made to ensure that the first start-up will be trouble free. Make the following checks before attempting any start up:

- a. Check line voltage. Verify that the compressor motor corresponds with these specifications.
- b. Check the electrical motor nameplate to verify the compliance with the available power and electrical supply.
- c. Check tightness of all electrical connections, including those in the electrical panel of the compressor.
- d. At start up, check the direction of rotation to ensure that the flywheel rotates in the direction of the arrow. Although a few minutes of operation in the wrong direction of rotation will not seriously damage the compressor, it will cause serious damage to the compressor if it runs in this position for a long time. The cooling air flow will be reversed and the compressor cylinders cannot be cooled down. Additionally, the splash lubrication system will not operate correctly, depriving the compressor of lubrication.

Check starter and maximum load for conformity with the motor power and current data.

2.9.5 WIRING

It is important to select the right size and capacity wire and fuses. Install a switch on the wall with magnetic protection and a capacity larger than the motor's full load current. Consult a Licensed Electrician for proper sizing per local code.

2.10 STORAGE

NOTE: If the compressor will not be working, but stored for a long time, it is required to operate the compressor at least twice a month for 1 hour to lubricate inner parts. Failure to do so will cause oxidization on the inner parts and cause trouble for the operator and compressor during the next start up.

NOTE: If the compressor has been stored with the old oil inside, first run the compressor for a while and stop it after the oil is warmed up, drain the old oil, and refill with new oil.

ABOUT COMPRESSOR

CHAPTER 2

2.11 OPERATION

2.11.1 INITIAL START-UP PROCEDURE

Follow these procedures when making the initial start-up of the compressor:

- a. Make sure that you have read this manual carefully, fully understanding it. If you have any questions, contact Ozen Air Technology or its Partner.
- b. Make sure that all the preparations described in the installation section of this manual have been made.
- c. Check the oil level in the crankcase.
- d. Check the pressure switch and make sure that the pressure adjustments are set at the proper start / stop pressures.
- e. Rotate the compressor flywheel several times by hand to verify that it is free and working properly.
- f. Keep all objects such as tools, rugs, etc. away from the compressor.
- g. Check the direction of rotation. Rotation must be in the direction of the arrow marked on the crankcase and/or flywheel.
- h. Press the start button to start the compressor. Check and verify that there is no abnormal vibration or any abnormal sounds.
- i. Let the compressor run without producing pressure while the purifier drain valve is open for 10 minutes to observe if any abnormalities in the operation of the compressor exist. This will allow for the lubrication of all parts.
- j. Check for possible leaks in the piping. If there are any leaks, stop the compressor and let it cool down before repairing the leaks.
- k. Check the last stage safety valve for proper operation. The safety valve must open and release pressure at the set point stated on it. If the safety valve does not open, stop the compressor without waiting for the pressure to rise.

2.11.2 OIL RECOMMENDATION

The oil level should be checked before each start up. **Top up to half way in the sight glass. 1.06 gal of oil is required for the OABR I - 22 series booster compressor. This amount should be loaded during each replacement.**

RECOMMENDED OILS

Oil	Type	Quantity
Ozen ZenLube 100 Oil	Synthetic	1.06 gal (4 liters)

Ozen ZenLube 100 Compressor Oil

The use of Ozen ZenLube 100 oil can result in cleaner compressors and lowered deposits compared to conventional mineral oils, resulting in longer running periods between maintenance intervals. Its excellent oxidation and thermal stability safely allow extended life capability while controlling sludge and deposit formation. It possesses outstanding anti-wear and corrosion protection, which enhances equipment life and performance.

SPECIFICATIONS	TEST METHOD	OZEN ZENLUBE 100
Viscosity, cSt		
@ 40 oC	ASTM D 445	96
@ 100 oC	ASTM D 445	11.5
Flash point, oC	ASTM D 92	244C (472F)
ISO Viscosity Index	ASTM D 2270	100

- Do not use another type of oil without prior written approval of Ozen Air Technology. Do not mix different brands and types of oils.
- If you desire to change the oil you use with another approved brand of oil, refill with the new oil after you make sure that you completely drain the old oil from the crankcase. It is also recommended to wipe the crankcase clean.

2.11.3 EXTREMELY COLD AMBIENT TEMPERATURES

Operating conditions different than stated conditions must be reported to the compressor manufacturer to make the necessary changes to adapt the compressor to the current conditions, if possible. For instance, if the compressor needs to work in an extremely cold ambient temperature below freezing temperatures, a crankcase heater can be attached to the crankcase of the compressor to prevent the negative effect of the cold ambient temperatures.

2.11.4 MOTOR LUBRICATION

Electric motors on Ozen OABR I - 22 series booster compressors are supplied with greased and sealed bearings. They do not need further maintenance.

2.12 ADJUSTMENT

Pressure switch adjustment (for auto drain models)



When adjusting the pressure switch, verify compressor is operating and make adjustments according to the final outlet pressure.

- Adjustment is done by rotating the Red Adjustment Screw.
- You can adjust PH1 pressure switch to the required upper pressure (working pressure) by turning the screw on the pressure switch clockwise or counter-clockwise. Turn the screw clockwise to increase the upper pressure, counter-clockwise to lower.
- Standard Pressure Switches used on OABR I - 22 have a standard differential of 10 % of working pressure. For example, a pressure switch set at 40 bar will work between 36 and 40 bar.

Note: Even though there is a monitor scale in the front of Pressure Switch, setting a value from there is very difficult. It is best to use system pressure gauges.

Safety Valves

CAUTION:

- Do not adjust the safety valves and do not alter their original settings. Only authorized service technicians are certified to make such adjustment. If required, replace and return the old one for reconditioning to the manufacturer or to a dealer nearest you.
- Do not remove leaking safety valves and do not replace them with a plug. This may be extremely dangerous. If a safety valve leaking, replace it.

ABOUT COMPRESSOR

CHAPTER 2

2.13 OPERATOR PANEL

The compressors included in this manual use the Maestro 22 control panel.

Below you will find general information about Maestro 22.

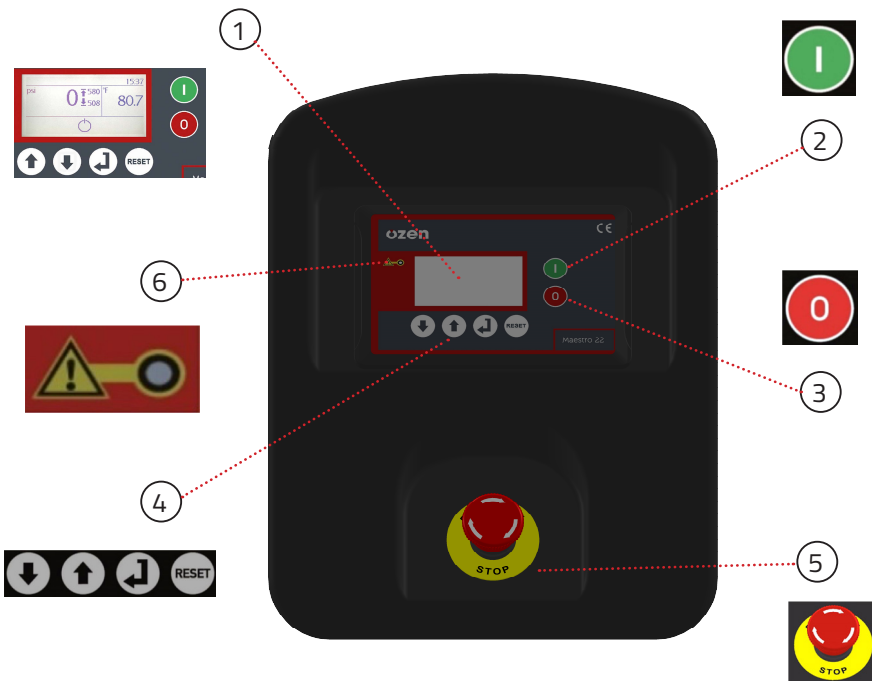

1 Digital Display: There are symbols such as pressure in the air tank, temperature value at screw oil outlet, error code in case of any faults, symbols such as the fan symbol while fan is running, texts and symbols.

2 Start button. It is the button used to start the compressor.

3 Stop button. It is the button used to stop the compressor.

4 Menu Keys: These keys are used for navigating through the controller menus. They are used when making any setting/parameter changes.

5 Emergency Stop: It is used to immediately stop the compressor in the case of any type of emergency. Do not use this button for normal stopping of the compressor.

6 Compressor malfunction LED. This LED is red in color.

The control panels employed in the compressors differ according to the operation of the compressor and the power rating of the compressor.

Maestro 22

An overview of the appearance of the Maestro 22 control panel exterior is given in Section 2.13

The Maestro 22 control panel is exclusively produced for Ozen Air Technology and is designed for easy control of the compressor. The Maestro 22, which is generally mentioned in Section 2.13 OPERATOR PANEL, will be described in detail in this section.

The Maestro 22 control panel:

- Controls the compressor.
- Shows the ideal service intervals for the compressor.
- Protects the compressor.



The Maestro 22 controller, along with the the sensors, overloads, etc., within the compressor, provides protections for the compressor. It will stop the compressor if an unsafe condition is sensed and will notify the user of the problem by displaying an error code. Never defeat any safety measures provided with this compressor and/or controller. Alarms will stop the compressor, warnings will not. Always investigate the cause of alarms before attempting to re-start the compressor. Always obey warnings and take measures to clear them as soon as possible.

Please notify your local Ozen Distributor to schedule service when you see a maintenance warning on your Maestro 22 controller.

2.13.1 MAESTRO 22 CONTROL PANEL DISPLAY

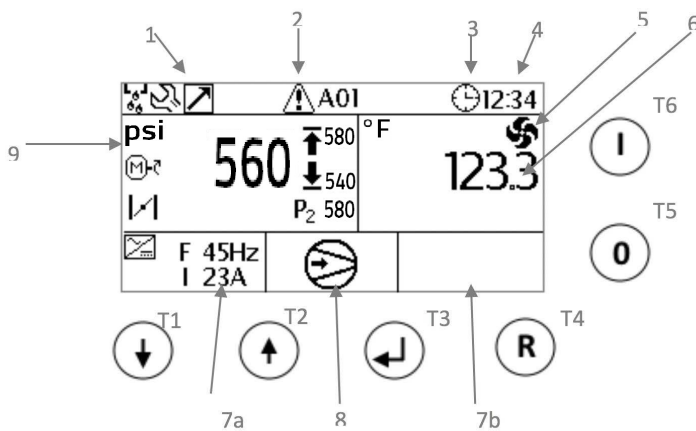

MEANING OF ICONS

1. General icons:
 - I01, Condensate Drain
 - I02, Multi Unit Operation
 - I03, Master / Slave Operation
 - I04, Maintenance Messages
2. Alert or Maintenance Messages
3. Start / Stop by Timer Activation
4. Time (hour : minute)
5. Cooling Fan is Running
6. Compressor Temperature
7. Inverter Section: Data will populate once inverter becomes active. Dependent upon air temperature and operating pressure, data is shown on left side (7a) or right side (7b).
8. Shows compressor status. From I07 up to I13 they correspond to:
 - Compressor Off
 - Waiting for Security Timer
 - Pressure Set
 - Remote Start / Stop Control Active
 - Compressor On
 - Start / Stop is Waiting by Timer (In this case, screen shows day and time.)
 - Internal Pressure (P2 Parameter) is lower than AP4
9. Pressure Section:
 - Operating Pressure and Start / Stop Pressures
 - Auxiliary Pressure Converter (Activation Required)
 - Icon I17, Motor Operating
 - Icon I18, Solenoid Valve is Open

In case of alert, alert message appears on the bottom of the screen (7a, 7b, and 8).







Control of compressor is provided with 6 button as below (refer to screenshot above):







- T1, Decrease, Scroll Downward
- T2, Increase, Scroll Upward
- T3, Change or Confirm
- T4, Reset or Back
- T5, Stop Compressor
- T6, Start Compressor







ABOUT COMPRESSOR





CHAPTER 2

Images: Icons on Top of the Screen

I01		Condensate Drain Active
I02		Multi-Unit Operation Active
I03		Master/Slave Operation Active
I04		Maintenance Time
I05		Alarm
I06		Weekly Start / Stop Timer Active

I07		Compressor Off
I08		Waiting for Security Timer
I09		Pressure Setting, Discharge during operating or stand-by
I10		Remote Start / Stop Control Active
I11		Compressor On
I12		Stopped with Timer (Screen shows the next operation time)

I13		Internal Pressure P2 Too High
Images : Left Side=Pressure / Right Side=Temperature		
I14		Fan Operating
I15		PID and Ports 4/20mA Active
I16		Stop Pressure
I17		Start Pressure
I18		Motor Operating
I19		Compressor Operating in Loaded Condition

Menu Setting: Date, Time, Contrast, Measure Units		
I20		Measure Units Active
I21		Contrast
I22		Language
I23		Date and Time

ABOUT COMPRESSOR

CHAPTER 2

2.13.2 MAESTRO 22 CODES AND DESCRIPTIONS OF ALARMS

The table of the error codes found on the left side of the Maestro 22 control panel is shown below. In the case of some of these errors, the compressor will not operate until the error is resolved. The following table describes which errors will shut down the compressor immediately and which will allow the compressor to run for 30 seconds before shut down. Please contact your local Ozen Distributor when you detect such errors.

Alarms that directly shut down the compressor

CODE	DESCRIPTION	CAUSE	ACTION
01	EMERGENCY STOP	Emergency stop button open (IN1)	Release emergency stop button
02	MOTOR OVERLOAD	Main motor thermal overload open (IN2.)	Motor thermal overload relay (1E4) malfunction. Contact your local Ozen Distributor.
09	DRIVE FAULT	Input relay fault drive open/closed (alarm managed with input enabled, only (C21=1/2).)	Contact your local Ozen Distributor.
11	HIGH PRESSURE	Working pressure over set point of WP2.	Contact your local Ozen Distributor.
13	HIGH TEMP.	Air end temperature over set WT1	Contact your local Ozen Distributor.

14	LOW TEMP.	Air end temperature lower than set point of WT5.	Increase the ambient temperature over 14 °F. If problem persists, contact your local Ozen Distributor.
18	POWER OFF	In case of power loss and compressor set to manual restart.	Check the power connection of compressor and restart compressor.
20	TEMP. MOTORE	PTC input open	Motor over temperature. Contact your local Ozen
22	INPUT IN7	Parameter C12 = 3 (generic alarm)	Distributor Check the phase connection. If problem persists, contact your local Ozen Distributor.

Alarms that shut down the compressor after 30 seconds

26	PRESS. TRANSD. FAILURE	Working pressure transducer failure.	Contact your local Ozen Distributor.
27	AUX. TRANSD. FAILURE	Aux. pressure transducer failure.	Contact your local Ozen Distributor.
28	LOW VOLTAGE	Power supply to the controller lower than 9.5VAC and auto reset performed when the power goes over 10.6VAC. It is not visualized if it has been disabled in menu 4 of COMPRESSOR SETUP.	Contact your local Ozen Distributor.
29	SAFETY	Timer S—elapsed. This alarm is detected if the parameter, SAFETY, is set to YES.	Contact your local Ozen Distributor.
30	HIGH TEMP. WARNING	Air end temperature over set point of WT2.	Contact your local Ozen Distributor.
33	RS 485 FAILURE	Compressor start/stop is initiated via RS232 and the watchdog function is enabled (see MODBUS protocol communication.)	Contact your local Ozen Distributor.
60	INVERTER FAILURE	Shut down alarm detected from inverter via RS485 (managed by inverter connected via RS485 only (DRO>0).)	Contact your local Ozen Distributor.
62	COMMUNICATION INVERTER	No communication to inverter via RS485 (managed by inverter via RS485 only (DRO>0).)	Contact your local Ozen Distributor.

NOTE:

Every time a shut-down alarm is detected, LED DL1 is activated and the alarm message is stored into the alarm list. Once the cause of the alarm has been eliminated, push the button R to reset the message and start the compressor.

ABOUT COMPRESSOR

CHAPTER 2

WARNINGS

CODE	DESCRIPTION	CAUSE	ACTION
30	HIGH TEMPERATURE WARNING	Air end temperature over set point of WT2.	Contact your local Ozen Distributor.
35	DATA LOST	Default data is lost or corrupt.	Contact your local Ozen Distributor.
37	MULTIUNIT FAILURE	No communication or master failure. Each slave works on its own.	Contact your local Ozen Distributor.
39	LOW VOLTAGE	Power supply to the controller is lower than 11.6VAC, automatic reset when the voltage rises over 12VAC.	Contact your local Ozen Distributor.
40	HIGH VOLTAGE	Power supply to the controller is over 14.5VAC.	Contact your local Ozen Distributor.
41	CLOCK FAILURE	Cycle the power to the compressor.	Check control panel. If problem persists, contact your local Ozen Distributor.
42	RS485 FAILURE	Master/slave communication is lost, auto reset when communication is restored.	Contact your local Ozen Distributor.
43	ORA LEGALE/SOLARE	Automatic change DLS / Summertime.	Update time in daylight saving time setting.
61	ALLARME INVERTER	Inverter failure detected in case of inverter connected via RS485 (managed in case of inverter communication via RS485 enabled (DR0>0))	Contact your local Ozen Distributor.

2.13.3 MAESTRO 22 MAINTENANCE CODES

It is possible to reset the maintenance error codes while the compressor is running. You can reset the error code that appears on the display by pressing the ENTER key on the Maestro 22 control panel.

When you see maintenance error codes on the Maestro 22 screen, please contact your local Ozen Distributor. Adherence to the recommended compressor maintenance schedule in the Operator Manual is very important for the service life of the compressor and it should be completed without exceeding the maintenance time. Failure to perform the required maintenance will void any warranty and/or extended warranty.

CODE	DESCRIPTION	ACTION
S-A	Service Plan A	See COMPRESSOR MAINTENANCE PERIODS section in the 3.1.4 COMPRESSOR MAINTENANCE INTERVALS.
S-B	Service Plan B	See COMPRESSOR MAINTENANCE PERIODS section in the 3.1.4 COMPRESSOR MAINTENANCE INTERVALS.
S-C	Service Plan C	See COMPRESSOR MAINTENANCE PERIODS section in the 3.1.4 COMPRESSOR MAINTENANCE INTERVALS.
S-D	Service Plan D	NOT APPLICABLE TO THIS MODEL

ABOUT COMPRESSOR

CHAPTER 2

2.13.4 MAESTRO 22 DESCRIPTION OF STATUS IMAGES ON THE HOME SCREEN

POWER ON

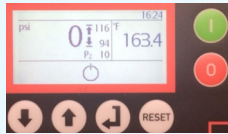

The image on the left becomes active on the Maestro 22 HOME screen when the power is ON.

START THE COMPRESSOR



To start the compressor: You must press the Maestro 22 START button.

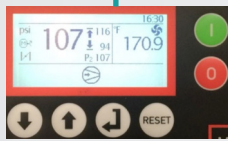

From this point, the HOME screen of the Maestro 22 will switch to the display on the left. The pressure value is for visual purposes only. Actual display value will be the compressor's discharge pressure.



ATTENTION!

Do not operate the compressor without the machine guards installed.

STOP THE COMPRESSOR

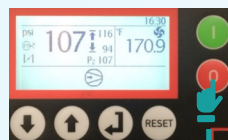

To Stop Compressor: When you press the stop button, the compressor will shut down. If the compressor is loaded at the time the stop button is pressed, it will unload. There are unload and safety timers involved, so the time that the compressor runs after pressing the stop button will vary, based upon the times set points of these timers (which are password protected.) By default, the compressor will run unloaded for between 10 and 130 seconds, dependent upon the timers being satisfied and their set points. If the compressor is unloaded when the stop button is pressed, the compressor will continue to run unloaded until the timers are satisfied.

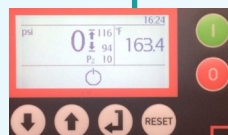

2.13.5 CONTROL PANEL USER SETTINGS

The Maestro 22 control panel is configured according to user requirements before the compressor leaves the Ozen factory.

The settings portion of the Maestro 22 control panel is password-protected, which are only known to Ozen Technical Staff and Service Personnel. Entry of incorrect settings can present dangers to both personnel and equipment by disabling safety devices and allowing higher than rated pressures. This is why passwords are not provided to the user.

The Maestro 22 control panel is programmed in the Ozen factory according to the technical information required by the user. The user cannot enter and make changes to all settings in the programmed Maestro 22 control panel. The settings that the user can see and change are limited.

USER HOME SCREEN OF MAESTRO 22

When the compressor gives an alarm, you will see the alarm code on the screen. Reference the Codes and Descriptions of Alarms section of the Operator Manual for more information on the alarm, as well as some helpful guidance on troubleshooting.

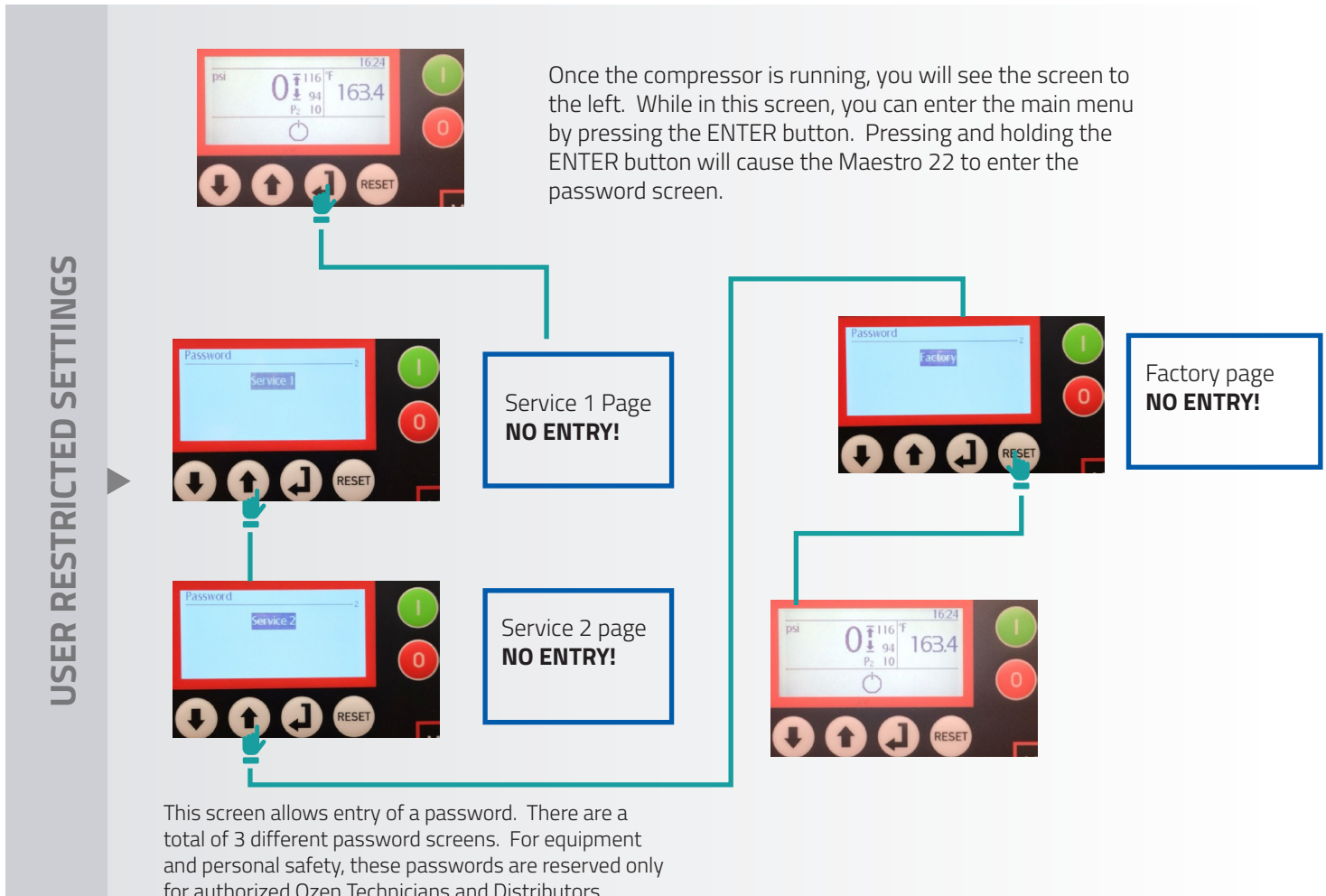

ABOUT COMPRESSOR

CHAPTER 2

2.13.6 CONTROL PANEL OPERATION SETTINGS

HOME SCREEN

The main menu of Maestro 22 control panel is explained below:

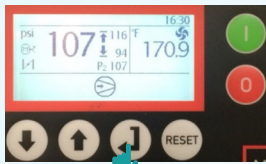

You can navigate through the menu via the ENTER button. After entering the main menu by pressing the ENTER button, the screen changes to what is shown to the left. In order to reach other lines in the menu, use the DOWN button.

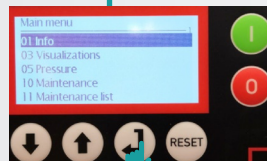

01-Information Menu: General information of the compressor will be shown in this menu.

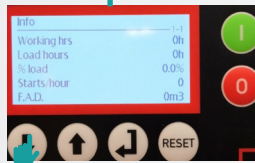

01-Information Menu

- Working hours (total run time)
- Loaded hours
- Percentage of time loaded
- Number of start per hour
- Flow rate
- Serial number
- Software

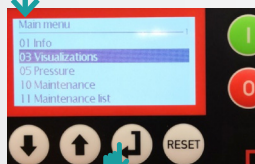
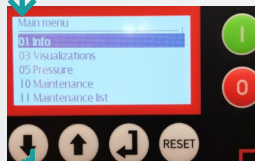

03- Screen Settings Menu: Maestro screen setting can be changed in this menu.

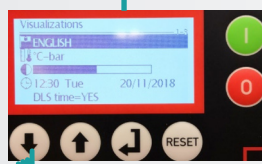

- 03-Screen Settings Menu
- Language of Control Panel
 - Pressure and Temperature Units
 - Screen Brightness
 - Time and Date
 - Daylight Saving Time

PRESSURE SETTINGS

PRESSURE SETTINGS

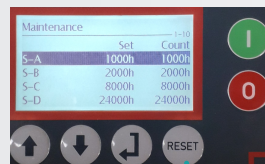
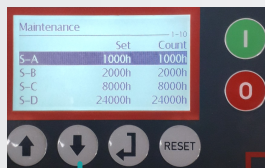
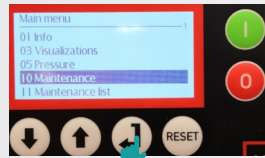
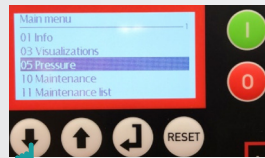
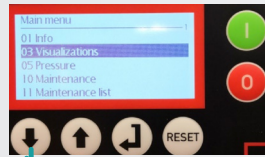

05- Pressure Menu: When you enter this menu, nothing is shown. You cannot change the pressure value.

10- Maintenance Menu: Maintenance timers can be found in this menu.

10-Maintenance Menu

- S-A> See chapter "2.13.3 MAESTRO 22 MAINTENANCE CODES"
- S-B> See chapter "2.13.3 MAESTRO 22 MAINTENANCE CODES"
- S-C> See chapter "2.13.3 MAESTRO 22 MAINTENANCE CODES"
- S-D> See chapter "2.13.3 MAESTRO 22 MAINTENANCE CODES"

ABOUT COMPRESSOR

CHAPTER 2

PRESSURE SETTINGS

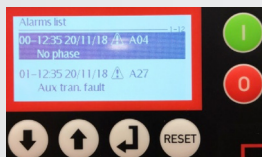
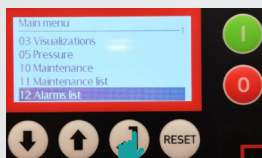
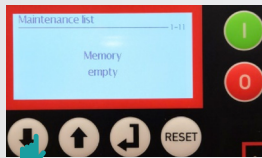
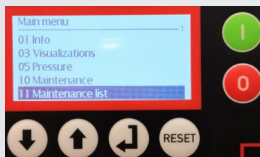

11- Maintenance List Menu: Maintenance history can be found in this menu.

12- Alarm List Menu: A list of past alarms can be found in this menu with details such as hour, date, and error code.

12- Alarm List Menu: The alarm codes and explanations can be found in section 2.13.2

MAINTENANCE

CHAPTER 3

3.1 PREVENTIVE MAINTENANCE INTERVALS

3.1.1 GENERAL DESCRIPTION

- ▶ The compressor maintenance and repairs must be carried out as described in this manual.
- ▶ Genuine Ozen parts must be used for maintenance and repairs.
- ▶ Appropriate and correct tools and implements should be used for maintenance and repairs.
- ▶ Isolate the compressor from the pressure line by closing the compressor's air discharge valve and check that the compressor has an internal pressure of 0 Psi (no pressure) on the display of the Maestro control panel.
- ▶ Disconnect the compressor from the power supply and always follow required lock-out/tag-out procedures and wear appropriate personal protective equipment (PPE) when performing any troubleshooting, maintenance, and/or repairs of the compressor. Always follow every safety precaution.
- ▶ Do not clean with any flammable solvents or ones that leave any type of residue. Cleaning should be performed with a soft, lint-free cloth and mild cleaners.
- ▶ Care should be taken to avoid leaving loose bolts, nuts and glands in the compressor after maintenance and repair. Equipment used in maintenance and repair of the compressor (screwdriver, etc.) should not be forgotten inside the compressor.
- ▶ Before performing any type of service work, you must thoroughly read and understand this manual. Failure to do so may result in voiding the warranty, personal injury, and/or equipment damage.
- ▶ For cases in which there are any issues that you cannot solve, please contact your nearest Ozen Distributor.



ATTENTION!

Maintenance of the compressor by unauthorized personnel or improperly trained personnel will void any warranty and may also result in equipment damage and/or personal injury



3.1.2 DAILY MAINTENANCE

- ▶ Check the oil level daily.
- ▶ If the oil level is low in the sight glass when the machine is off, add oil to bring it up to half in the sight glass before running the machine.
- ▶ If oil loss is frequent, there is likely a problem with the compressor. Refer to the Faults and Solutions chapter for possible causes and solutions. Contact your local Ozen Distributor for service or repair.
- ▶ In the case of air leakage, the efficiency of the compressor will decrease and the noise level will increase. Contact your local Ozen Distributor for service or repair.
- ▶ Check daily to ensure that there are no warnings and/or errors on the controller.
- ▶ Perform a visual check of the compressor for proper operation daily.
- ▶ Do not remove any components of the compressor while it is running. Always stop the compressor, relieve pressure, and observe proper safety precautions before making any adjustments while performing the daily checks.
- ▶ Check auto drain valve daily. While working, compressor should drain 2 seconds at every 1 minute.



3.1.3 WEEKLY MAINTENANCE

- ▶ Clean the air filter element with compressed air. Do not use any type of cleaning solvents.
- ▶ You should check the oil level.
- ▶ You should empty water accumulated in the air tank.
- ▶ Visually inspect the hoses for air and oil leaks.
- ▶ Check the safety valve. While compressor working, check for leaks.



MAINTENANCE

CHAPTER 3

3.1.4 COMPRESSOR MAINTENANCE INTERVALS

The maintenance intervals of the compressor are as shown in the table below.

OABR I MAINTENANCE SCHEDULE								
Maintenance Schedule	1000 hr. or 6 months	2000 hours	3000 hours	4000 hr. or 18 months	5000 hours	6000 hours	7000 hours	8000 hr. or 30 months
Oil change	✓	✓	✓	✓	✓	✓	✓	✓
Oil sponge replacement	✓	✓	✓	✓	✓	✓	✓	✓
Stage valves kit*				✓				✓
O-ring*				✓				✓
Piston ring *				✓				✓
Connection rod bearing*				✓				✓
Suction filter				✓				✓
Belt								✓
Check Valve								✓
Service Plan Code	S-A	S-A	S-A	S-B	S-A	S-A	S-A	S-C

* Check and relace if necessary.

The control panel alarm will display at each 1000 hour period for scheduled maintenance. This maintenance needs to be performed to maintain warranty and longitivity of the life of the compressor. Please contact with your local Ozen Distributor for Ozen genuine service kits and parts.

3.2. TORQUE VALUE

The following table indicates the torque values to which a torque wrench should be set for tightening the various size attaching bolts & nuts. Use these values to set a torque wrench to tighten these fasteners at intervals indicated in the MAINTENANCE TABLE.

RECOMMENDED TORQUE VALUE TABLE

Bolt	Thread	Quality class	Max torque
Bolt - allen head	M6	8.8	10.5 Nm (7.7 ft-lb)
Bolt - allen head	M8	8.8	25.3 Nm (18.7 ft-lb)
Bolt - allen head	M10	8.8	50.8 Nm (37.5 ft-lb)
Bolt - allen head	M12	8.8	86.9 Nm (64.1 ft-lb)
Bolt - allen head	M14	8.8	139 Nm (102.5 ft-lb)
Bolt - allen head	M16	8.8	213 Nm (157 ft-lb)
Pipe connections (nuts)			Hand tightness + 1/2 round

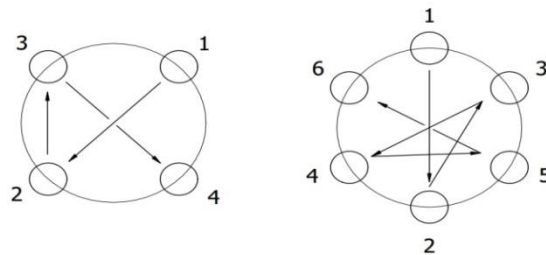

Figure 10 Tightening order

3.3. MAINTENANCE INSTRUCTIONS

Before attempting any maintenance or service work, isolate the compressor by switching off the power and blowing down the pressure inside all equipment, such as the filters, purifiers, piping, etc. If a bank system exists, isolate it by closing the appropriate valves.

MAINTENANCE

CHAPTER 3

3.3.1. OIL LEVEL CHECK

Instruction no	01
Instruction name	Oil level check
List of tools required	None
Parts list to be used in replacement kit	None

- Oil level can be visually checked through oil level glass in the front of crankcase. Oil level should be below the red line.
- Refill oil, if needed.

3.3.2. LEAK CHECK

Instruction no	02
Instruction name	Leak check
List of tools required	Bowl, sponge, soapy water
Parts list to be used in replacement kit	None

- Listen to compressor while working and check for unusual sounds.
- If there is an unusual sound, try to detect the source.
- Detect and tighten the screw, nuts, fittings, etc.
- Apply soapy water with sponge on connectors with suspected leak(s). Check if leak has been repaired by the absence of soap bubbles.
- Wipe the soapy water off of the compressor.

3.3.3. AUTO DRAIN VALVE CHECK

Instruction no	03
Instruction name	Auto drain valves check
List of tools required	None
Parts list to be used in replacement kit	None

- While working, compressor should drain for 5 seconds at every 10 minutes.

3.3.4. V-BELT TENSION CHECK

Instruction no	05
Instruction name	V-belt tension check
List of tools required	None
Parts list to be used in replacement kit	None

- Check the V-belt tension. The proper tension should allow 13 mm ($\frac{1}{2}$ ") deflection with a 1 kg (2 pounds) weight applied on the center of each belt.

3.3.5. COMPONENTS CHECK

Instruction no	06
Instruction name	Components check
List of tools required	Appropriate tools
Parts list to be used in replacement kit	None

- Stop the compressor. Make sure the compressor is cooled down.
- Appropriate tool is selected depending on the component. Tighten the component according to their individual torque values.
- Check with soapy water for leaks. Mind electrical components. Wipe the soapy water off the compressor.

3.3.6. SERPENTINES, INTERCOOLERS AND AFTERCOOLER, FLYWHEEL CLEANING

Instruction no	07
Instruction name	Serpentines, intercoolers
List of tools required	Cloth
Parts list to be used in replacement kit	None

- Clean dust on serpentines, intercoolers and aftercooler, flywheel with low pressure air. Wipe or vacuum if necessary.

3.3.7. CURRENT CHECK

Instruction no	08
Instruction name	Current check
List of tools required	Ampere meter
Parts list to be used in replacement kit	None

- Check with an ampere meter at max. load for conformity with the motor power and current data.

3.3.8. SAFETY VALVE CHECK

Instruction no	09
Instruction name	Safety valve check
List of tools required	Soapy water
Parts list to be used in replacement kit	None

- Start the compressor. While it is working, apply soapy water on valves and check for leaks. Replace valves if necessary.

MAINTENANCE

CHAPTER 3

3.3.9. SAFETY VALVE REPLACEMENT

Instruction no	09-01
Instruction name	Safety valve replacement
List of tools required	Appr. tools, soapy water
Parts list to be used in replacement kit	None

- Remove the problematic safety valve with the appropriate tool. Start the compressor and verify teflon tape parts are removed from valve hole. Then stop the compressor.
- Wrap teflon tape on the new safety valve and put it in its place and tighten with appropriate tool.
- Start the compressors. While it is working, put soapy water on valves and check for leaks.

3.3.10. CHECK VALVE INSPECTION

Instruction no	10
Instruction name	Inspect check valve
List of tools required	Appr. tools, soapy water
Parts list to be used in replacement kit	None

- Start the compressor. When purifier is pressurized, remove check valve inlet pipe. Check for leaks with soapy water. Reconnect the pipe if no leaks are present. If leaking, replace check valve.

3.3.10.1 CHECK VALVE REPLACEMENT

Instruction no	10-01
Instruction name	Check valve replacement
List of tools required	Appropriate tools, soapy water
Parts list to be used in replacement kit	None

- If check valve is leaking, remove it with appropriate tool.
- Clean its place and install the new check valve.
- Start the compressor. Check for leaks with soapy water.

3.3.11. V-BELT REPLACEMENT

Instruction no	11
Instruction name	V-belt replacement
List of tools required	Appropriate tools
Parts list to be used in replacement	None

- Stop the compressor and verify complete depressurization.
- Remove flywheel grid with appropriate tools.
- Remove belts from flywheel and install new ones. Rotate flywheel by hand to check tension.
- Reconnect flywheel grid with appropriate tools. Start the compressor and check the proper rotation.

3.3.12. OIL CHANGE

Instruction no	12
Instruction name	Oil change instructions
List of tools required	Funnel, bowl
Parts list to be used in replacement	Ozen ZenLube 100 oil

- Start the compressor and run for 5 minutes to warm up the oil. Stop the compressor.
- Remove oil cap with a no.17 wrench.
- Put a funnel and a bowl below the oil drain plug.
- Remove oil drain cap with a no.17 wrench.
- Wait until all oil is drained.
- Reinstall oil drain cap with a no.17 wrench.
- Refill with new Ozen ZenLube 100 oil.
- Reinstall oil top cap with a no.17 wrench.

TROUBLESHOOTING

CHAPTER 4

COMPRESSOR DOES NOT WORK

- | | |
|--------------------------------------|--|
| • No power | Check incoming power. |
| • Motor starter overload tripped | Start and check if trips again. If it does, check motor to include amp draw. Check electrical and motor connections. |
| • Pressure switch not making contact | Check all the terminals and wires. If pressure switch is defective, replace it. |

EXCESSIVE NOISE DURING OPERATION

- | | |
|---|--|
| • Loose sheave, flywheel, belt, belt-guard, intercooler, bolts or accessories | Detect and tighten. |
| • Faulty vibration mounts | Check if the mounts are in good condition. If damaged, replace. |
| • Lack of oil in the crankcase | a. Check for possible damage to bearings.
b. Refill oil and check if the noise persists. |
| • Piston hitting the valve plate | Remove the compressor cylinder head.
Replace the gasket with the brand new gasket and reassemble. |
| • Deflected (bent) crankshaft or crankshaft bearing failure | Replace the crankshaft. |
| • Excessive dirt or carbon on piston(s) | Remove the compressor air heads. Clean pistons and valve(s), or replace if worn. Reassemble. |

COMPRESSOR KNOCKS

- | | |
|--|---|
| • Crankshaft bearing failure | Replace bearings or crankshaft assembly. |
| • Connecting rod journal bearings worn | Replace the connecting rods. If worn, replace the crankshaft bushing center, as well. |
| • Wrist pins and journals are worn | Replace complete pin and rod assembly. |

MILKY OIL IN THE CRANKCASE

- | | |
|---|---|
| • High moisture and dirt content in the ambient air | a. Check air source for moisture.
b. Change oil more frequently. |
|---|---|

COMPRESSOR VIBRATION

- | | |
|--|--|
| • Mounting bolts are loose | Tighten the mounting bolts. |
| • Compressor not properly mounted | Level the compressor so that all feet touch the floor. |
| • Motor belt and the sheave misaligned | Align. |

EXCESSIVE OIL CONSUMPTION

• Restricted air intake	Check source air for restriction.
• Oil leaks.	Tighten bolts and fittings. Replace gaskets.
• Worn piston rings	Replace piston rings.
• Low oil viscosity	Drain oil. Refill with proper oil.
• Piston rings misassembled	If piston rings are upside down, install in proper position.
• Compressor tilted too much	Level compressor.
• Scored or worn cylinder(s)	Replace cylinders.

OIL IN DISCHARGE AIR

• Restricted air intake	Check restrictions at the inlet and check source air.
• Worn piston rings	Replace piston rings.
• Excessive oil in the crankcase	Drain to the overflow level.
• Low oil viscosity	Drain oil. Refill with proper oil.
• Piston rings misassembled	If piston rings are upside down, install in proper position.
• Consumed purifier cartridge fillingkit	Refill the purifier cartridge with refilling kit.

AIR FROM INTAKE

• Broken 1 st stg. inlet valve	Replace its spring and disc.
---	------------------------------

INSUFFICIENT AIR AT THE POINT OF USE

• Leaks or restrictions	Check for leaks and restrictions in the piping and hoses.
• Restricted air intake	Check source air for restrictions.
• Slipping belts	Tighten the belts.
• Excessive air consumption	Limit the air consumption to the capacity of the compressor.
• Worn piston rings	Increase your air capacity with an additional compressor unit.
• Worn cylinders	Replace piston rings.

PRESSURE VESSELS DO NOT HOLD THE PRESSURE WHEN THE COMPRESSOR IS UNLOADED

• Check valve leaks	Depressurize the pressure vessels and replace the check valve.
• Excessive leaks in the plant piping	Check the piping, repair the leaks.

CAUTION!

Do not service tank, valves, piping, etc. while compressed air exists in the system. Drain the air inside before attempting any repairs.

TROUBLESHOOTING

CHAPTER 4

EXCESSIVE BELT WEAR

- | | |
|-------------------------------|---|
| • Sheaves misaligned | Realign the motor sheave and the flywheel. |
| • Belts too tight | Adjust tension. |
| • Belts too loose | Adjust tension. |
| • Sheave or crankshaft wobble | Check for worn or bent crankshaft, keyway, or sheave bore |

EXCESSIVE DISCHARGE AIR TEMPERATURE

- | | |
|--|--|
| • Dirty valves / carbon on valves | Remove valves. Clean or replace. |
| • Dirty intercoolers and/or cooling surfaces | Clean cooling surfaces of the cylinders, intercoolers and aftercooler. |
| • Poor ventilation and air circulation | Relocate the compressor, improve ventilation. |
| • Blown head gasket | Replace the head gasket. |
| • Restricted air intake | Check source air for restrictions. |
| • Worn valves | Repair or replace valves. |
| • Compressor rotating in the wrong direction | Correct the direction of rotation. |
| • Low oil level | Check and refill. |

AIR LEAKING FROM THE INTERSTAGE SAFETY VALVE

- | | |
|---|--------------------------------------|
| • Safety valve faulty | Replace the safety valve. |
| • Inlet valve of the next stage leaks | Remove the valves. Clean or replace. |
| • Inlet valve of the next stage is broken | Remove the valves and replace. |

PRESSURE SLOWLY RISING

- | | |
|---------------------------|----------------------------------|
| • Restricted air intake | Check source air. |
| • Blown cylinder gasket | Install a new gasket. |
| • Worn or broken valves | Replace valves. |
| • Air leaks in the system | Check for leaks, fix the problem |
| • Loose belts | Adjust tension. |
| • Low compressor speed | Check RPM. |

COMPRESSOR DOES NOT DISCHARGE WHEN STOPPED

- | | |
|----------------------------------|--|
| • Automatic drain valves blocked | Check, disassemble, and clean the drain valves. Install new o-ring and seat, if necessary. |
| • Solenoid valve faulty | Check and replace solenoid valve. |

RECEIVER PRESSURE RISING TO FAST	
• Water in the system	Drain the system more often.
• High compressor speed	Check RPM.
AUTO DRAIN VALVES DO NOT OPEN	
• Condensate drain valve piston jammed	Dismantle drain valve, clean or replace valve.
AUTOMATIC DRAIN VALVE(S) REMAIN(S) OPEN ALL THE TIME	
• Low 2nd stg. control air pressure	Check the interstage pressures.
• Solenoid valve faulty	Replace solenoid valve.
• Blocked drain valve(s)	Clean the drain valve(s).
COMPRESSOR DOES NOT ACCESS NOMINAL OPERATING SPEED	
• Low voltage	Check the line voltage.
• Motor and control panel connectors loosen	Check connections and tighten if needed.
• Poor power regulation (unbalanced phases)	Notify the power company.
UNUSUAL PISTON, RING OR CYLINDER WEAR	
• Improper oil	Replace with the proper oil.
• Low oil level	Check the oil level and fix the problem, refill oil.
• Extremely dirty ambient conditions	Pipe the intake filter to a cleaner location, if possible.
ODOR IN COMPRESSED AIR	
• Purifier cartridge saturated	Replace the cartridge.
• Improper oil	Replace with the proper oil.
• Wrong direction of rotation	Check the arrow: the compressor flywheel must blow air onto the cylinders. If the direction of rotation is wrong, reverse the phases and ensure it is running in the right direction.
• Carbonization on valves	Clean and make sure that the ambient temperatures are within permissible limits.

WIRING DIAGRAM

CHAPTER 5

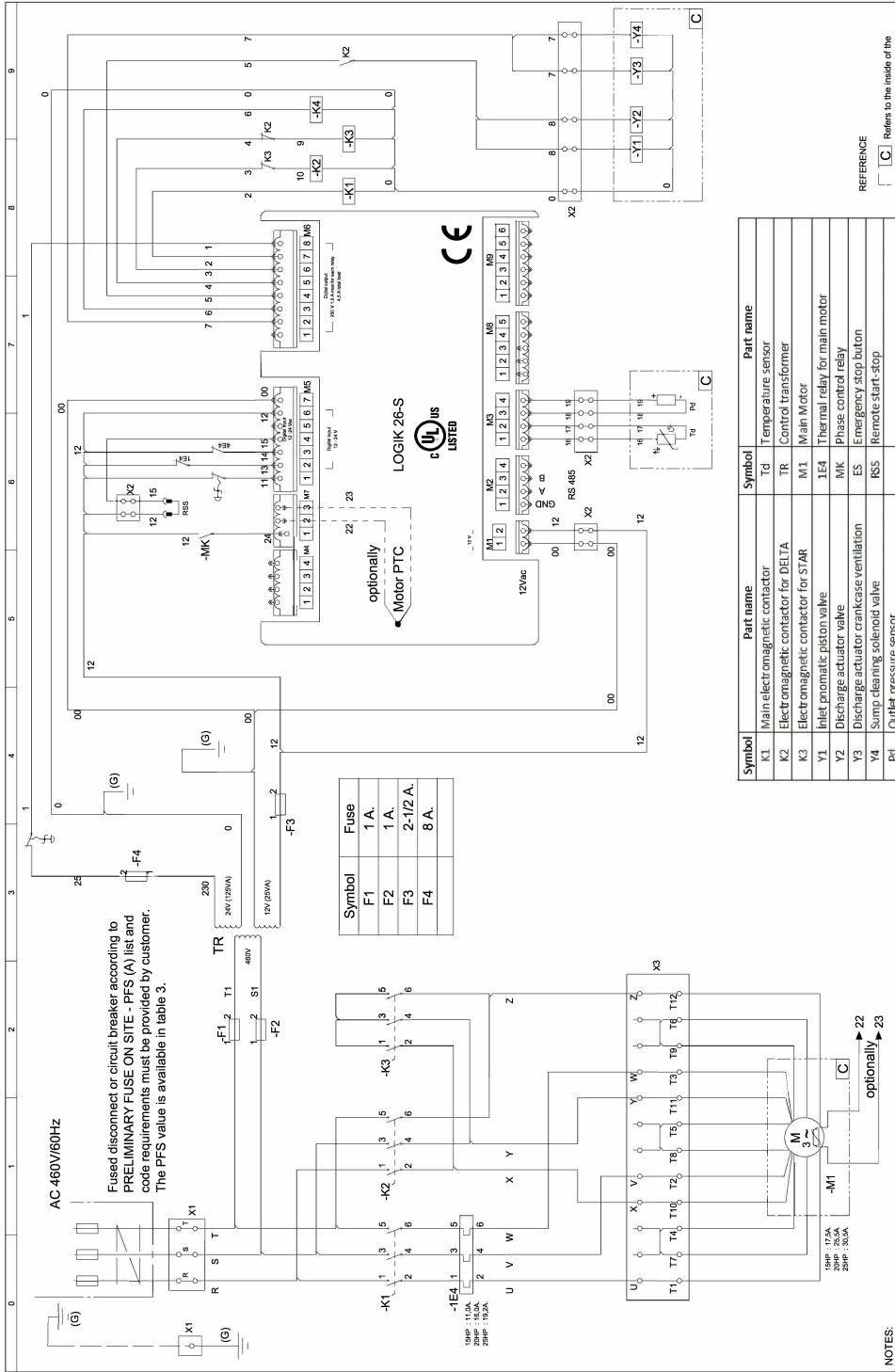

NOTES:
 1. SIZING OF ELECTRICAL COMPONENTS NOT SUPPLIED BY OZEN IS THE RESPONSIBILITY OF THE CUSTOMER.
 2. RATED DRY CONTACT IS AC/DC24V. 1A. (MAX).

Symbol	Part name	Symbol	Part name
K1	Main electromagnetic contactor	Td	Temperature sensor
K2	Electromagnetic contactor for DELTA	TR	Control transformer
K3	Electromagnetic contactor for STAR	M1	Main Motor
Y1	Inlet pneumatic piston valve	IE1	Thermal relay for main motor
Y2	Discharge actuator valve	MK	Phase control relay
Y3	Discharge actuator crankcase ventilation	E5	Emergency stop button
Y4	Sump cleaning solenoid valve	RSS	Remote start-stop
P4	Outlet pressure sensor		

REFERENCE
 [C] Refers to the inside of the air compressor, but not in the control panel.

Delgi/Albador	Trinh	lham	Norm	Control	2018-04-11		Sub.t.	460V/60Hz	Piston Booster OABR 1 Maestro 22	Wiring Diagram	Sub.b.		4	Ver 21	Trinh	30	35
	Ozen	Manat OZGUR															
	Trinh	2018-04-11															



Ozen Compressed Air Technology and Equipment, LLC.
4205 Golf Acres Drive Charlotte NC 28208
(704) 660-0334
info@ozenairtech.com

