

P4200W Series Air Dryer



User's Guide

Models covered:

P4200W P4200WLP P4202W P4202WLP





WARNING:

This product can expose you to chemicals including Lead, which is known to the State of California to cause cancer/birth defects or other reproductive harm. For more information go to www.P65Warnings.ca.gov

1. Welcome & Congratulations

Congratulations on your purchase of a new ALTEC AIR P4200W Series Air Dryer! We here at ALTEC AIR are very proud of our products and we are committed to providing you with the best value and service possible.

We are sure that you will be satisfied with your new air dryer and would like to thank you for choosing ALTEC AIR for your air dryer requirements. We also hope that you will continue to choose us for your future air pressure and related product purchases.

For information about this and other ALTEC AIR products, please visit us on the web at:

www.AltecAIR.com

2. Introduction

PLEASE READ THIS USER'S GUIDE THOROUGHLY AND SAVE FOR FUTURE REFERENCE.

This User's Guide is provided for the benefit of our customers and contains information and direction specific to the ALTEC AIR P4200W Series Air Dryer. Models covered include P4200W, P4200WLP, P4202W, and P4202WLP. It will cover topics including safety, specifications, installation, registration, operation, testing, maintenance, replacement parts, service, and troubleshooting issues. Observation and compliance with this User's Guide will ensure the maximum life and efficiency of your air dryer.

This User's Guide should be read thoroughly prior to installing, operating, or servicing the air dryer in order to become familiar with the recommended procedures. This will minimize the possibility of personal injury or damage to the unit due to improper operation or handling.

3. Table of Contents

1. Welcome & Congratulations	3	8.12 Depressurizing the Dryer	53
2. Introduction	3	8.13 Connecting to Common Alarm Socket	53
3. Table of Contents.....	4	8.14 Setting the System Pressure	54
4. Safety & Warning Information	6	8.15 Setting the Static Pressure.....	55
5. Overview & Specifications.....	9	8.16 Setting the Outlet Pressure.....	56
5.1 Product Description	9	8.17 Connecting via Web Browser	57
5.2 Key Features	9	8.18 Using the Status Screen	58
5.3 P4200W Series Air Dryer Models	9	8.19 Using the Setup Screen.....	61
5.4 Technical Specifications.....	10	8.20 Using the Event Screen.....	63
5.5 Dryer Function Overview	11	8.21 Using the Firmware Screen.....	64
6. Installing Your Dryer	12	8.22 Connecting via SNMP	65
6.1 Safety & Warning Information	12	9. Testing Your Dryer	66
6.2 Before You Begin.....	13	9.1 Safety & Warning Information	66
6.3 Included Contents	14	9.2 Measuring Compressor Amp Draw	67
6.4 Required Tools and Materials.....	14	9.3 Measuring Voltage to Compressor	68
6.5 Installation Steps.....	15	9.4 Measuring Incoming Voltage	69
6.6 Installation Checklist	22	9.5 Measuring Voltages at Solid State Relay	
7. Registering Your Dryer.....	23	70
8. Operating Your Dryer	24	9.6 Testing Consistent Heatless Dryer	
8.1 Safety & Warning Information	24	Cycling.....	71
8.2 Connecting an Air Line to the Dryer	25	9.7 Testing Unloader Valve	72
8.3 Powering the Dryer ON & OFF.....	25	9.8 Measuring Heatless Dryer Solenoid	
8.4 Using the Front Panel Display	26	Voltage.....	73
8.5 Identifying Dryer Alarms	29	9.9 Testing Precooler Fan	75
8.6 Accessing the Setup Menu.....	33	9.10 Testing Safety Relief Valve	75
8.7 Using the System Setup Menu.....	34	9.11 Testing Compressor ON/OFF Cycling	76
8.8 Using the Alarm Setup Menu	40	9.12 Testing Compressor Last Run Time	
8.9 Using the Network Setup Menu.....	46	Alarm	77
8.10 Removing the Front Panel	52	9.13 Testing Humidity Alarm and System	
8.11 Removing the Top Cover.....	52	Shutdown	78
		9.14 Testing High Outlet Pressure Alarm....	80
		9.15 Testing Low Outlet Pressure Alarm....	82
		9.16 Testing Air Fittings & Hoses for Leaks	
		83

10. Maintaining Your Dryer	85	13.12 High Cabinet Temperature Alarm.....	104
10.1 Safety & Warning Information	86	13.13 Inconsistent Heatless Dryer Cycling	105
10.2 Six Month Maintenance.....	88	13.14 Compressor Doesn't Operate	105
10.3 8,000 Hour Maintenance	89	13.15 Compressor Won't Build Pressure...	105
11. Replacement Parts & Accessories	90	13.16 Compressor Excessive AMP Draw..	106
11.1 Top Section Parts	90	13.17 Compressor Last Run Time Alarm ..	106
11.2 Middle & Lower Section Parts 1	91	13.18 Can't Create a Compressor Last Run	
11.3 Middle & Lower Section Parts 2	92	Time Alarm.....	107
11.4 Heatless Dryer Assembly Parts.....	93	13.19 Compressor Rapid ON/OFF Cycling	
11.5 Frame Section Parts	94	107
11.6 Accessories for Your Dryer	95	13.20 Contacting ALTEC AIR Technical	
Ordering Parts from ALTEC AIR	96	Support.....	108
12. Service & Repair.....	97	14. Appendix	109
12.1 Services Offered	97	14.1 Wiring Diagram	109
12.2 Initiating a Service Transaction	97	14.2 Operational Limits and Defaults	110
13. Troubleshooting Your Dryer	98	14.3 SNMP Parameters.....	111
13.1 Before You Call ALTEC AIR	98	15. Limited Warranty Agreement.....	112
13.2 Safety & Warning Information	98	Registration Reminder	112
13.3 Air Dryer Won't Power ON.....	100	16. Contacting ALTEC AIR	113
13.4 Display Screen Not Functioning	100	16.1 General.....	113
13.5 High Outlet Pressure Alarm.....	100	16.2 Sales.....	113
13.6 Can't Create a High Pressure Alarm..	101	16.3 Service	113
13.7 Low Outlet Pressure Alarm	101	16.4 Technical Support.....	113
13.8 Can't Create a Low Pressure Alarm ..	102	17. Notes.....	114
13.9 High Flow Rate Alarm.....	102		
13.10 High Humidity	103		
13.11 Can't Create a High Humidity Alarm /			
Shutdown.....	104		

4. Safety & Warning Information

This section contains general information about safety and warning points to consider and adhere to during installation, operation, and maintenance of your air dryer. **PLEASE READ THIS SECTION BEFORE PERFORMING ANY OPERATION OR PROCEDURE ON YOUR AIR DRYER.**

Additional warnings specific to an operation or procedure will also be presented throughout the following sections. These will include the  symbol as well as a label of “**WARNING!**”, “**CAUTION!**”, or “**IMPORTANT!**”. Please be sure to pay close attention for these warnings and read them as you encounter them.



WARNING!

For your safety, all the information in this User's Guide must be followed to minimize the risk of electrical shock, and prevent property damage or personal injury.



WARNING!

Extreme care should be exercised to avoid contact with live electrical circuits. Many procedures performed during installation, operation, testing, and maintenance of this air dryer require the equipment to be running, creating a situation for potential electrical shock. It is highly recommended that you remove all jewelry before performing any procedures.

**WARNING!**

Internal surfaces may be hot. Use care when coming into contact with internal components as there is a potential for some of these components to become hot when in operation or standby.

**WARNING!**

High Noise. ALTEC AIR air dryers are meant to be installed in an unattended area.

**CAUTION!**

Proper Installation & Maintenance as outlined in this User's Guide is extremely important to ensure the reliability and longevity of the equipment as well as prevent damage or personal injury.

**CAUTION!**

Depressurizing the air dryer may be necessary before performing certain procedures. **NEVER** remove pressure sensing tubes from the Control Board without depressurizing the air dryer first, or **damage to the Control Board will occur.**

**CAUTION!**

Incoming power to dryer must be:

- 15 amp service recommended
- 110 - 125 VAC, 50/60 Hz for P4200W & P4200WLP models
- 220 - 230 VAC, 50/60 Hz, 1 Phase for P4202W & P4202WLP models

**IMPORTANT!**

Performing routine maintenance as outlined in the *Maintaining Your Dryer* section will ensure optimal performance over the lifecycle of your air dryer.

**IMPORTANT!**

Performing procedures not described in this User's Guide or installing components not supplied by ALTEC AIR is **NOT RECOMMENDED AND MAY VOID THE WARRANTY.**

**CAUTION!**

This Air Dryer does not contain an internal Surge Protection Device (SPD). If an SPD is required it must be supplied by the user.

**CAUTION!**

Observe precautions for handling **Electrostatic Sensitive Devices.**

**IMPORTANT!**

Installation of ALTEC AIR air dryers are intended for network telecommunication facilities (non-customer premises) only.

5. Overview & Specifications

5.1 Product Description

The P4200W Series Air Dryer from ALTEC AIR is designed to intake wet ambient air and remove the moisture for delivery to applications requiring a constant, on-demand source of dry, pressurized air. This process is fully automatic and will remain consistent with minimal required periodic maintenance. This dryer is designed specifically for indoor use.

The P4200W Series Air Dryer employs a fully digital operating platform offering the most accurate readings of dryer variables, removable access panels allowing easier access for adjustment and maintenance, and ultra quiet compressors with an industry leading maintenance interval of 8,000 hours.

5.2 Key Features

- LCD display of all operating parameters
- Solid state microprocessor-based circuitry eliminates costly maintenance
- Accurate humidity sensing within $\pm 0.1\%$ RH
- Quietest dryer on the market
- Pressure Ranges from 5 – 20 PSIG (35-138 KPa) or 0.3 – 10 PSIG (2-69 KPa) (LP Models)
- Remote alarm reset capabilities
- SNMP communication compatible
- Remote access through HTML interface
- Oil-less compressor with 8,000 hour maintenance interval

5.3 P4200W Series Air Dryer Models

Model	Description
P4200W	110 - 125 VAC, Standard Pressure 5 - 20 PSIG (35-138 KPa)
P4200WLP	110 - 125 VAC , Low Pressure 0.3 - 10 PSIG (2-69 KPa)
P4202W	220 - 230 VAC , Standard Pressure 5 - 20 PSIG (35-138 KPa)
P4202WLP	220 - 230 VAC , Low Pressure 0.3 - 10 PSIG (2-69 KPa)

5.4 Technical Specifications

	P4200W	P4200WLP	P4202W	P4202WLP
Output Capacity	Normal: 2,600 SCFD Maximum: 4,200 SCFD (74 SCMD Maximum 119 SCMD)			
Power Requirements	110 - 125 VAC, 1 Phase, 50 / 60 Hz		220 - 230 VAC, 1 Phase, 50 / 60 Hz	
Running Amps	8.6 Amps (15 Amp service recommended)		3.9 Amps (15 Amp service recommended)	
Outlet Pressure Range	5 – 20 PSIG (35-138 KPa)	0.3 – 10 PSIG (2-69 KPa)	5 – 20 PSIG (35-138 KPa)	0.3 – 10 PSIG (2-69 KPa)
Outlet Air Humidity	Less than 2% RH			
Compressor	2-cylinder, 3/4 HP, oil-less type compressor			
Drying Method	Heatless Desiccant			
Operating Temperature Range	40° to 85° F (optimal) 5° to 30° C (optimal)			
Noise Level:	63 dBA @ 3'			
Heat Dissipation	3,500 BTU / hr		2,900 BTU / hr	
Alarms	Standard alarms – complete readings of all critical measurement points, individual alarm indication display			
Monitoring	Web Browser and SNMP compatible communications via Network IP			
Outlet Connections	1/2" NPT Female			
Dimensions	21" D x 25.25" W x 49" H			
Net / Shipping Weight	222 lbs / 278 lbs 100 kgs/126 kgs			

5.5 Dryer Function Overview

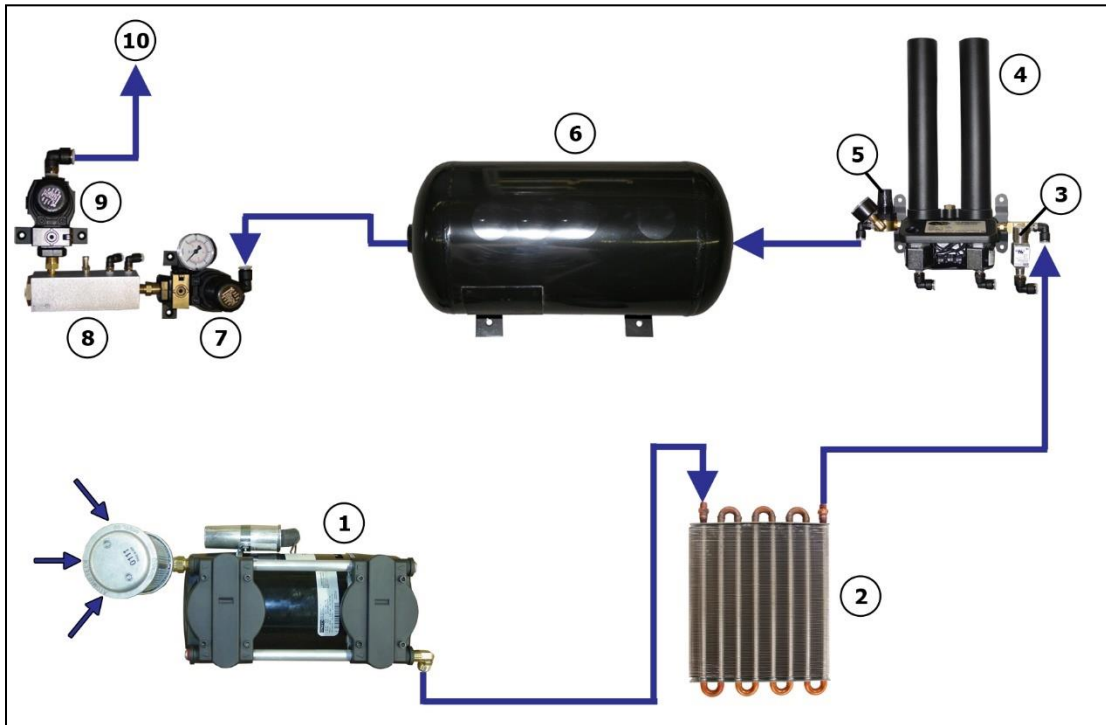

#	Component	Description
1	Compressor	Compresses drawn in ambient air.
2	Precooler	Cools compressed air prior to drying function.
3	Unloader Valve	Relieves excess Compressor head pressure.
4	Heatless Dryer	Removes moisture from compressed air.
5	Capacity Control Valve	Regulates System Pressure (50 PSI/345 KPa) and prevents air from bleeding back through the Heatless Dryer.
6	Air Tank	Stores dry compressed air.
7	Static Pressure Regulator	Regulates the Static Pressure (20 PSI/138 KPa) and maintains constant pressure on the Combo Block for accurate Flow measuring.
8	Combo Block	Measures the Flow of compressed air and houses the Humitter.
9	Outlet Pressure Regulator	Regulates the Outlet Pressure.
10	Pressure Outlet	Outputs the pressure set by the Outlet Pressure Regulator.

6. Installing Your Dryer

6.1 Safety & Warning Information



WARNING!

Internal surfaces may be hot. Use care when coming into contact with internal components as there is a potential for some of these components to become hot when in operation or standby.



WARNING!

Extreme care should be exercised to avoid contact with live electrical circuits. Many procedures performed during installation, operation, testing, and maintenance of this air dryer require the equipment to be running, creating a situation for potential electrical shock. It is highly recommended that you remove all jewelry before performing any procedures.



WARNING!

High Noise. Altec AIR air dryers are meant to be installed in an unattended area.



CAUTION!

Proper Installation & Maintenance as outlined in this User's Guide is extremely important to ensure the reliability and longevity of the equipment as well as prevent damage or personal injury.



CAUTION!

This Air Dryer does not contain an internal Surge Protection Device (SPD). If an SPD is required it must be supplied by the user.

**IMPORTANT!**

Performing procedures not described in this User's Guide or installing components not supplied by ALTEC AIR is NOT RECOMMENDED AND MAY VOID THE WARRANTY.

**IMPORTANT!**

Installation of ALTEC AIR air dryers are intended for network telecommunication facilities (non-customer premises) only.

6.2 Before You Begin

6.2.1 Carefully inspect the unit, including the shipping box as well as the air dryer, for ANY DAMAGE CAUSED BY SHIPPING. If any shipping damage is detected, it is important to file a claim with the shipping company prior to continuing the installation procedures.

6.2.2 Read the entire *Installing Your Dryer* section to familiarize yourself with the components and procedures before performing the air dryer installation.

6.2.3 Verify the installation location of the air dryer:

6.2.3.1 Well ventilated and free from abrasive dust or chemicals.

6.2.3.2 Ambient temperature is between 40° and 85° F (optimal).

NOTE: Higher temperatures will decrease component lifespan.

6.2.3.3 Meets the following power requirements:

- 110 - 125 VAC for P4200W and P4200WLP models
- 220 - 230 VAC, 1 Phase for P4202W and P4202WLP models
- All models require 50/60 Hz and minimum 15 amp service.

6.2.4 Notify the alarm center of the installation and potential for alarms during the process (as necessary).

6.3 Included Contents

(1) P4200W Series Air Dryer

(1) Installation Guide (not shown)

Package located inside the dryer:

(2) Alarm Connector

(1) User's Guide (not shown)

(1) Purge Muffler



(1) Compressor Connector Tool

(1) Power Cord

6.4 Required Tools and Materials

- Large adjustable wrench
- Medium adjustable wrench
- 7/16" wrench
- Band cutters or snips
- Pipe dope or pipe thread tape
- Cup of soapy water
- 1-inch paint brush
(recommended)

6.5 Installation Steps

6.5.1 Remove all shipping materials.

NOTE: If ANY SHIPPING DAMAGE is detected, file a claim with the shipping company prior to continuing the installation procedures.

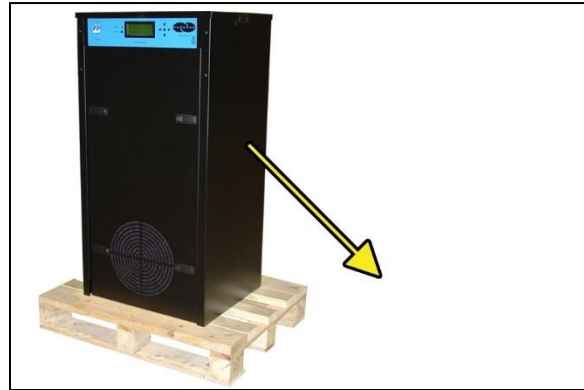

6.5.2 Place the dryer at the operating location.

6.5.3 Remove the Front Panel.

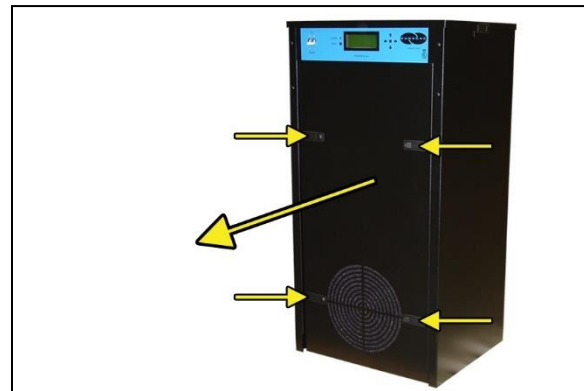

6.5.4 Check for loose parts, hoses, or wiring.

NOTE: If ANY SHIPPING DAMAGE is detected, file a claim with the shipping company prior to continuing the installation procedures.

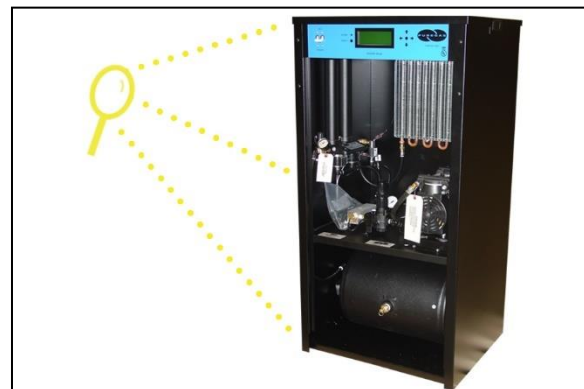

- 6.5.5** Using a 7/16" wrench, remove the shipping block from under the Compressor Plate.

Discard block and bolt.

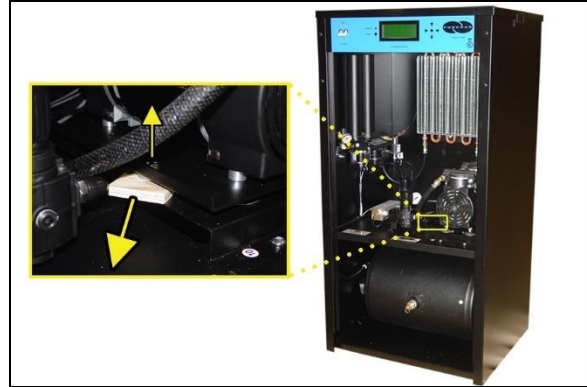

- 6.5.6** Remove the ship-loose contents package.



On BACK of dryer:

- 6.5.7** Verify that the Red Orifice Plug is still installed where shown.

- 6.5.8** Install the Purge Muffler (optional).

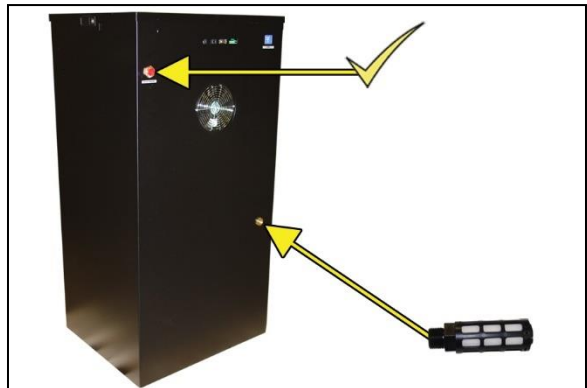

- 6.5.9** Verify that the dryer is powered **OFF**.

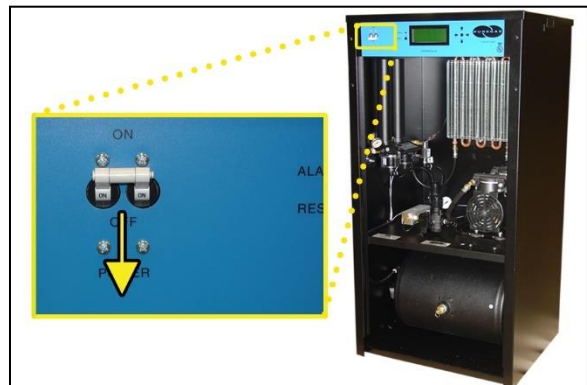

6.5.10 Plug the AC Power Cord into the dryer.

6.5.11 Plug in or wire the Power Cord to an outlet:

- 110 - 125 VAC power outlet for P4200W and P4200WLP model
- 220 – 230 VAC, 1 phase, power outlet for P4202W & P4202WLP models.

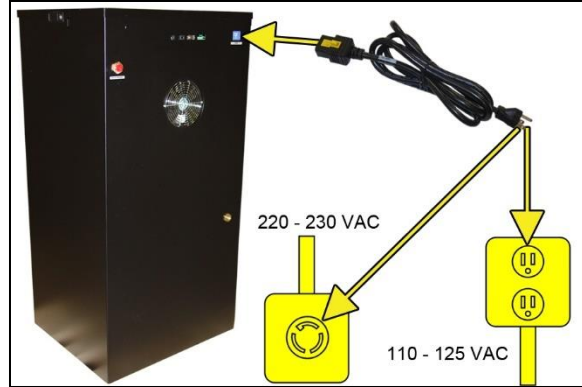

6.5.12 Power the dryer ON.

NOTE: The Compressor and Heatless Dryer will start, creating air flow through the Red Orifice Plug.

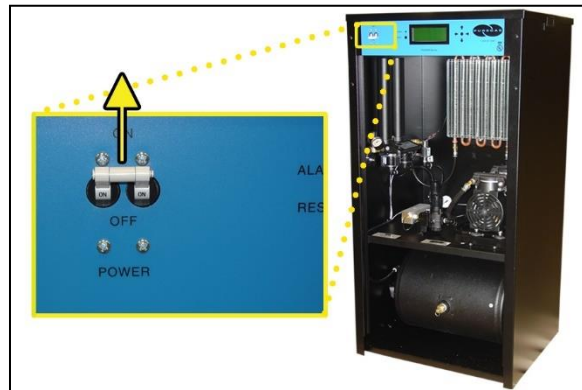

6.5.13 Set the System Pressure:

With Compressor running:

6.5.13.1 Pull the Capacity Control Valve knob out.

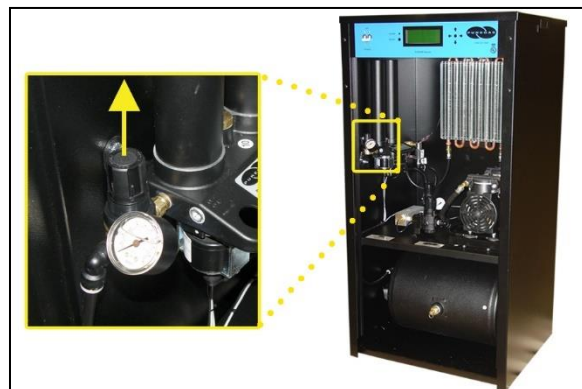

6.5.13.2 Turn the knob until the reading on the Pressure Gauge is **50 PSI (345 KPa)**.

6.5.13.3 Push the knob in to lock.

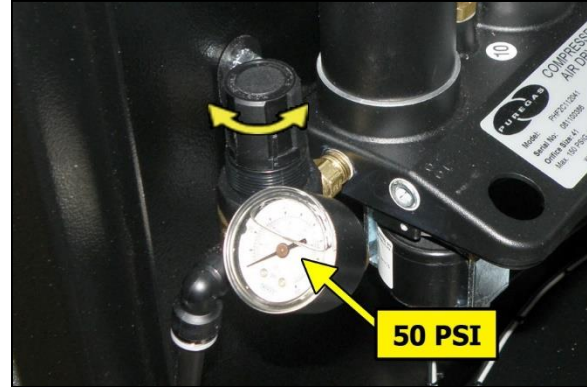

6.5.14 Let the dryer run until the Humidity drops below 2% (may take up to 15 minutes).

NOTE: Press **RESET** if the dryer goes into **SHUTDOWN**.

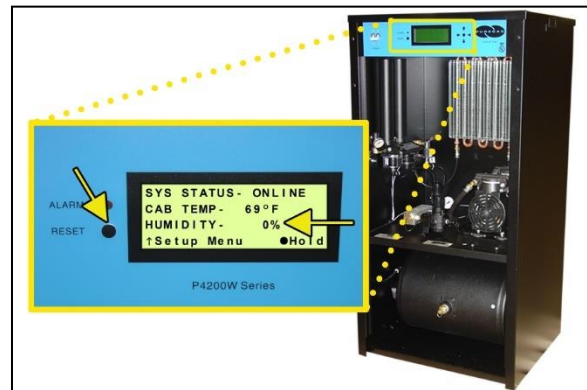

6.5.15 Power the dryer **OFF**.

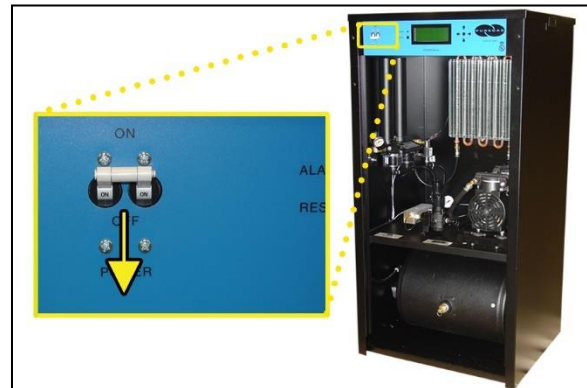

6.5.16 Remove the Red Orifice Plug from the Outlet Pressure Port.

⚠ CAUTION: Be careful when removing plug. System may be pressurized.



6.5.17 Connect the air supply line to the Outlet Pressure Port.

ALTEC AIR recommends using Installation Kit P011752 to connect your air dryer to the air supply line (See section 11.6 for detail).

6.5.18 Power the dryer ON.

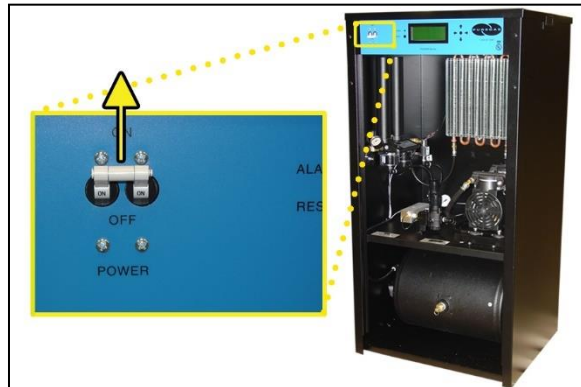

6.5.19 Set the Static Pressure:

6.5.19.1 Pull Static Pressure Regulator knob out.

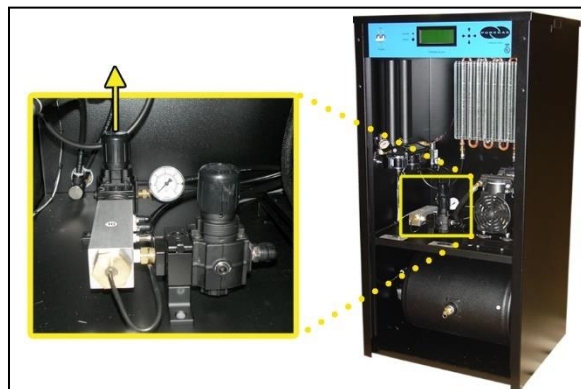

6.5.19.2 Turn knob until the reading on the Pressure Gauge is **20 PSI (138 KPa)**.

6.5.19.3 Push knob in to lock.

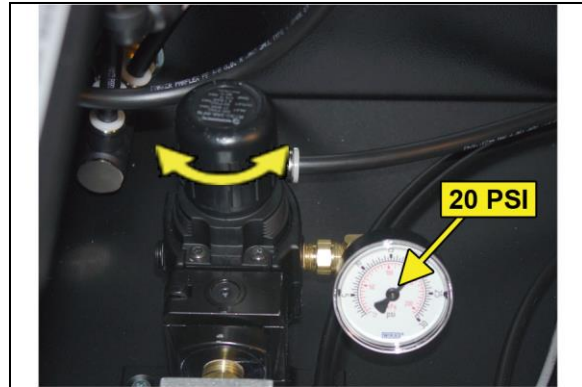

6.5.20 Set the Outlet Pressure:

6.5.20.1 Pull the Outlet Pressure Regulator knob out or loosen the retaining nut (LP models).

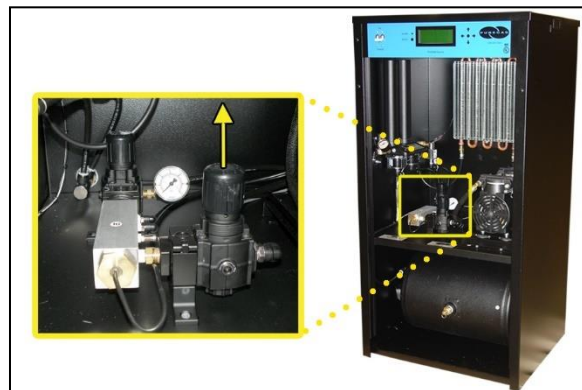

6.5.20.2 Turn knob until Outlet Pressure (**OUTLET**) reading is at the desired setting.

6.5.20.3 Push knob in to lock or tighten retaining nut (LP models).



6.5.21 Check for air leaks:

NOTE: This is a general procedure that can be applied to any fitting or hose that has air pressure in it. **DO NOT SOAP TEST THE HUMIDITY SENSOR FITTING. DAMAGE TO THE SENSOR MAY OCCUR.**

With Compressor NOT running:

6.5.21.1 Listen for any 'hissing' sounds which may indicate a fitting or hose air leak.

With Compressor running:

6.5.21.2 Use a 1-inch paint brush to dab soapy water on the air fitting or hose connection to be tested.

If air bubbles appear at the connection, this indicates that air is leaking from the connection.



If any leaks are detected, take steps to seal them off (as necessary):

- *Tighten the fitting*
- *Re-connect the hose end*
- *Replace the fitting / hose / component*

6.5.22 Re-install the Front Panel.



6.5.23 Connect a Common Alarm (as required):

- 6.5.23.1** Insert the included Alarm Connector into either of the two (2) Alarm Ports.



- 6.5.23.2** Wire an external alarm wire pair to the Alarm Connector as required:

- **Common** and **N.C.** for OPEN ON ALARM operation.
- **Common** and **N.O.** for CLOSE ON ALARM operation.

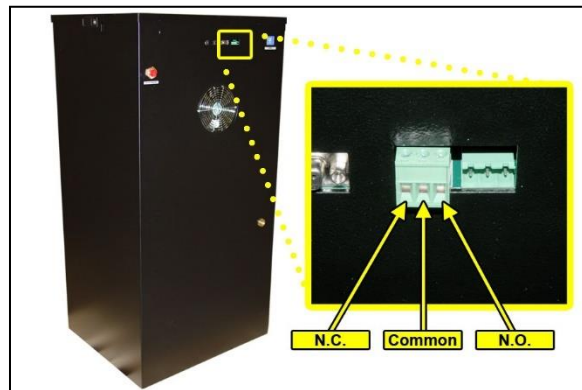

6.5.24 REGISTER YOUR DRYER. *See section 7 for details.*

6.6 Installation Checklist

- No shipping damage was detected.
- Dryer location meets the following requirements:
 - Well ventilated
 - Free from abrasive dust or chemicals
 - Ambient temperature is between 40° and 85° F (optimal)
- Shipping block removed from Compressor Tray.
- System Pressure is set to 50 PSI (345 KPa).
- Static Pressure is set to 20 PSI (138 KPa).
- No air leaks are present in the system.
- No alarms are present on the Display Panel.

7. Registering Your Dryer

Please take a moment to register your ALTEC AIR P4200W Series Air Dryer. Registering is necessary to activate the Limited Warranty on your product. Once you register, you are eligible to receive free technical support, as well as updates concerning your ALTEC AIR products.

Register Online at www.AltecAIR.com/registration

Or by Phone 1-800-521-5351 (option 2)

Have the following information available:

Model #: _____ **Serial #:** _____

Company Name: _____ **Location Name:** _____

Shipping Address: _____

City: _____ **State:** _____ **Zip Code:** _____

Contact Name: _____ **Phone #:** () - ext. _____

Email: _____

8. Operating Your Dryer

8.1 Safety & Warning Information



WARNING!

Extreme care should be exercised to avoid contact with live electrical circuits. Many procedures performed during installation, operation, testing, and maintenance of this air dryer require the equipment to be running, creating a situation for potential electrical shock. It is highly recommended that you remove all jewelry before performing any procedures.



WARNING!

Internal surfaces may be hot. Use care when coming into contact with internal components as there is a potential for some of these components to become hot when in operation or standby.



WARNING!

High Noise. Altec AIR air dryers are meant to be installed in an unattended area.



CAUTION!

Observe precautions for handling **Electrostatic Sensitive Devices.**



IMPORTANT!

Performing procedures not described in this User's Guide or installing components not supplied by ALTEC AIR is **NOT RECOMMENDED AND MAY VOID THE WARRANTY.**

8.2 Connecting an Air Line to the Dryer

- 8.2.1** Remove the Red Orifice Plug from the Outlet Pressure Port.

 **CAUTION:** Be careful when removing plug. System may be pressurized.



- 8.2.2** Connect the air supply line to the Outlet Pressure Port.

*ALTEC AIR recommends using Installation Kit **P011752** to connect your air dryer to the air supply line (See section 11.6 for detail).*

8.3 Powering the Dryer ON & OFF



CAUTION!

Incoming power to dryer must be:

- 15 amp service recommended
- 110 - 125 VAC, 50/60 Hz for P4200W & P4200WLP models
- 220 - 230 VAC, 50/60 Hz, 1 Phase for P4202W & P4202WLP models

8.3.1 Power Circuit Breaker -
Controls the main power to the dryer.

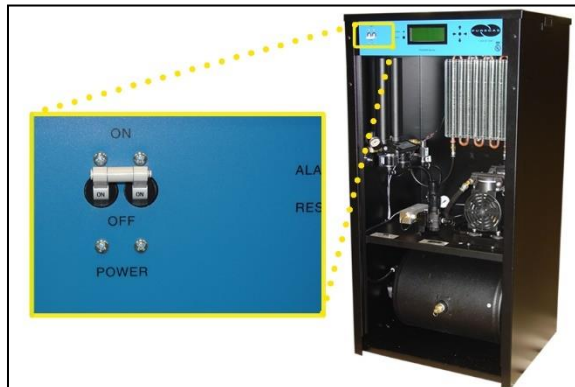

8.4 Using the Front Panel Display



CAUTION!

The Display Screen is covered by a clear protective layer that guards against Electrostatic Discharge (ESD). DO NOT REMOVE THIS LAYER.

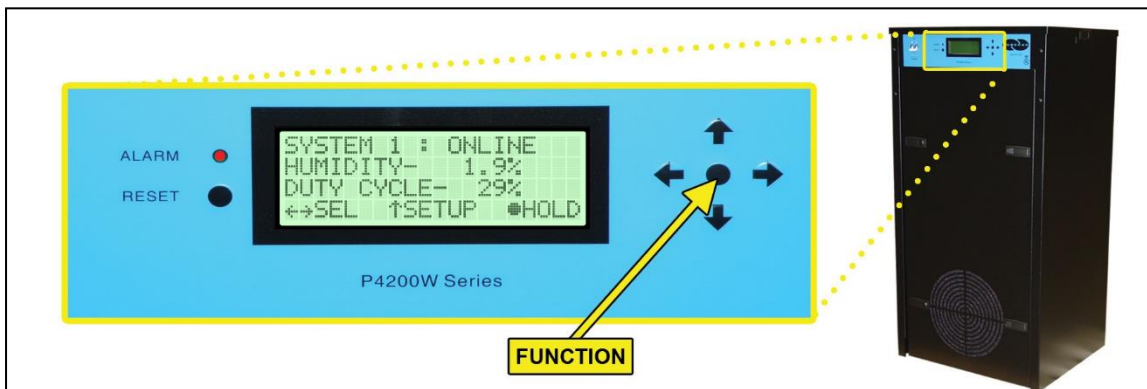

8.4.1 ALARM LED – Indicates an alarm is present.

8.4.2 RESET Button – Clears an alarm and allows the system to continue operating.

8.4.3 FUNCTION Button –

- Acts as a **HOLD** button to freeze the current information screen on the display. When pressed again, it will allow the information screens to begin cycling again.
- Acts as an **ENTER** button in the Setup Menu screens.

8.4.4 Arrow Buttons – Used to access, navigate, and change values in the Setup Menu screens.

8.4.5 Contrast Adjust – On the back of the LCD there is a knob to adjust the contrast of the display. You may adjust this knob if your display is too light or too dark.

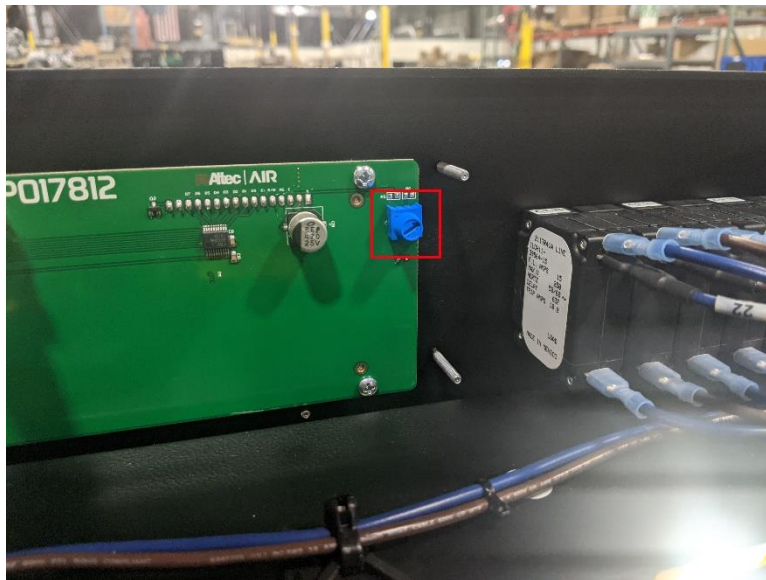

8.4.6 Display Screen - Shows the current dryer readings. Will cycle between the following three (3) information screens (unless the **HOLD** button has been pressed):

8.4.6.1 Sys Status Screen

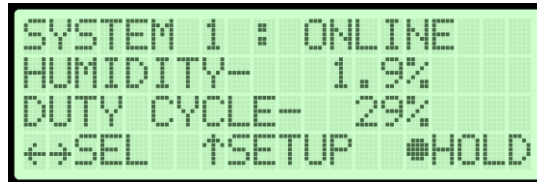

```
SYSTEM 1 : ONLINE
HUMIDITY- 1.9%
DUTY CYCLE- 29%
←→SEL ↑SETUP #HOLD
```

SYS STATUS - Running Status of the system:

- **ONLINE** – System is Online.
- **SHUTDOWN** – System has been shutdown as a result of either a High Humidity or High Cabinet Temperature alarm.

•
HUMIDITY – Humidity level of the system.

Duty Cycle – Percent of time compressor ran during last cycle.

8.4.6.2 Outlet Screen

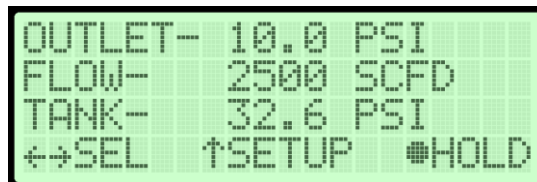

```
OUTLET- 10.0 PSI
FLOW- 2500 SCFD
TANK- 32.6 PSI
←→SEL ↑SETUP #HOLD
```

OUTLET – Outlet Pressure regulated by the Outlet Pressure Regulator.

FLOW – Air Flow Rate.

TANK – Air Tank Pressure - fluctuates between 25 – 50 PSI (172-345 KPa).

8.4.6.3 Compressor Run Time Screen

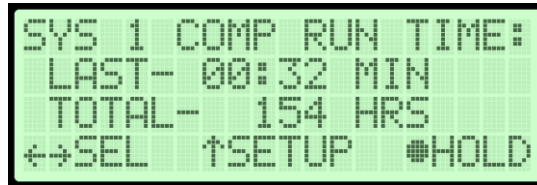

```
SYS 1 COMP RUN TIME:
LAST- 00:32 MIN
TOTAL- 154 HRS
←→SEL ↑SETUP ●HOLD
```

LAST – How many minutes the Compressor ran during the last Air Tank pressurization cycle.

TOTAL – How many hours the Compressor has run since the last Compressor Total Time Reset.

8.4.6.4 Unit in Standby Screen

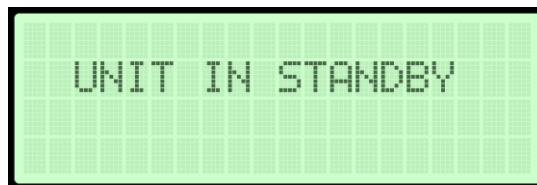

```
UNIT IN STANDBY
```

Occurs when the dryer is connected to a Cycle Kit and has been switched to Standby Mode.

8.5 Identifying Dryer Alarms

8.5.1 High Cabinet Temperature Alarm -

Occurs when the temperature in the dryer cabinet (**CAB TEMP**) rises above 115°F for more than one (1) minute. If the temperature rises above 120°F for more than one (1) minute, the air dryer will go into **SHUTDOWN** mode to protect against damage due to overheating.

This screen will be displayed, showing the Date and Time that the alarm occurred.

```

SHUTDOWN
HIGH CAB TEMP
01/14/2019 05:08
●INFO
  
```

8.5.1.1 Press the Info (●) Button to see the detail of the alarm.

```

TEMPERATURE:
COMP- 103.5°F
CABINET-140.3°F ALR
←→SEL ↑SETUP ●HOLD
  
```

See section 13.12 for troubleshooting information.

8.5.2 High Humidity Alarm –

Occurs when the Humidity level (**HUMIDITY**) rises above the alarm threshold for more than one (1) minute. The air dryer will go into **SHUTDOWN** mode to prevent saturated air from being delivered to the supply line. (Default setting is 10%)

This screen will be displayed, showing the Date and Time that the alarm occurred.

```

SHUTDOWN
HIGH SYS 1 HUMIDITY
01/14/2019 05:08
●INFO
  
```

8.5.2.1 Press the Info (●) Button to see the detail of the alarm.

```

SYSTEM 1 : SHUTDOWN
HUMIDITY- 10.2% ALR
DUTY CYCLE- 29%
←→SEL ↑SETUP ●HOLD
  
```

See section 13.10 for troubleshooting information.

8.5.3 Low Outlet Pressure Alarm –

Occurs when the Outlet Pressure (**OUTLET**) drops below the alarm threshold for more than one (1) minute. (Default setting is 0.30 PSI/2.0KPa)

This screen will be displayed, showing the Date and Time that the alarm occurred.

```

ALARM
LOW OUTLET
01/14/2019 05:08
●INFO
  
```

8.5.3.1 Press the Info (●) Button to see the detail of the alarm.

```

OUTLET- 5.8 PSI LALR
FLOW- 2500 SCFD
TANK- 32.6 PSI
←→SEL ↑SETUP ●HOLD
  
```

See section 13.7 for troubleshooting information.

8.5.4 High Outlet Pressure Alarm -

Occurs when the Outlet Pressure (**OUTLET**) rises above the alarm threshold for more than one (1) minute. (Default setting is 20.00 PSI/138 KPa)

This screen will be displayed, showing the Date and Time that the alarm occurred.

```

ALARM
HIGH OUTLET
01/14/2019 05:08
●INFO
  
```

8.5.4.1 Press the Info (●) Button to see the detail of the alarm.

```

OUTLET-12.2 PSI HALR
FLOW- 2500 SCFD
TANK- 32.6 PSI
←→SEL ↑SETUP ●HOLD
  
```

See section 13.5 for troubleshooting information.

8.5.5 High Flow Rate Alarm –

Occurs when the Flow Rate (**FLOW**) rises above the alarm threshold for more than one (1) minute. (Default setting is 2600 SCFD)

This screen will be displayed, showing the Date and Time that the alarm occurred.

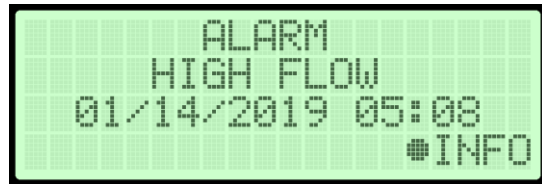

8.5.5.1 Press the Info (●) Button to see the detail of the alarm.

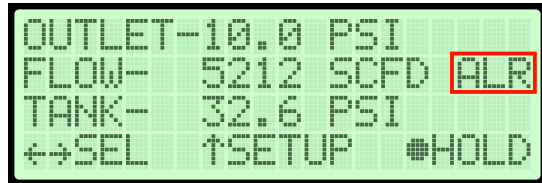

See section 13.9 for troubleshooting information.

8.5.6 Compressor Last Run Time Alarm –

Occurs when the Compressor Last Run Time (**LAST**) exceeds the alarm threshold during the Air Tank pressurization cycle.

(Default setting is 4:00 minutes)

This screen will be displayed, showing the Date and Time that the alarm occurred.



8.5.6.1 Press the Info (●) Button to see the detail of the alarm.

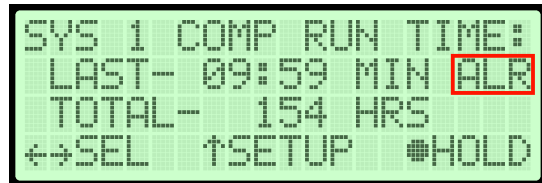

See section 13.1 for troubleshooting information.

8.5.7 Compressor Total Run Time Alarm –

Occurs when the Compressor has reached an 8,000 Hour maintenance interval. Perform the required maintenance.

This screen will be displayed, showing the Date and Time that the alarm occurred.

```

ALARM
COMP 1 TOTAL RUNTIME
01/14/2019 05:08
#INFO
  
```

8.5.7.1 Press the Info (●) Button to see the detail of the alarm.

```

SYS 1 COMP RUN TIME:
LAST- 09:59 MIN
TOTAL- 8002 HRS ALR
←→SEL ↑SETUP #HOLD
  
```

See section 10.3 for maintenance information.

8.6 Accessing the Setup Menu

The P4200W has three (3) Setup sections:

- **System Setup** – Used to set specific values for the system.
- **Alarm Setup**– Used to set the alarm thresholds for specific readings. Once the threshold is reached (or exceeded) this results in an alarm. Each of these thresholds is factory programmed with a default value. Many of can be modified to levels based upon your specific application.
- **Network Setup** – Used to configure network settings including the IP Address, Subnet Mask, Gateway Address, and Keyword.

NOTE: Reference Appendix Section 14.2 for Limits, Defaults, and Formats.

8.6.1 Press the Up (↑) Arrow Button to access the Setup Menu.

```

SYSTEM 1 : ONLINE
HUMIDITY- 1.9%
DUTY CYCLE- 29%
←→SEL ↑SETUP #HOLD
  
```

- 8.6.2** Press the Up (↑) & Down (↓) Arrow Buttons to Select the required menu option.

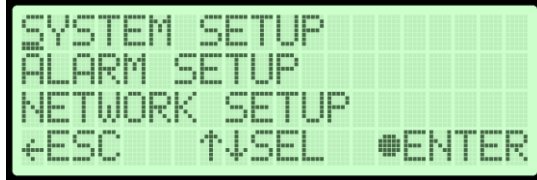

- 8.6.3** Press the Enter (●) Button to access the menu selected or press the Left (←) Arrow Button to Escape to the information screens.

8.7 Using the System Setup Menu

In the Setup Menu:

- 8.7.1** Press the Up (↑) & Down (↓) Arrow Buttons to Select the “S” in System Setup.

- 8.7.2** Press the Enter (●) Button to access System Setup.

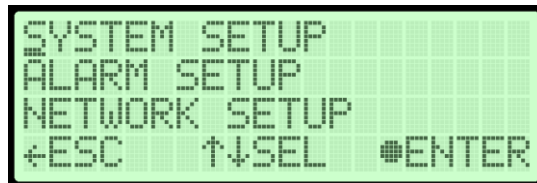

- 8.7.3 Set Alarm Delay** (default setting is ON) –

- 8.7.3.1** Press the Enter (●) Button to access the edit screen.

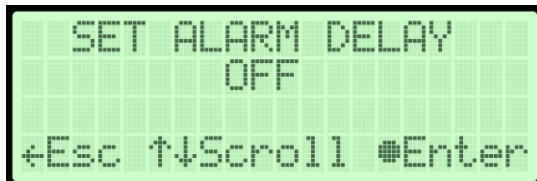

- 8.7.3.2** Press the Up & Down Arrow Buttons to Select the correct choice (On or Off).

- 8.7.3.3** Press the Enter (●) Button to submit the selection.

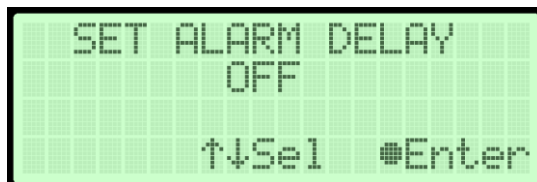

8.7.3.4 Press the Left (←) & Right (→) Arrow Buttons to Select the correct confirmation choice (Yes or No).

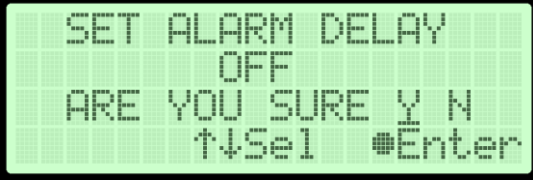

```

SET ALARM DELAY
      OFF
ARE YOU SURE Y N
      ↑↓Sel  ●Enter
  
```

8.7.3.5 Press the Enter (●) Button to confirm the selected choice. This will lock in the new setting.

8.7.4 Press the Up (↑) Arrow Button to access the next screen.

8.7.5 Set Start Up Delay (default setting is 0 seconds) –

8.7.5.1 Press the Enter (●) Button to access the edit screen.



```

SET STARTUP DELAY
      00 SECONDS
(DEFAULT= 0 SECONDS)
←Esc ↑↓Scroll ●Enter
  
```

8.7.5.2 Press the Up & Down Arrow Buttons to Select the digit to change.

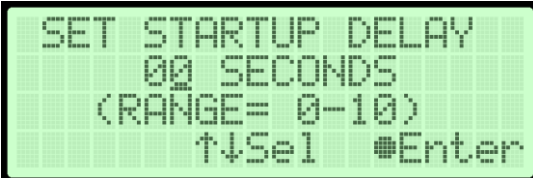

```

SET STARTUP DELAY
      00 SECONDS
(RANGE= 0-10)
      ↑↓Sel  ●Enter
  
```

8.7.5.3 Press the Up (↑) & Down (↓) Arrow Buttons to Change the value of the selected digit.

8.7.5.4 Press the Enter (●) Button to submit the new setting.

8.7.5.5 Press the Left (←) & Right (→) Arrow Buttons to Select the correct confirmation choice (Yes or No).



```

SET STARTUP DELAY
      00 SECONDS
ARE YOU SURE Y N
      ↑↓Chg  ●Enter
  
```

8.7.5.6 Press the Enter (●) Button to confirm the selected choice. This will lock in the new setting.

8.7.6 Press the Up (↑) Arrow Button to access the next screen.

8.7.7 Reset Compressor Total Time –

8.7.7.1 Press the Enter (●) Button to access the reset screen.

```

RESET SYS 1 COMP
TOTAL TIME- 3256 HRS
←Esc ↑↓Scroll ●Enter
  
```

8.7.7.2 Press the Left (←) & Right (→) Arrow Buttons to Select the correct confirmation choice (Yes or No).

```

RESET SYS 1 COMP
TOTAL TIME TO 0 HRS
ARE YOU SURE Y N
●Enter
  
```

8.7.7.3 Press the Enter (●) Button to confirm the selected choice. This will reset the Total Time to zero (0).

8.7.8 Press the Up (↑) Arrow Button to access the next screen.

8.7.9 Reset to Factory Default Values –

8.7.9.1 Press the Enter (●) Button to access the reset screen.

```

RESET TO FACTORY
DEFAULT VALUES
←Esc ↑↓Scroll ●Enter
  
```

8.7.9.2 Press the Left (←) & Right (→) Arrow Buttons to Select the correct confirmation choice (Yes or No).

```

RESET TO FACTORY
DEFAULT VALUES
ARE YOU SURE Y N
●Enter
  
```

8.7.9.3 Press the Enter (●) Button to confirm the selected choice. This will reset all settings to Factory Default Values (section 14.2).

8.7.10 Press the Up (↑) Arrow Button to access the next screen.

8.7.11 Set Date –

8.7.11.1 Press the Enter (●) Button to access the edit screen.

SET CURRENT DATE
01/14/2019
←Esc ↑↓Scroll ●Enter

8.7.11.2 Press the Left (←) & Right (→) Arrow Buttons to Select the digit to change.

SET CURRENT DATE
01/14/2019
Sel←→ Chg↑↓ ●Enter

8.7.11.3 Press the Up (↑) & Down (↓) Arrow Buttons to Change the value of the selected digit.

8.7.11.4 Press the Enter (●) Button to submit the new setting.

8.7.11.5 Press the Left (←) & Right (→) Arrow Buttons to Select the correct confirmation choice (Yes or No).

SET CURRENT DATE
01/14/2019
ARE YOU SURE Y N
Sel←→ Chg↑↓ ●Enter

8.7.11.6 Press the Enter (●) Button to confirm the selected choice. This will lock in the new setting.

8.7.12 Set Time –

8.7.12.1 Press the Enter (●) Button to access the edit screen.

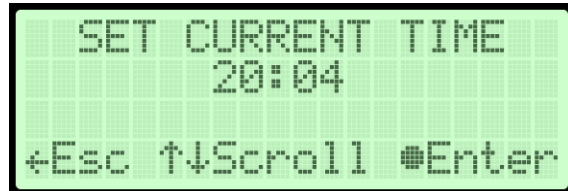

```

SET CURRENT TIME
  20:04
←Esc ↑↓Scroll ●Enter

```

8.7.12.2 Press the Left (←) & Right (→) Arrow Buttons to Select the digit to change.

8.7.12.3 Press the Up (↑) & Down (↓) Arrow Buttons to Change the value of the selected digit.

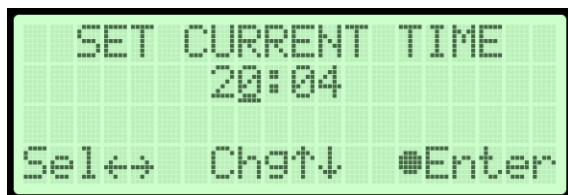

```

SET CURRENT TIME
  20:04
Sel←→ Chg↑↓ ●Enter

```

8.7.12.4 Press the Enter (●) Button to submit the new setting.

8.7.12.5 Press the Left (←) & Right (→) Arrow Buttons to Select the correct confirmation choice (Yes or No).

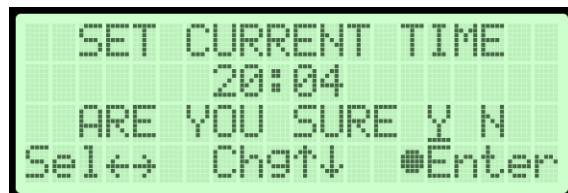

```

SET CURRENT TIME
  20:04
ARE YOU SURE Y N
Sel←→ Chg↑↓ ●Enter

```

8.7.12.6 Press the Enter (●) Button to confirm the selected choice. This will lock in the new setting.

8.7.1 Firmware Update –

8.7.1.1 Insert a USB drive containing an appropriate “.pgz” firmware file from Altec Air into the

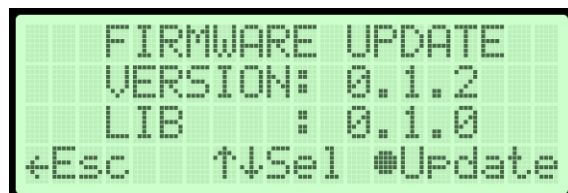

```

FIRMWARE UPDATE
VERSION: 0.1.2
LIB : 0.1.0
←Esc ↑↓Sel ●Update

```

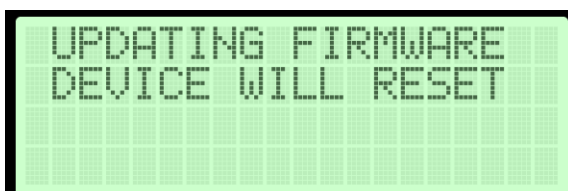

```

UPDATING FIRMWARE
DEVICE WILL RESET

```

USB A port on the control board.

- 8.7.1.2 Press the Enter (●) Button to access the Firmware Update Screen.
- 8.7.1.3 Enter the device keyword and press the Enter (●) Button to access the firmware update screen.
- 8.7.1.4 Select the correct file version using the Up (↑) and Down (↓) Buttons
- 8.7.1.5 Press the Enter (●) button to select the file
- 8.7.1.6 Press the Left (←) & Right (→) Arrow Buttons to Select the correct confirmation choice (Yes or No) and begin the update.

8.7.2 System Units–

- 8.7.2.1 Press the Enter (●) Button to access the edit screen.

- 8.7.2.2 Press the Up (↑) and Down (↓) Arrow Buttons to Change the value.

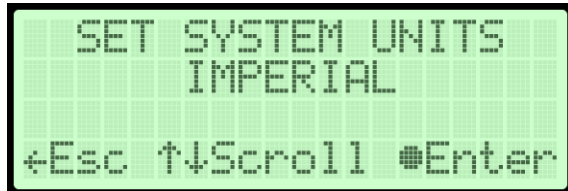

- 8.7.2.3 Press the Enter (●) Button to submit the new setting.

- 8.7.2.4 Press the Left (←) & Right (→) Arrow Buttons to Select the correct confirmation choice (Yes or No).

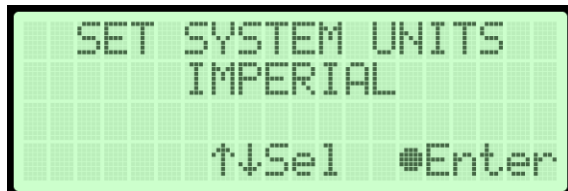

- 8.7.2.5 Press the Enter (●) Button to confirm the selected choice. This will lock in the new setting.

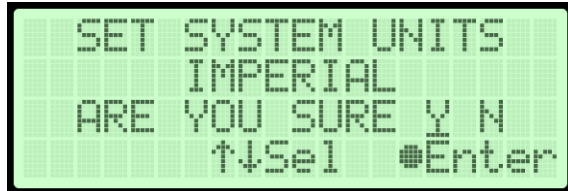

8.7.3 Disable Shutdown

8.7.3.1 Disabling shutdown prevents the device from shutting down the compressors when a high humidity or high temperature alarm is detected. **Altec Air is not responsible for any damage caused by disabling shutdown.**

8.7.3.2 Press the Enter (●) Button to access the edit screen.

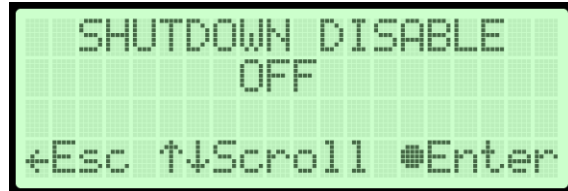

8.7.3.3 Select the option of your choice

8.7.3.4 If disabling shutdown, read the warning and select whether you would like to proceed or not.

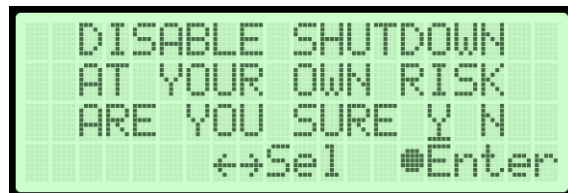

8.8 Using the Alarm Setup Menu

In the Setup Menu:

8.8.1 Press the Up (↑) & Down (↓) Arrow Buttons to Select the "A" in Alarm Setup.

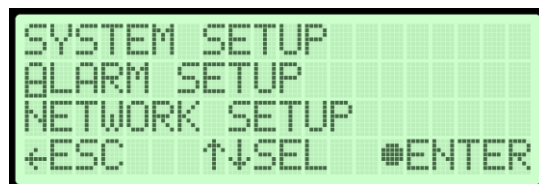

8.8.2 Press the Enter (●) Button to access Alarm Setup.

8.8.3 Set High Humidity Threshold (default setting is 10%) –

8.8.3.1 Press the Enter (●)

Button to access the edit screen.

```

SET HIGH HUMIDITY
THRESHOLD- 5.0%
(DEFAULT= 10.0%)
←Esc ↑↓Scroll ●Enter
  
```

8.8.3.2 Press the Left (←) &

Right (→) Arrow Buttons to select the digit to change.

```

SET HIGH HUMIDITY
THRESHOLD- 10.0%
(RANGE= 3.0-15.0)
↔SEL ↑↓CHG ●ENTER
  
```

8.8.3.3 Press the Up (↑) & Down (↓) Arrow Buttons to Change the value of the selected digit.

8.8.3.4 Press the Enter (●) Button when to submit the new setting.

8.8.3.5 Press the Left (←) & Right (→) Arrow Buttons to Select the correct confirmation choice (Yes or No).

```

SET HIGH HUMIDITY
THRESHOLD- 10.0%
ARE YOU SURE Y N
SEL↔ ↑↓Chg ●ENTER
  
```

8.8.3.6 Press the Enter (●) Button to confirm the selected choice. This will lock in the new setting.

8.8.4 Press the Up (↑) Arrow Button to access the next screen.

8.8.5 Set High Outlet Threshold (default setting is 20.00 PSI/138 KPa) –

8.8.5.1 Press the Enter (●)

Button to access the edit screen.

```

SET HIGH OUTLET
THRESHOLD- 10.5 PSI
(DEFAULT= 20.0 PSI)
←ESC ↑↓SCROLL ●ENTER
  
```

8.8.5.2 Press the Left (←) &

Right (→) Arrow Buttons to Select the digit to change.

```

SET HIGH OUTLET
THRESHOLD- 10.5 PSI
(RANGE= 0.4-20.4)
↔Sel ↑↓Chg ●Enter
  
```

8.8.5.3 Press the Up (↑) & Down (↓) Arrow Buttons to Change the value of the selected digit.

8.8.5.4 Press the Enter (●) Button when to submit the new setting.

```

SET HIGH OUTLET
THRESHOLD- 10.5 PSI
ARE YOU SURE Y N
←→Sel  ↑↓Chg  ●Enter
  
```

8.8.5.5 Press the Left (←) & Right (→) Arrow Buttons to Select the correct confirmation choice (Yes or No).

8.8.5.6 Press the Enter (●) Button to confirm the selected choice. This will lock in the new setting.

8.8.6 Press the Up (↑) Arrow Button to access the next screen.

8.8.7 Set Low Pressure Threshold
(default setting is 0.30 PSI/2.0 KPa) –

```

SET LOW OUTLET
THRESHOLD- 0.2 PSI
(DEFAULT= 0.3 PSI)
←Esc ↑↓Scroll ●Enter
  
```

8.8.7.1 Press the Enter (●) Button to access the edit screen.

```

SET LOW OUTLET
THRESHOLD- 0.3 PSI
(RANGE= 0.3-19.9)
←→SEL  ↑↓CHG  ●ENTER
  
```

8.8.7.2 Press the Left (←) & Right (→) Arrow Buttons to Select the digit to change.

```

SET LOW OUTLET
THRESHOLD- 0.3 PSI
(RANGE= 0.3-19.9)
←→SEL  ↑↓CHG  ●ENTER
  
```

8.8.7.3 Press the Up (↑) & Down (↓) Arrow Buttons to Change the value of the selected digit.

8.8.7.4 Press the Enter (●) Button when to submit the new setting.

8.8.7.5 Press the Left (←) & Right (→) Arrow Buttons to Select the correct confirmation choice (Yes or No).

SET LOW OUTLET
THRESHOLD- 0.3 PSI
ARE YOU SURE Y N
SEL ← → ↑ ↓ CHG # ENTER

8.8.7.6 Press the Enter (●) Button to confirm the selected choice. This will lock in the new setting.

8.8.8 Press the Up (↑) Arrow Button to access the next screen.

8.8.9 Set High Flow Threshold (default setting is 2600 SCFD)

8.8.9.1 Press the Enter (●) Button to access the edit screen.

SET HIGH FLOW
THRESHOLD- 2600 SCFD
(DEFAULT= 2600 SCFD)
←ESC ↑↓SCROLL #ENTER

8.8.9.2 Press the Left (←) & Right (→) Arrow Buttons to Select the digit to change.

SET HIGH FLOW
THRESHOLD- 2600 SCFD
(RANGE= 0-4200)
←→SEL ↑↓CHG #ENTER

8.8.9.3 Press the Up (↑) & Down (↓) Arrow Buttons to Change the value of the selected digit.

8.8.9.4 Press the Enter (●) Button when to submit the new setting.

8.8.9.5 Press the Left (←) & Right (→) Arrow Buttons to Select the correct confirmation choice (Yes or No).

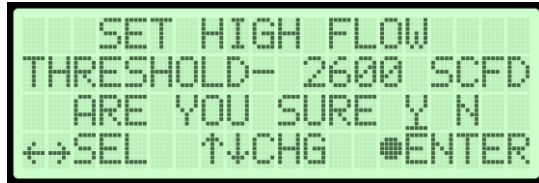

```

SET HIGH FLOW
THRESHOLD- 2600 SCFD
ARE YOU SURE Y N
←→SEL ↑↓CHG #ENTER
  
```

8.8.9.6 Press the Enter (●) Button to confirm the selected choice. This will lock in the new setting.

8.8.10 Press the Up (↑) Arrow Button to access the next screen.

8.8.11 Set Duty Cycle Threshold (default setting is 70%)

8.8.11.1 Press the Enter (●) Button to access the edit screen.



```

SET HIGH DUTY CYCLE
THRESHOLD- 65 %
(DEFAULT= 70 %)
←Esc ↑↓Scroll #Enter
  
```

8.8.11.2 Press the Left (←) & Right (→) Arrow Buttons to Select the digit to change.

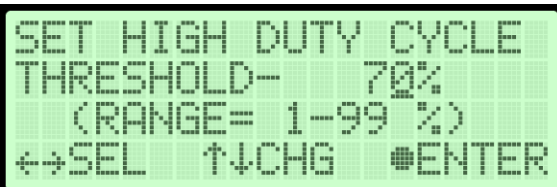

```

SET HIGH DUTY CYCLE
THRESHOLD- 70%
(RANGE= 1-99 %)
←→SEL ↑↓CHG #ENTER
  
```

8.8.11.3 Press the Up (↑) & Down (↓) Arrow Buttons to Change the value of the selected digit.

8.8.11.4 Press the Enter (●) Button when to submit the new setting.

8.8.11.5 Press the Left (←) & Right (→) Arrow Buttons to Select the correct confirmation choice (Yes or No).

SET HIGH DUTY CYCLE
THRESHOLD- 70%
ARE YOU SURE Y N
SEL←→ ↑↓Chg #ENTER

8.8.11.6 Press the Enter (●) Button to confirm the selected choice. This will lock in the new setting.

8.8.12 Set Compressor Last Run Threshold (default setting is 4:00 min)

8.8.12.1 Press the Enter (●) Button to access the edit screen.

SET COMP LAST RUN
THRESHOLD- 04:00 MIN
(DEFAULT= 04:00 MIN)
←ESC ↑↓SCROLL #ENTER

8.8.12.2 Press the Left (←) & Right (→) Arrow Buttons to Select the digit to change.

SET COMP LAST RUN
THRESHOLD- 04:00 MIN
(RANGE= 00:00-04:00)
Sel←→ Chg↑↓ #Enter

8.8.12.3 Press the Up (↑) & Down (↓) Arrow Buttons to Change the value of the selected digit.

8.8.12.4 Press the Enter (●) Button when to submit the new setting.

8.8.12.5 Press the Left (←) & Right (→) Arrow Buttons to Select the correct confirmation choice (Yes or No).

SET HIGH FLOW
THRESHOLD- 2600 SCFD
ARE YOU SURE Y N
←→SEL ↑↓CHG #ENTER

8.8.12.6 Press the Enter (●) Button to confirm the selected choice. This will lock in the new setting.

8.8.13 Press the Up (↑) Arrow Button to access the next screen.

8.9 Using the Network Setup Menu

In the Setup Menu:

8.9.1 Press the Up (↑) & Down (↓) Arrow Buttons to Select the “N” in Network Setup.

8.9.1.1 Press the Enter (●) Button to access Network Setup.

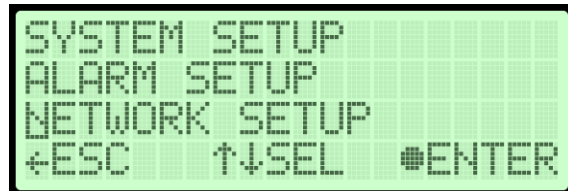

8.9.2 Enter Keyword (default Keyword is 123456) –

8.9.2.1 Press the Left (←) & Right (→) Arrow Buttons to Select the digit to change.

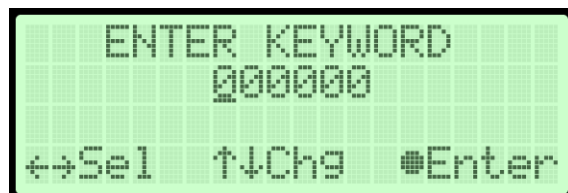

8.9.2.2 Press the Up (↑) & Down (↓) Arrow Buttons to Change the value of the selected digit.

8.9.2.3 Press the Enter (●) Button to submit the Keyword.

8.9.3 Set IP Address (default is 192.168.1.100) –

- 8.9.3.1** Press the Enter (●) Button to access the edit screen.

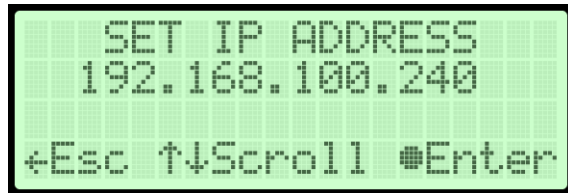

- 8.9.3.2** Press the Left (←) & Right (→) Arrow Buttons to Select the digit to change.

- 8.9.3.3** Press the Up (↑) & Down (↓) Arrow Buttons to Change the value of the selected digit.



- 8.9.3.4** Press the Enter (●) Button when to submit the new setting.

- 8.9.3.5** Press the Left (←) & Right (→) Arrow Buttons to Select the correct confirmation choice (Yes or No).

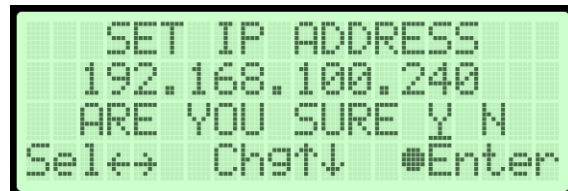

- 8.9.3.6** Press the Enter (●) Button to confirm the selected choice. This will lock in the new setting.

8.9.4 Set Subnet Mask (default is 255.255.255.000) –

- 8.9.4.1** Press the Enter (●) Button to access the edit screen.

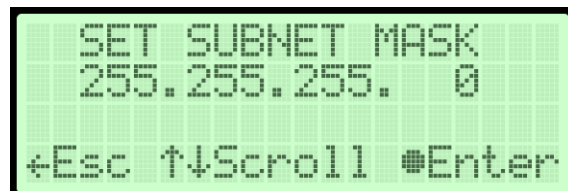

8.9.4.2 Press the Left (←) & Right (→) Arrow Buttons to Select the digit to change.

8.9.4.3 Press the Up (↑) & Down (↓) Arrow Buttons to Change the value of the selected digit.

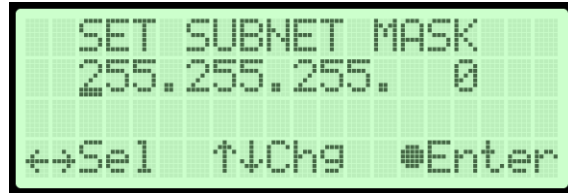

```

SET SUBNET MASK
255.255.255. 0
←Sel  ↑↓Chg  ●Enter
  
```

8.9.4.4 Press the Enter (●) Button when to submit the new setting.

8.9.4.5 Press the Left (←) & Right (→) Arrow Buttons to Select the correct confirmation choice (Yes or No).

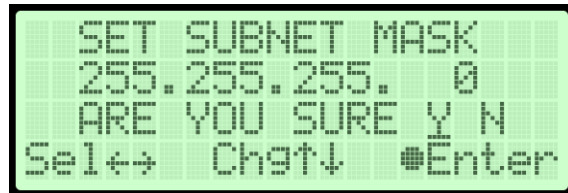

```

SET SUBNET MASK
255.255.255. 0
ARE YOU SURE Y N
Sel←  Chg↑↓  ●Enter
  
```

8.9.4.6 Press the Enter (●) Button to confirm the selected choice. This will lock in the new setting.

8.9.5 Set Gateway Address (default is 000.000.000.000) –

8.9.5.1 Press the Enter (●) Button to access the edit screen.

8.9.5.2 Press the Left (←) & Right (→) Arrow Buttons to Select the digit to change.

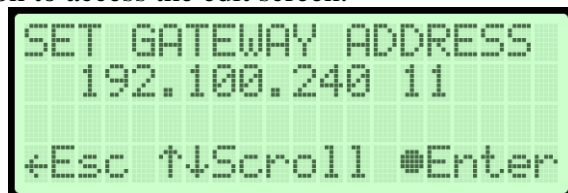

```

SET GATEWAY ADDRESS
192.100.240 11
←Esc  ↑↓Scroll  ●Enter
  
```

8.9.5.3 Press the Up (↑) & Down (↓) Arrow Buttons to Change the value of the selected digit.

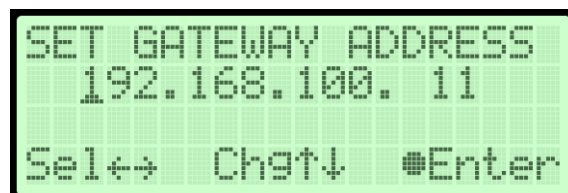

```

SET GATEWAY ADDRESS
192.168.100. 11
Sel←  Chg↑↓  ●Enter
  
```

8.9.5.4 Press the Enter (●) Button when to submit the new setting.

8.9.5.5 Press the Left (←) & Right (→) Arrow Buttons to Select the correct confirmation choice (Yes or No).

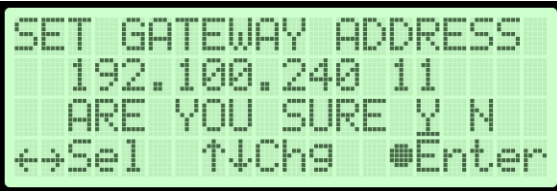

```

SET GATEWAY ADDRESS
192.100.240 11
ARE YOU SURE Y N
←→Sel ↑↓Chg ●Enter
  
```

8.9.5.6 Press the Enter (●) Button to confirm the selected choice. This will lock in the new setting.

8.9.6 Set SNMP Trap Server (default is 000.000.000.000) –

8.9.6.1 Press the Enter (●) Button to access the edit screen.

8.9.6.2 Press the Left (←) & Right (→) Arrow Buttons to Select the digit to change.

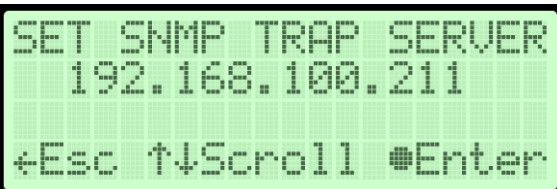

```

SET SNMP TRAP SERVER
192.168.100.211
←Esc ↑↓Scroll ●Enter
  
```

8.9.6.3 Press the Up (↑) & Down (↓) Arrow Buttons to Change the value of the selected digit.

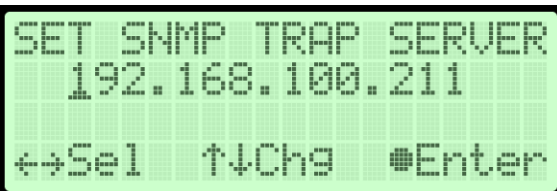

```

SET SNMP TRAP SERVER
192.168.100.211
←→Sel ↑↓Chg ●Enter
  
```

8.9.6.4 Press the Enter (●) Button when to submit the new setting.

8.9.6.5 Press the Left (←) & Right (→) Arrow Buttons to Select the correct confirmation choice (Yes or No).

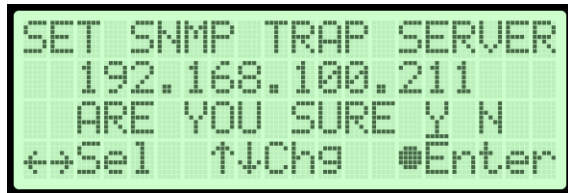

```

SET SNMP TRAP SERVER
 192.168.100.211
 ARE YOU SURE Y N
←Sel ↑Chg #Enter

```

8.9.6.6 Press the Enter (●) Button to confirm the selected choice. This will lock in the new setting.

8.9.7 Change Keyword (default is 123456) –

8.9.7.1 Press the Enter (●) Button to access the edit screen.

8.9.7.2 Press the Left (←) & Right (→) Arrow Buttons to Select the digit to change.

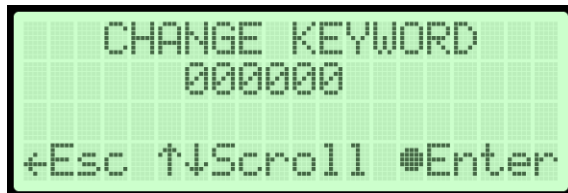

```

CHANGE KEYWORD
 000000
←Esc ↑Scroll #Enter

```

8.9.7.3 Press the Up (↑) & Down (↓) Arrow Buttons to Change the value of the selected digit.

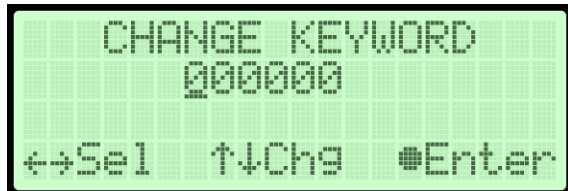

```

CHANGE KEYWORD
 000000
←Sel ↑Chg #Enter

```

8.9.7.4 Press the Enter (●) Button when to submit the new setting.

8.9.7.5 Press the Left (←) & Right (→) Arrow Buttons to Select the correct confirmation choice (Yes or No).

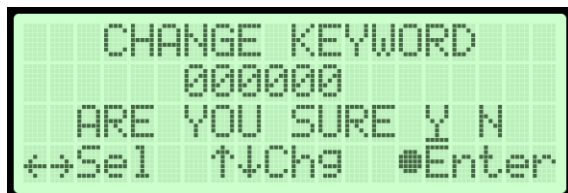

```

CHANGE KEYWORD
 000000
 ARE YOU SURE Y N
←Sel ↑Chg #Enter

```

8.9.7.6 Press the Enter (●) Button to confirm the selected choice. This will lock in the new settings

8.9.8 Set Monitoring System Address (default is 0) –

8.9.8.1 Press the Enter (●) Button to access the edit screen.

8.9.8.2 Press the Up (↑) & Down (↓) Arrow Buttons to Change the value

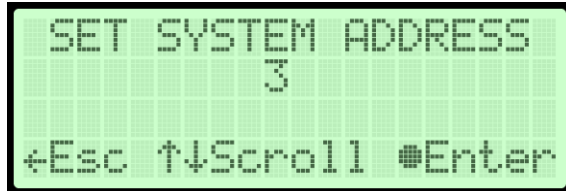

```

SET SYSTEM ADDRESS
  3
←ESC ↑↓Scroll ●Enter
  
```

8.9.8.3 Press the Enter (●) Button when to submit the new setting.

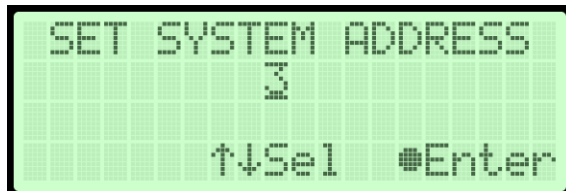

```

SET SYSTEM ADDRESS
  3
      ↑↓Sel  ●Enter
  
```

8.9.8.4 Press the Left (←) & Right (→) Arrow Buttons to Select the correct confirmation choice (Yes or No).

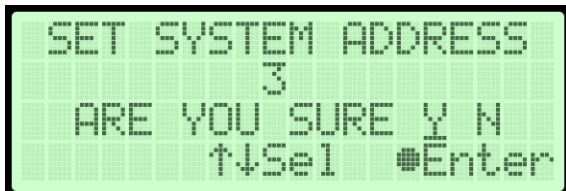

```

SET SYSTEM ADDRESS
  3
ARE YOU SURE Y N
      ↑↓Sel  ●Enter
  
```

8.9.8.5 Press the Enter (●) Button to confirm the selected choice. This will lock in the new setting.

8.9.9 View MAC address

8.9.9.1 The device MAC address can be viewed from the network setup menu



```

MAC ADDRESS
00:0A:95:9D:68:16
←ESC  ↑↓SEL
  
```

8.10 Removing the Front Panel

8.10.1 Depress the four (4) Locking Latches.

8.10.2 Pull the Front Panel away from the dryer.

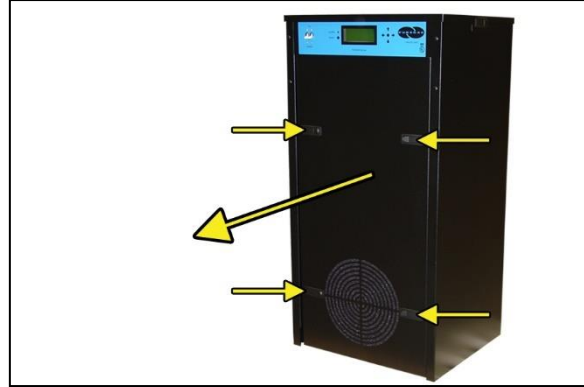

8.11 Removing the Top Cover

8.11.1 Use the included Latch Keys to unlock the two (2) Locking Latches.

8.11.2 Depress the two (2) Locking Latches.

8.11.3 Lift the Top Cover off of the dryer.



NOTE: There is a wire connected between the Top Cover and the dryer's main frame. This is used for grounding purposes.

8.12 Depressurizing the Dryer

8.12.1 Remove the Front Panel (section 8.10).

8.12.2 Pull the ring handle on the Safety Relief Valve until all air pressure is released.

NOTE: To prevent pressure from building back up, power the dryer **OFF** (section 8.3).

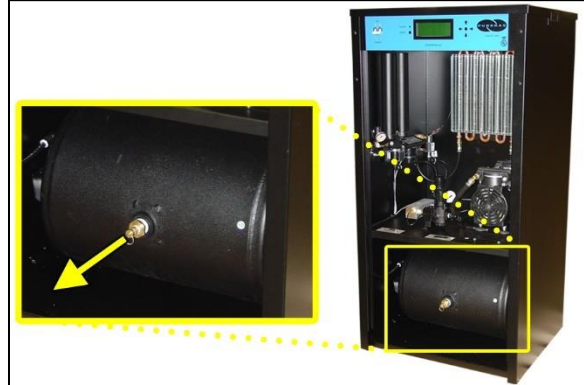

8.12.3 Reinstall the Front Panel (section 8.10).

8.13 Connecting to Common Alarm Ports

8.13.1 Locate the common alarm port labelled 0 and 1 on the control board.

8.13.2 You may use either for the following functionality

- **Wire to Common** and **N.C.** for OPEN ON ALARM operation.
- **Wire to Common** and **N.O.** for CLOSE ON ALARM operation.

8.14 Setting the System Pressure

8.14.1 Remove the Front Panel (section 8.10).

With Compressor running:

8.14.2 Pull the Capacity Control Valve knob out.

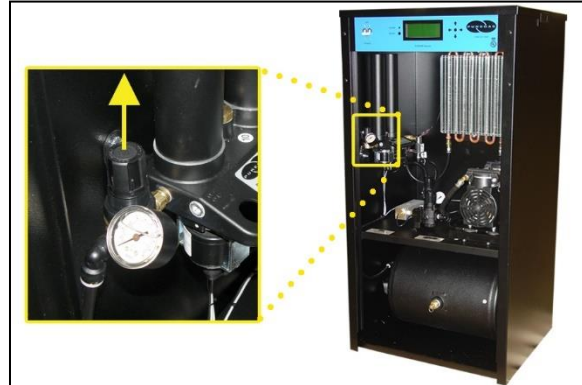

8.14.3 Turn the knob until the reading on the Pressure Gauge is **50 PSI/345 KPa**.

8.14.4 Push the knob in to lock.



8.14.5 Reinstall the Front Panel (section 8.10).

8.15 Setting the Static Pressure

8.15.1 Remove the Front Panel (section 8.10).

8.15.2 Pull the Static Pressure Regulator knob out.

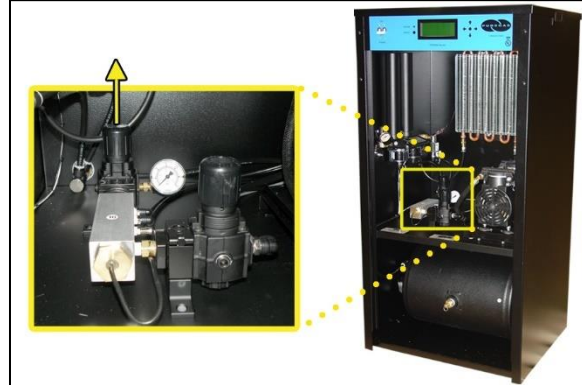

8.15.3 Turn knob until the reading on the Pressure Gauge is **20 PSI/138 KPa**.

8.15.4 Push knob in to lock.

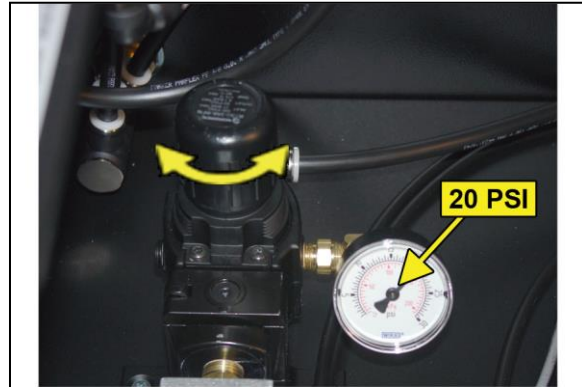

8.15.5 Reinstall the Front Panel (section 8.10).

8.16 Setting the Outlet Pressure

8.16.1 Remove the Front Panel (section 8.10).

8.16.2 Pull the Outlet Pressure Regulator knob out.

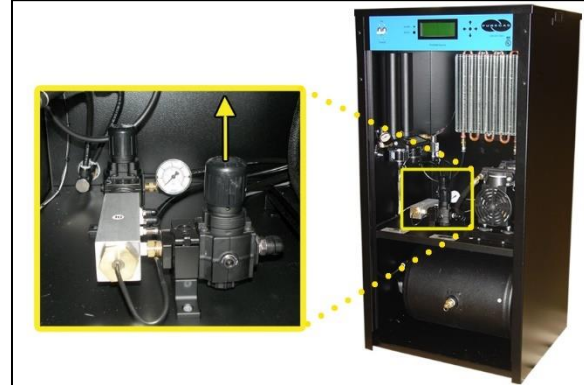

8.16.3 Turn knob until Outlet Pressure (**OUTLET**) reading is at the desired setting.



8.16.4 Push knob in to lock.

8.16.5 Reinstall the Front Panel (section 8.10).

8.17 Connecting via Web Browser

If the Air Dryer IS connected to an IP network:

- The Air Dryer must be configured with a valid IP Address, Subnet Mask, and Gateway Address for the network.
- An IP cable must be connecting the air dryer to the network.
- Use a computer that is on the same network as the air dryer.
- Use Internet Explorer (6.0 or newer) or Mozilla Firefox Web Browser.

If the Air Dryer IS NOT connected to an IP network and has not been configured with IP information:

- Use the default IP Address (*192.168.1.102*) of the air dryer to connect.
- Use an IP Cable (may require Cross-over cable) plugged directly into a Laptop/PC and the other end plugged into the Network Port of the air dryer.
- Configure the network card on the Laptop/PC to use the IP Address *192.168.1.101*. This will make the Laptop/PC compatible with the air dryer.
- Use Internet Explorer (6.0 or newer) or Mozilla Firefox Web Browser.

8.17.1 Type the IP Address of the P4200W Series Air Dryer in the Address text box of the Web Browser.

The Web Browser connection offers five (4) screens to the user:

- **Status Screen** - Displays the readings and alarms monitored in the P4200W Series Air Dryer. Provides remote ALARM RESET.
- **Setup Screen** - All configurations for System, Alarms, Network, and Keyword can be made in this screen.
- **Event/Alarm Screen** - Displays all events such as alarms, changes made, and alarm resets registered by the P4200W Series Air Dryer. This screen is informational only.

- **Firmware Screen** – Allows the user to upload any software updates or upgrades to the Air Dryer.

8.17.2 Click on the Menu Bar selection to access a specific screen.

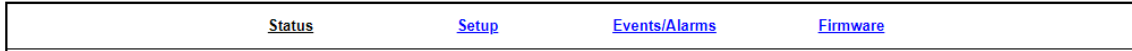

8.18 Using the Status Screen

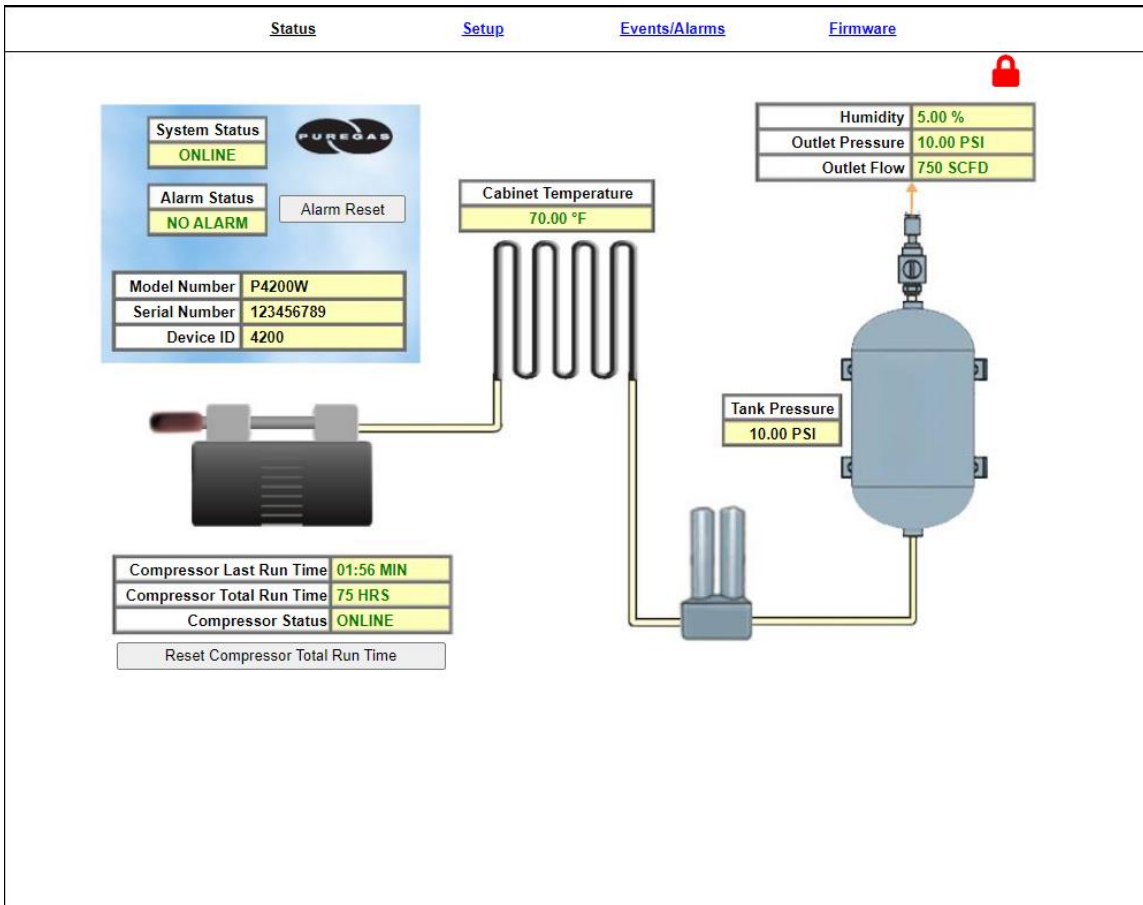

Displays the readings and alarms monitored in the P4200W Series Air Dryer.
Provides remote ALARM RESET.

- Readings are displayed in **BLACK** unless an alarm is present.
- Alarms are displayed in **RED** next to the parameter in alarm.

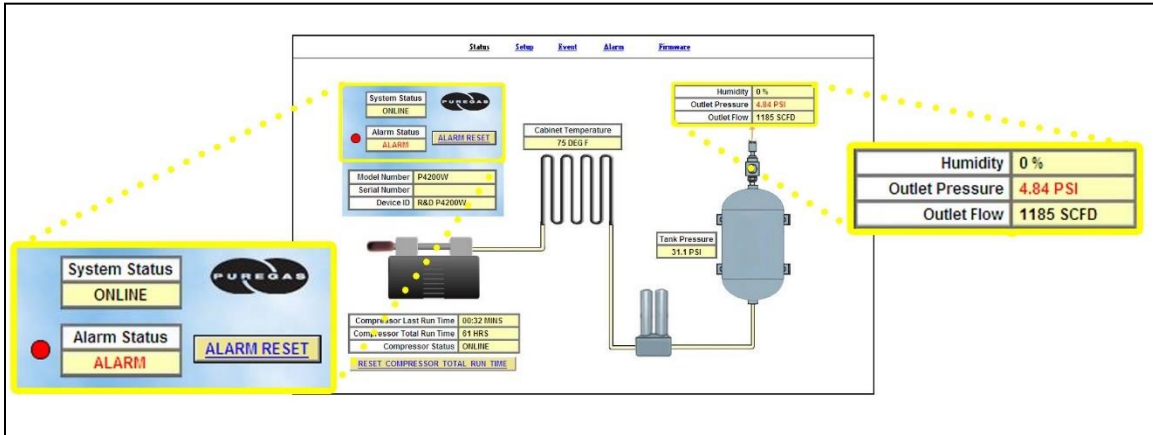

- Alarm Status will display **ALARM** in red if any alarms are present.
- Keyword validation is required for ALARM RESET and RESET COMPRESSOR TOTAL RUN TIME.

8.18.1 Resetting an Alarm

8.18.1.1 Click on the **ALARM RESET** Button to remotely reset Air Dryer alarms displayed on Status Screen.

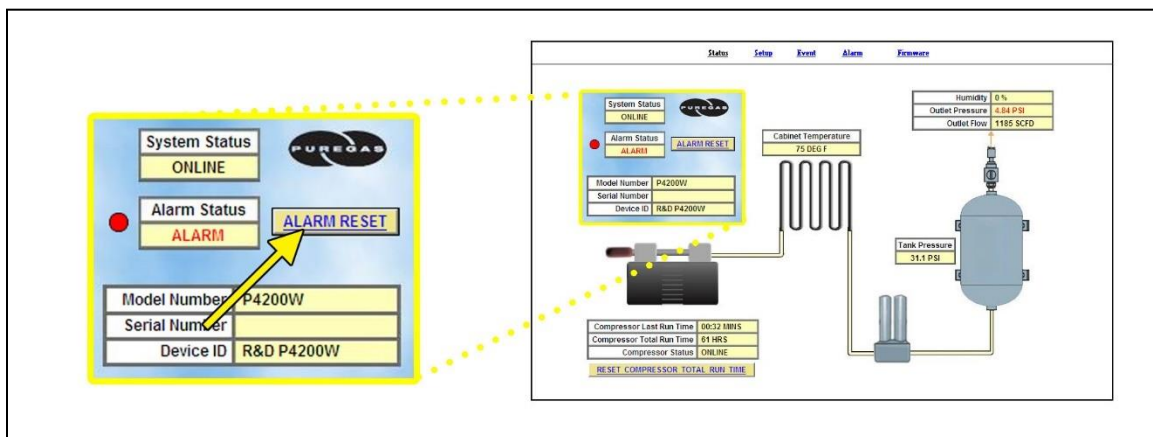

8.18.1.2 Enter Keyword (default is 123456)

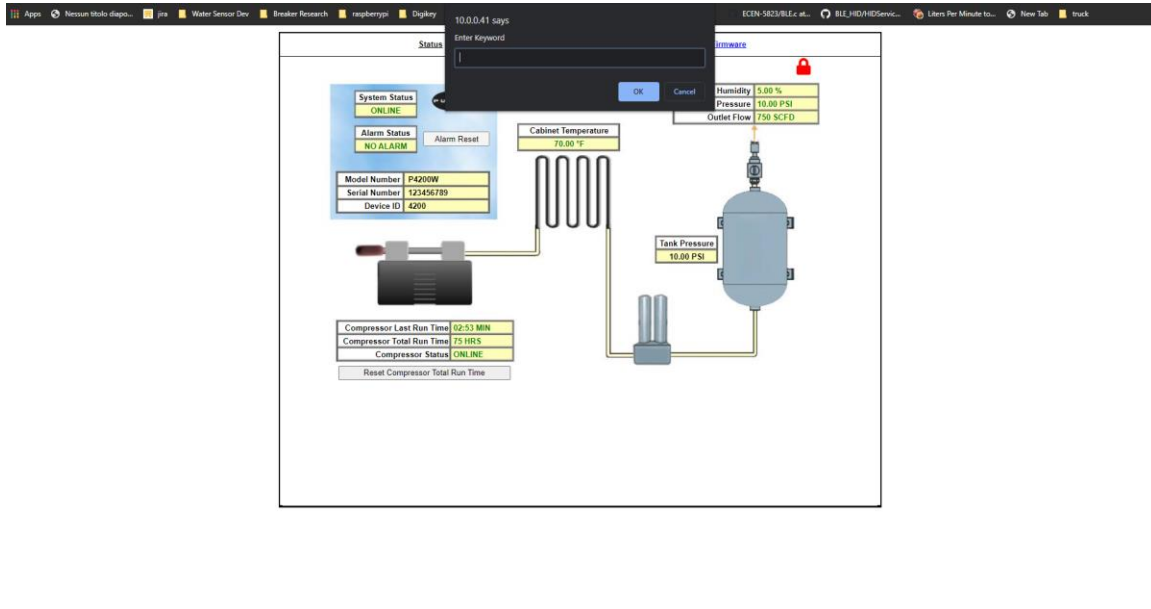

8.18.1.3 Click on **SUBMIT** Button when done.

8.18.2 Resetting Compressor Total Run Time

8.18.2.1 Click on the **RESET COMPRESSOR TOTAL RUN TIME**

Button to remotely reset Compressor Total Run Time displayed on Status Screen.

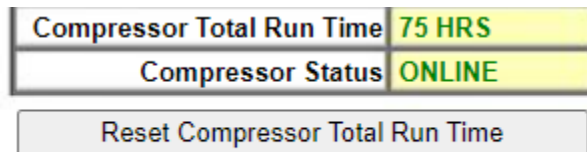

8.18.2.2 Enter Keyword (default is 123456)

8.18.2.3 Click on **SUBMIT** Button when done.

8.19 Using the Setup Screen

All configurations for the System, Alarms, Network, and Keyword can be made in this screen.

Status	Setup	Events/Alarms	Firmware																																			
<p>SYSTEM SETUP </p> <table border="1"> <thead> <tr> <th>Description</th> <th>Setting</th> </tr> </thead> <tbody> <tr> <td>Alarm Delay</td> <td><input checked="" type="radio"/> ON <input type="radio"/> OFF</td> </tr> <tr> <td>Startup Delay</td> <td><input type="text" value="NONE"/></td> </tr> <tr> <td>Units</td> <td><input type="text" value="Imperial"/></td> </tr> <tr> <td>Current Date</td> <td>01/04/2000</td> </tr> <tr> <td>Current Time</td> <td>00:46</td> </tr> <tr> <td>Device ID</td> <td>4200</td> </tr> <tr> <td>Keyword</td> <td>*****</td> </tr> </tbody> </table>				Description	Setting	Alarm Delay	<input checked="" type="radio"/> ON <input type="radio"/> OFF	Startup Delay	<input type="text" value="NONE"/>	Units	<input type="text" value="Imperial"/>	Current Date	01/04/2000	Current Time	00:46	Device ID	4200	Keyword	*****																			
Description	Setting																																					
Alarm Delay	<input checked="" type="radio"/> ON <input type="radio"/> OFF																																					
Startup Delay	<input type="text" value="NONE"/>																																					
Units	<input type="text" value="Imperial"/>																																					
Current Date	01/04/2000																																					
Current Time	00:46																																					
Device ID	4200																																					
Keyword	*****																																					
<p>ALARM SETUP <input type="button" value="Reset All Alarm Settings To Factory Default Values"/></p> <table border="1"> <thead> <tr> <th>Description</th> <th>Default</th> <th>Range</th> <th>Current Setting</th> <th>Unit</th> </tr> </thead> <tbody> <tr> <td>High Outlet Pressure</td> <td>20</td> <td>0.4 - 20</td> <td>20.0</td> <td>PSI</td> </tr> <tr> <td>Low Outlet Pressure</td> <td>0.3</td> <td>0.3 - 19.9</td> <td>0.3</td> <td>PSI</td> </tr> <tr> <td>High Flow</td> <td>4500</td> <td>0 - 6500</td> <td>4200.0</td> <td>SCFD</td> </tr> <tr> <td>High Humidity</td> <td>10.0</td> <td>3.0 - 15.0</td> <td>10.0</td> <td>%</td> </tr> <tr> <td>High Duty Cycle</td> <td>70</td> <td>0 - 99</td> <td>70</td> <td>%</td> </tr> <tr> <td>High Compressor Last Run Time</td> <td>3:00</td> <td>1:00 - 59:59</td> <td>03:00</td> <td>MIN:SEC</td> </tr> </tbody> </table>				Description	Default	Range	Current Setting	Unit	High Outlet Pressure	20	0.4 - 20	20.0	PSI	Low Outlet Pressure	0.3	0.3 - 19.9	0.3	PSI	High Flow	4500	0 - 6500	4200.0	SCFD	High Humidity	10.0	3.0 - 15.0	10.0	%	High Duty Cycle	70	0 - 99	70	%	High Compressor Last Run Time	3:00	1:00 - 59:59	03:00	MIN:SEC
Description	Default	Range	Current Setting	Unit																																		
High Outlet Pressure	20	0.4 - 20	20.0	PSI																																		
Low Outlet Pressure	0.3	0.3 - 19.9	0.3	PSI																																		
High Flow	4500	0 - 6500	4200.0	SCFD																																		
High Humidity	10.0	3.0 - 15.0	10.0	%																																		
High Duty Cycle	70	0 - 99	70	%																																		
High Compressor Last Run Time	3:00	1:00 - 59:59	03:00	MIN:SEC																																		
<p>NETWORK SETUP</p> <table border="1"> <thead> <tr> <th>Description</th> <th>Setting</th> </tr> </thead> <tbody> <tr> <td>IP Address</td> <td>10.0.0.41</td> </tr> <tr> <td>Subnet Mask</td> <td>255.255.255. 0</td> </tr> <tr> <td>Gateway Address</td> <td>10.0.0.1</td> </tr> <tr> <td>SNMP Trap Server Address</td> <td>0. 0. 0. 0</td> </tr> </tbody> </table>				Description	Setting	IP Address	10.0.0.41	Subnet Mask	255.255.255. 0	Gateway Address	10.0.0.1	SNMP Trap Server Address	0. 0. 0. 0																									
Description	Setting																																					
IP Address	10.0.0.41																																					
Subnet Mask	255.255.255. 0																																					
Gateway Address	10.0.0.1																																					
SNMP Trap Server Address	0. 0. 0. 0																																					

- Values in **BLUE** represent the current setting.
- The **ENTER** key is used to change values.
- The **CHANGE KEYWORD** Button allows you to configure a new Keyword.
- Keyword validation is required for the following:
 - Changing a Threshold value
 - Changing the Keyword

8.19.1 Changing a Threshold or Setup value:

8.19.1.1 Click on the value to change.

8.19.1.2 Type in the new value.

8.19.1.3 press the **ENTER** key when done.

8.19.1.4 Enter Keyword (default is 123456)

8.19.1.5 Click on **SUBMIT** Button when done. This will lock in the new setting value.

8.19.2 Changing the Keyword

8.19.2.1 Click on the ********* display in the keyword row to change the keyword.

8.19.2.2 Type the Old Keyword.

8.19.2.3 Type the New Keyword.

8.19.2.4 Type the Confirm New Keyword.

8.19.2.5 Click on **OK** Button to confirm. This will lock in the new setting value.

8.20 Using the Event Screen

Displays all events such as alarms, changes made, and alarm resets registered by the P4200W Series Air Dryer. This screen is informational only.

		Status	Setup	Events/Alarms	Firmware
Event Type	Description				Timestamp 
Alarm	High Compressor 1 Last Runtime				1/4/2000, 12:44:56 AM
Info	Alarms Reset				1/4/2000, 12:44:54 AM
Alarm	High Compressor 1 Last Runtime				1/4/2000, 12:43:21 AM
Parameter Change	Device ID changed from "" to "4200"				1/4/2000, 12:40:41 AM
Info	Alarms Reset				1/4/2000, 12:40:18 AM
Alarm	High Humidity System 1 (System SHUTDOWN)				1/4/2000, 12:37:43 AM
Alarm	Low Outlet Pressure				1/4/2000, 12:37:43 AM
Info	Unit Power On (Firmware: 0.1.9 Library: 0.1.1)				1/4/2000, 12:35:38 AM
Parameter Change	High Flow Threshold Changed From "4500.0 SCFD" to "4200.0 SCFD"				1/1/2000, 2:34:52 AM
Alarm	High Humidity System 1 (System SHUTDOWN)				1/1/2000, 12:09:28 AM
Alarm	Low Outlet Pressure				1/1/2000, 12:09:28 AM
Info	Unit Power On (Firmware: 0.1.9 Library: 0.1.1)				1/1/2000, 12:07:23 AM
Alarm	High Humidity System 1 (System SHUTDOWN)				1/1/2000, 12:28:45 AM
Alarm	Low Outlet Pressure				1/1/2000, 12:28:45 AM
Info	Unit Power On (Firmware: 0.1.7 Library: 0.1.1)				1/1/2000, 12:26:41 AM
Info	Unit Power On (Firmware: 0.1.7 Library: 0.1.1)				1/1/2000, 12:24:13 AM

- Click on the Event Type Header to sort data.

8.21 Using the Firmware Screen

Displays the current firmware version of the P4200W Series Air Dryer.

Status	Setup	Events/Alarms	Firmware
Current Version:	Firmware Version: 0.1.9 Library Version: 0.1.1		
New Version File:	Choose File	No file chosen	
<input type="button" value="ACCEPT"/>			

- **Current Version:** Displays the current firmware version of the P4200W Series Air Dryer.
- **New Version File:** Displays the new location and new firmware version chosen.
- The **BROWSE** Button allows you to locate the new firmware file.
- The **ACCEPT** Button is used to change values.

- Keyword validation is required to update firmware.

8.21.1 Updating the Firmware:

8.21.1.1 Click on **BROWSE** Button to locate the firmware file.

8.21.1.2 Navigate and select the correct .pgz file. Press the **OK** Button.

8.21.1.3 Click the **ENTER** Button.

8.21.1.4 Enter Keyword (default is 123456)

8.21.1.5 Click on **SUBMIT** Button when done. This will lock in the new firmware version.

8.22 Connecting via SNMP

Using SNMP to connect and communicate with the P4200W Series Air Dryer is dependent upon the specific SNMP Management software used on your network. This software requires a SNMP Definition & Configuration File (MIB file) in order to properly communicate with the Air Dryer.

The files for the P4200W Series Air Dryers can be downloaded from our website (AltecAIR.com) under the Product Support section SNMP Files link. It is necessary to import this file into your SNMP operating software.

NOTE: Reference Appendix section 14.3 for a list of SNMP Parameters.

9. Testing Your Dryer

9.1 Safety & Warning Information



WARNING!

Extreme care should be exercised to avoid contact with live electrical circuits. Many procedures performed during installation, operation, testing, and maintenance of this air dryer require the equipment to be running, creating a situation for potential electrical shock. It is highly recommended that you remove all jewelry before performing any procedures.



WARNING!

Internal surfaces may be hot. Use care when coming into contact with internal components as there is a potential for some of these components to become hot when in operation or standby.



WARNING!

High Noise. Altec AIR air dryers are meant to be installed in an unattended area.



CAUTION!

Observe precautions for handling **Electrostatic Sensitive Devices.**



CAUTION!

Depressurizing the air dryer may be necessary before performing certain procedures. **NEVER** remove pressure sensing tubes from the control board without depressurizing the air dryer first, or **damage to the control board will occur.**

9.2 Measuring Compressor Amp Draw



WARNING!

Internal surfaces may be hot. Use care when coming into contact with internal components as there is a potential for some these components to become hot when in operation or standby.

9.2.1 Remove the Front Panel (section 8.10).

With the Compressor running:

9.2.2 Locate the BLACK wire coming directly from the Compressor.

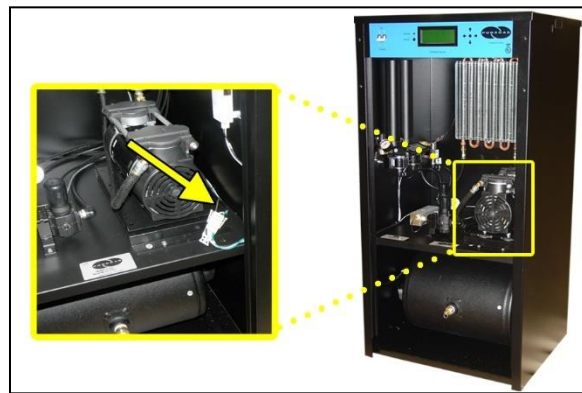

9.2.3 Use an Amp Meter to measure the Amps of the BLACK wire.

With the Compressor running, the running amps should measure:



- **8.6 amps or below** for the P4200W & P4200WLP models.
- **3.9 or below** for the P4202W & P4202WLP models.

If the Compressor measures over the recommended running amps, see section 13.16 for troubleshooting information.

9.2.4 Reinstall the Front Panel (section 8.10).

9.3 Measuring Voltage to Compressor



WARNING!

Extreme care should be exercised to avoid contact with live electrical circuits. It is highly recommended that you remove all jewelry before performing any procedures.

9.3.1 Remove the Front Panel (section 8.10).

With the Compressor running:

9.3.2 Locate the Compressor power connector.

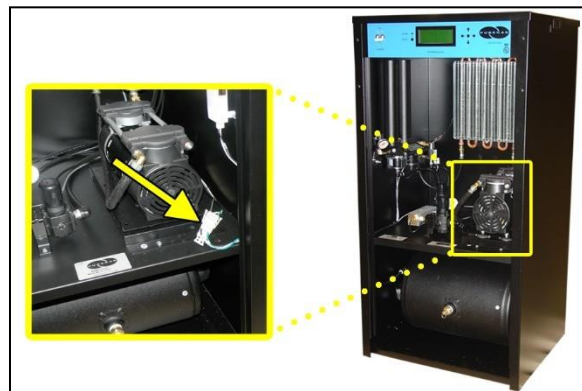

9.3.3 Use a Voltmeter to measure the voltage between the BLACK and WHITE wires:

9.3.3.1 Place the Voltmeter probes in the openings in the power connector.

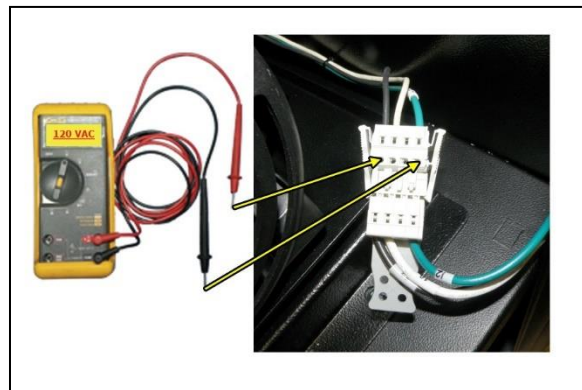

The voltage should measure:

- **110 - 125 VAC** for the P4200W & P4200WLP models.
- **220 - 230 VAC** for the P4202W & P4202WLP models.

9.3.4 Reinstall the Front Panel (section 8.10).

9.4 Measuring Incoming Voltage



WARNING!

Extreme care should be exercised to avoid contact with live electrical circuits. It is highly recommended that you remove all jewelry before performing any procedures.

9.4.1 Remove the Top Cover (section 8.11).

9.4.2 Locate the Power IEC Inlet

EMI Filter inside the Top Section of the air dryer.

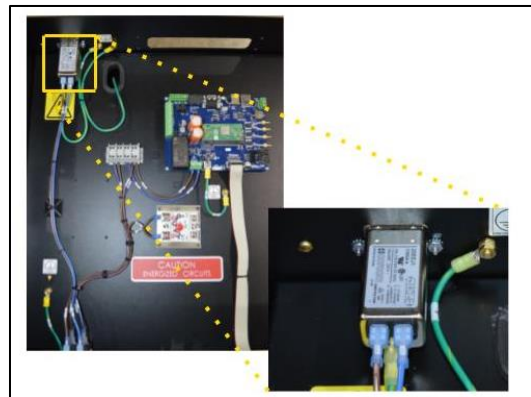

9.4.3 Use a Voltmeter to measure the voltage:

9.4.3.1 Place the probes between the IEC-Inlet EMI Filter and terminal insulation so that they touch the metal contacts.



The voltage should measure:

- **110 - 125 VAC** for the P4200W & P4200WLP models.
- **220 - 230 VAC** for the P4202W & P4202WLP models.

If the incoming voltage measures less than indicated above, it is recommended that steps be taken at your facility to bring the power to the recommended level of voltage.

9.4.4 Reinstall the Top Cover (section 8.11).

9.5 Measuring Voltages at Solid State Relay

9.5.1 Remove the Top Cover (section 8.11).

9.5.2 Locate the Solid State Relay inside the Top Section of the air dryer.

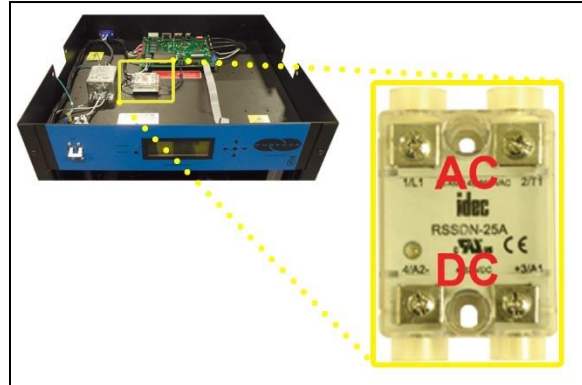

With the Compressor running:

9.5.3 Use a Voltmeter to measure across the AC terminals.

The voltage should measure **0 VAC**.

9.5.4 Use a Voltmeter to measure across the DC terminals.

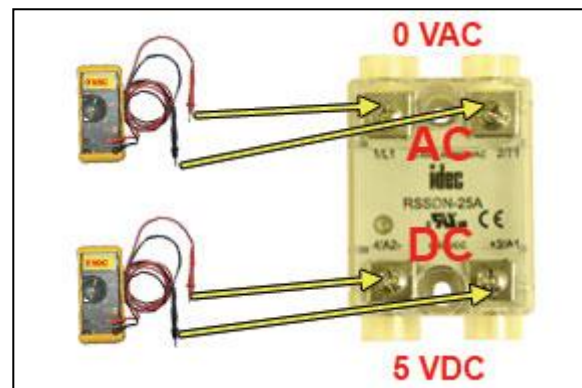

The voltage should measure:

- **5 VDC** for the P4200W & P4200WLP models.
- **12 VDC** for the P4202W & P4202WLP models.

With the Compressor NOT running:

9.5.5 Use a Voltmeter to measure across the AC terminals.

The voltage should measure:

- **110 - 125 VAC** for the P4200W & P4200WLP models.
- **220 - 230 VAC** for the P4202W & P4202WLP models.

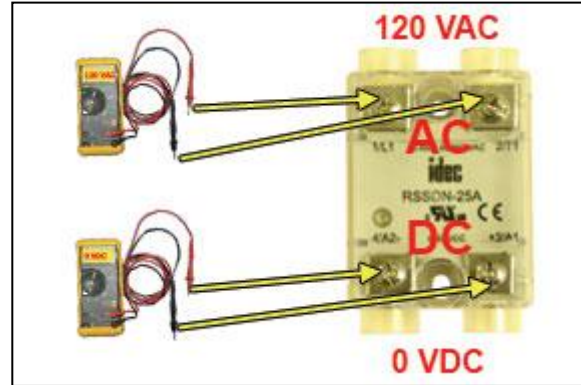

9.5.6 Use a Voltmeter to measure across the DC terminals.

The voltage should measure **0 VDC**.

9.5.7 Reinstall the Top Cover (section 8.11).

If any of the voltage measurements are different than indicated above, the Solid State Relay is defective and should be replaced. See sections 0for part detail and 0for ordering information.

9.6 Testing Consistent Heatless Dryer Cycling

9.6.1 Remove the Front Panel (section 8.10).

With the Compressor running:

9.6.2 Disconnect the purge tubes from the Heatless Dryer.



9.6.3 Place your hand beneath the purge fittings to feel for purging air. Air should:

- Purge from Tower 1 side
- Purge from Tower 2 side
30 Seconds later
- Purge from Tower 1 side
30 Seconds later
- ...and so on.

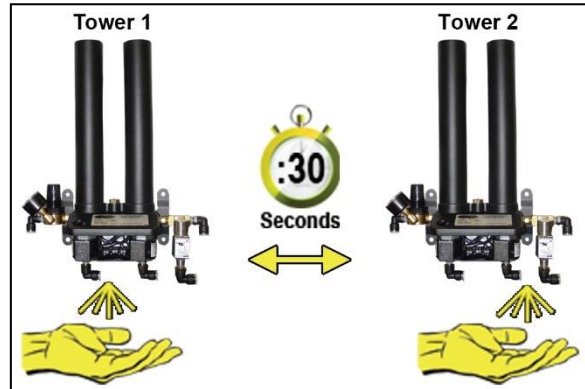

9.6.4 Re-connect the purge tubes to the Heatless Dryer.

9.6.5 Reinstall the Front Panel (section 8.10).



If the Heatless Dryer is not cycling consistently as described, see section 13.13 for troubleshooting information.

9.7 Testing Unloader Valve

9.7.1 Remove the Front Panel (section 8.10).

With the Compressor running:

9.7.2 Disconnect the unloader tube from the Unloader Valve.



- 9.7.3** Place your hand beneath the Unloader Valve fitting to feel for air flow.

Air should **NOT** flow from this fitting continuously. Air should only be released in a short burst when the Compressor shuts off.



- 9.7.4** Re-connect the unloader tube to the Unloader Valve.

- 9.7.5** Reinstall the Front Panel (section 8.10).



If air flows from this valve continuously the Unloader Valve is defective and should be replaced. See sections 11.4 for part detail and 0for ordering information.

9.8 Measuring Heatless Dryer Solenoid Voltage

- 9.8.1** Remove the Front Panel (section 8.10).

With the Compressor running:

9.8.2 Locate the Heatless Dryer Cycle Timer.

The timer has three (3) sets of terminals (from left-to-right):
“VALVE” – Left solenoid
“IN” – Incoming power
“VALVE” – Right solenoid



9.8.3 Use a Voltmeter to measure the DC voltage across each set of **“VALVE”** terminals.

Continue to measure for up to 45 seconds if no voltage is initially measured.

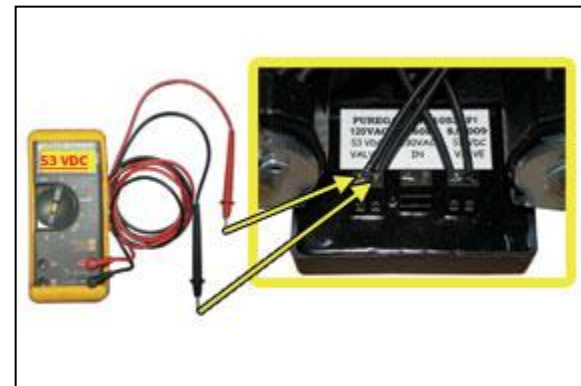

The voltage should measure:

- **53 VDC** for the P4200W & P4200WLP models.
- **106 VDC** for the P4202W & P4202WLP models.

9.8.4 Reinstall the Front Panel (section 8.10).

If the voltage does not measure as indicated above, this is an indication that the Cycle Timer is defective and should be replaced. See sections 11.4 for part detail and 0for ordering information

9.9 Testing Precooler Fan

- 9.9.1** Place your hand in front of the Precooler Fan to feel for air being blown outward.



If the fan is not blowing air outward as described:

- Check for loose wiring. Refer to the Wiring Diagram (section 14.1)
- Replace defective fan (see sections 11.3 for part detail and 0for ordering information).

9.10 Testing Safety Relief Valve

- 9.10.1** Remove the Front Panel (section 8.10).

- 9.10.2** Pull the ring handle on the Safety Relief Valve to verify air pressure is released.

- 9.10.3** Release ring handle and verify that no air is leaking from the valve.

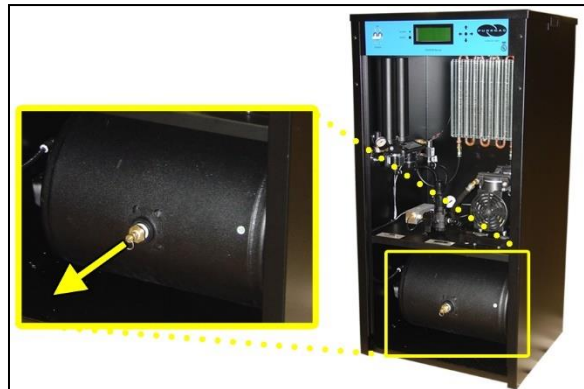

- 9.10.4** Reinstall the Front Panel (section 8.10).

If the Safety Relief Valve fails either test described, it must be replaced. See sections 11.3 for part detail and 0for ordering information.

9.11 Testing Compressor ON/OFF Cycling

9.11.1 Remove the Front Panel (section 8.10).

9.11.2 When the Outlet Screen (section 8.4.6.2) appears on the display, press the **HOLD Button** on the Front Panel to freeze that screen.

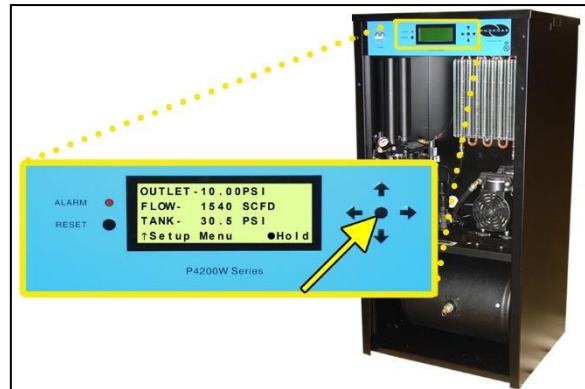

With Compressor running:

9.11.3 Verify the Compressor shuts down when the Tank Pressure (**TANK**) reaches **50.0 PSI/345 KPa**.

*If the Tank Pressure (**TANK**) fails to reach 50 PSI, see section 13.15 for troubleshooting information.*

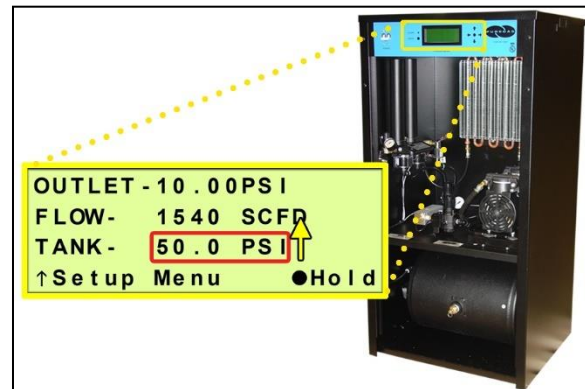

With Compressor NOT running:

9.11.4 Pull the ring handle on the Safety Relief Valve to release air pressure from the Air Tank.

9.11.5 Verify the Compressor turns on when the Tank Pressure (**TANK**) falls to **25.0 PSI/345 KPa**.



9.11.6 Reinstall the Front Panel (section 8.10).

If the Compressor Cycling fails either test described, it indicates a problem with the Control Board which may need to be replaced. See sections 0for part detail and 0for ordering information.

9.12 Testing Compressor Last Run Time Alarm

NOTE: For this test, allow the Display Screen to cycle through the information screens.

9.12.1 Remove the Front Panel (section 8.10).

9.12.2 Start timing when the Compressor turns on.

9.12.3 Pull the ring handle on the Safety Relief Valve (when necessary) to keep the Tank Pressure (**TANK**) from reaching **50 PSI/345 KPa**.
This prevents the Compressor from shutting down.



When the Compressor runs for 4:00 minutes (unless adjusted to a different threshold by the user), a Compressor Last Run Time Alarm should appear on the System Screen.

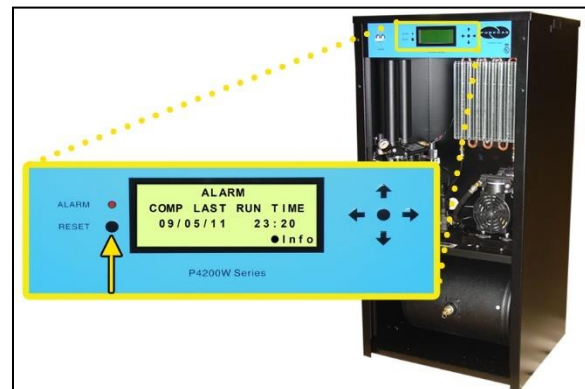

9.12.4 Press the **RESET Button** to clear the alarm.

9.12.5 Reinstall the Front Panel (section 8.10).

If you are unable to create a Compressor Last Run Time alarm as described, see section 13.18 for troubleshooting information.

9.13 Testing Humidity Alarm and System Shutdown

9.13.1 Power the air dryer **OFF**.

9.13.2 Remove the Front Panel
(section 8.10).

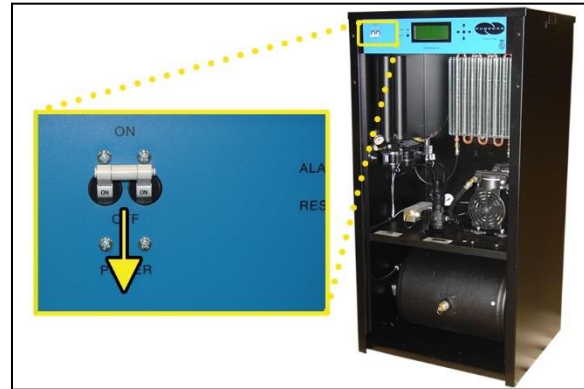

9.13.3 Depressurize the air dryer.

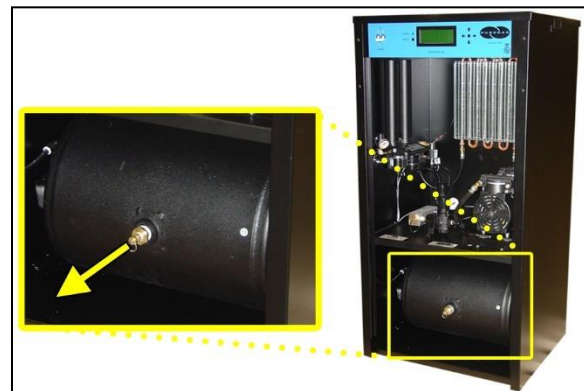

9.13.4 Unscrew and remove the
Humitter from the Combo
Block.

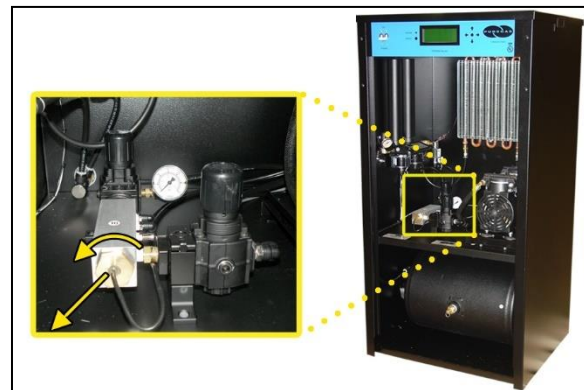

9.13.5 Power the air dryer **ON**.



9.13.6 Allow the Humidity reading to rise over 10.0%.

9.13.7 After three (3) minutes, verify that a Humidity Alarm appears and the dryer goes into **SHUTDOWN** mode.

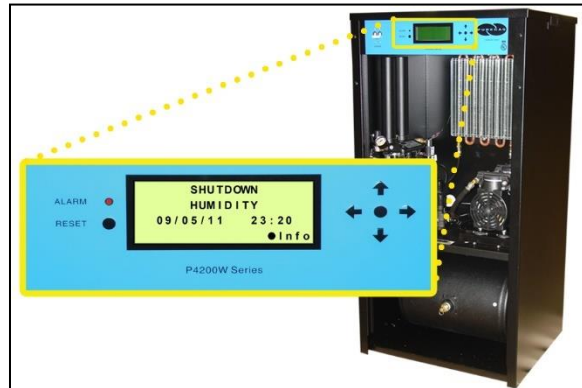

9.13.8 Replace the Humitter into the Combo Block.

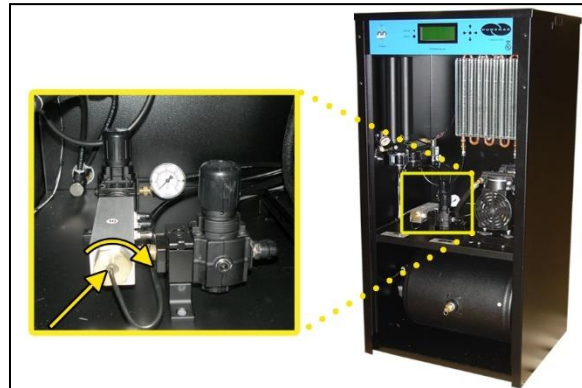

9.13.9 Press the **RESET Button** to clear the alarm.

9.13.10 Reinstall the Front Panel (section 8.10).

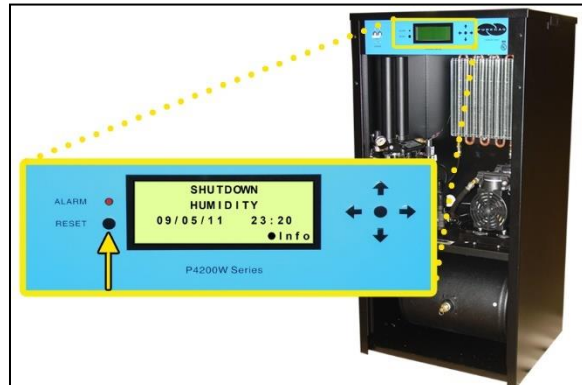

NOTE: If the Humitter is disconnected from the Control Board, **% will appear on the Humidity reading and after 5 minutes the unit will Shutdown. This is to allow for troubleshooting.

If you are unable to create a Humidity / Shutdown alarm as described, see section 13.11 for troubleshooting information.

9.14 Testing High Outlet Pressure Alarm

9.14.1 Make a note of the current Outlet Pressure (**OUTLET**) reading.

9.14.2 Remove the Front Panel (section 8.10).

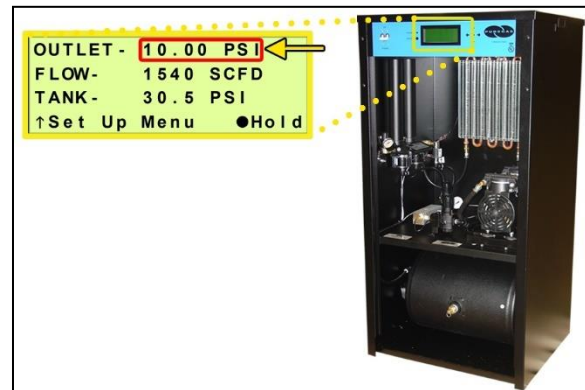

With Compressor running:

9.14.3 Pull the Outlet Pressure Regulator knob out.

9.14.4 Turn knob clockwise until Outlet Pressure (**OUTLET**) reading climbs over the alarm threshold. (section 8.8.5)

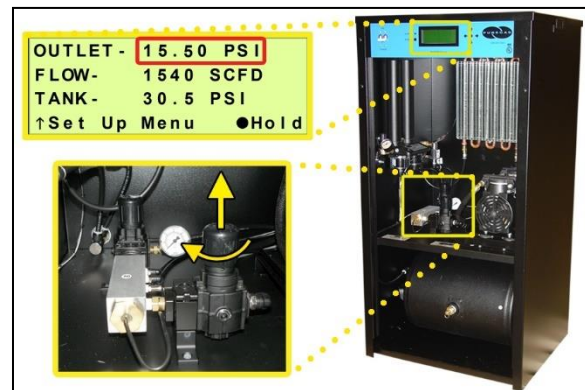

9.14.5 After one (1) minute, verify that a High Outlet Pressure Alarm appears on the display.

9.14.6 Press the **RESET Button** to clear the alarm.

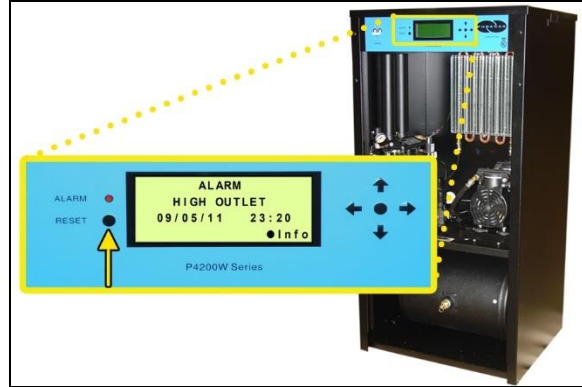

9.14.7 Turn Outlet Pressure Regulator knob counter-clockwise until Outlet Pressure (**OUTLET**) reading lowers to the reading recorded in step 9.14.1

9.14.8 Push knob in to lock.

9.14.9 Reinstall the Front Panel (section 8.10).

If you are unable to create a High Outlet Pressure Alarm as described, see section 13.6 for troubleshooting information.

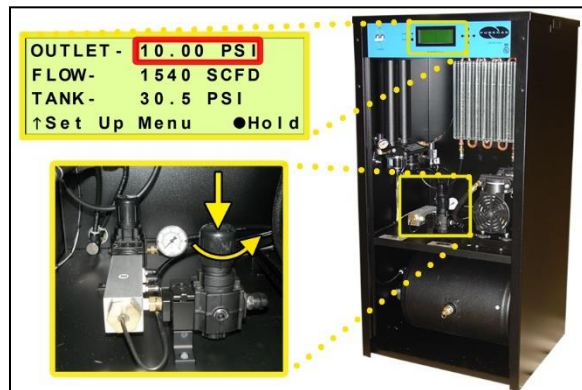

9.15 Testing Low Outlet Pressure Alarm

9.15.1 Make a note of the current Outlet Pressure (**OUTLET**) reading.

9.15.2 Remove the Front Panel (section 8.10).

With Compressor running:

9.15.3 Pull the Outlet Pressure Regulator knob out.

9.15.4 Turn knob counter-clockwise until Outlet Pressure (**OUTLET**) reading drops below the alarm threshold. (section 8.8.7)

9.15.5 After one (1) minute, verify that a Low Outlet Pressure Alarm appears on the display.

9.15.6 Press the **RESET Button** to clear the alarm.

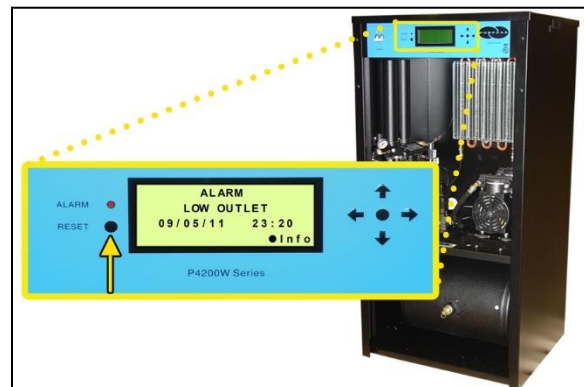
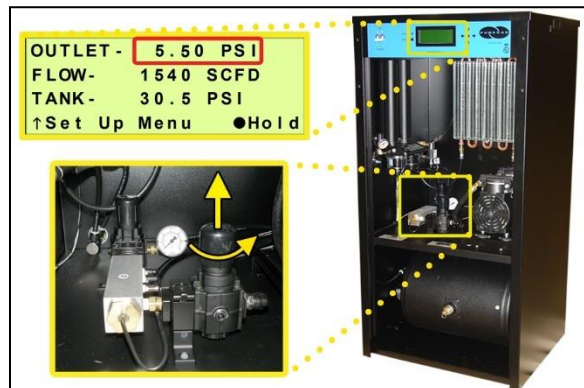
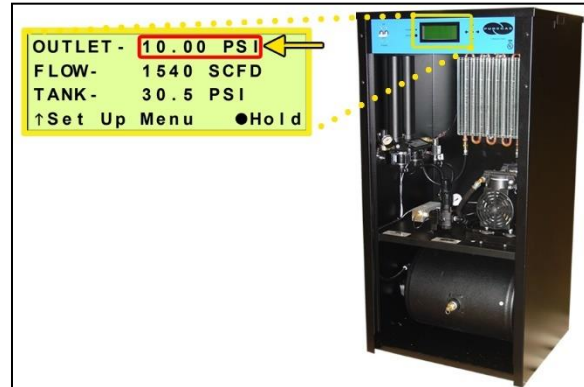

9.15.7 Turn Outlet Pressure

Regulator knob clockwise
until Outlet Pressure
(OUTLET) reading raises to
the reading recorded in step
9.15.1

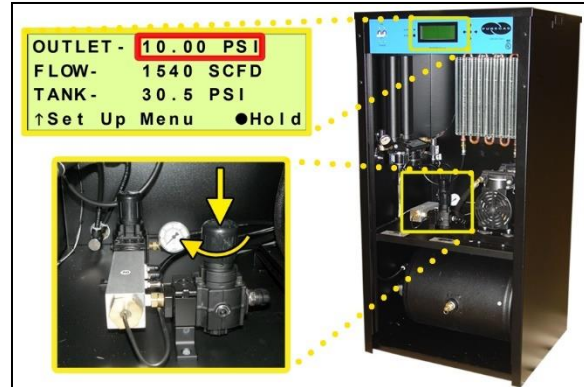
**9.15.8** Push knob in to lock.**9.15.9** Reinstall the Front Panel (section 8.10).

If you are unable to create a Low Outlet Pressure Alarm as described, see section 13.8 for troubleshooting information.

9.16 Testing Air Fittings & Hoses for Leaks

NOTE: This is a general procedure that can be applied to any fitting or hose that has air pressure in it. **DO NOT SOAP TEST THE HUMIDITY SENSOR FITTING. DAMAGE TO THE SENSOR MAY OCCUR.**

With Compressor NOT running:

9.16.1 Listen for any 'hissing' sounds which may indicate a fitting or hose air leak.

With Compressor running:

9.16.2 Use a 1-inch paint brush to dab soapy water on the air fitting or hose connection to be tested.

If air bubbles appear at the connection, this indicates that air is leaking from the connection.



If any leaks are detected, take steps to seal them off (as necessary):

- *Tighten the fitting*
- *Re-connect the hose end*
- *Replace the fitting / hose / component*

10. Maintaining Your Dryer

In order to ensure that your P4200W Series Air Dryer continues to operate efficiently and reliably, ALTEC AIR recommends performing the following maintenance procedures at the specified Six Month and 8,000 Hour intervals.

It is also recommended that you print out the included *Six Month Maintenance (section 10.2)* and *8,000 Hour Maintenance (section 10.3)* log sheets and record all completed maintenance for historical tracking and reference purposes.

The log sheets include a Section reference column which indicates the User's Guide section containing the information about the specific procedure. Please refer to these sections for detailed procedural information.

NOTE: When operating at higher ambient temperatures, it is recommended that maintenance be performed more frequently.

NOTE: After 16,000 hours of run time, ALTEC AIR recommends sending in your Compressor and Heatless Dryer for a complete and comprehensive rebuild by our Service Department technicians. *See sections 12.1 and 12.2 for information on services and contacting ALTEC AIR.*

10.1 Safety & Warning Information



WARNING!

Extreme care should be exercised to avoid contact with live electrical circuits. Many procedures performed during installation, operation, testing, and maintenance of this air dryer require the equipment to be running, creating a situation for potential electrical shock. It is highly recommended that you remove all jewelry before performing any procedures.



WARNING!

Internal surfaces may be hot. Use care when coming into contact with internal components as there is a potential for some of these components to become hot when in operation or standby.



CAUTION!

SHUT DOWN IMMEDIATELY FOR REPAIRS if the air compressor shows any evidence of overheating or presents excessive noise.



CAUTION!

Depressurizing the air dryer may be necessary before performing certain procedures. **NEVER** remove pressure sensing tubes from the Control Board without depressurizing the air dryer first, or **damage to the Control Board will occur.**



WARNING!

High Noise. Altec AIR air dryers are meant to be installed in an unattended area.

**CAUTION!**

Observe precautions for handling **Electrostatic Sensitive Devices**.

**IMPORTANT!**

After performing any maintenance, always soap test pressure fittings to check for air leaks. Also, check for any loose or disconnected wiring.

10.2 Six Month Maintenance

MODEL: _____

LOCATION NAME: _____

SERIAL NUMBER: _____

ADDRESS: _____

DATE INSTALLED: _____

Procedure	Section	Maintenance Interval (Months)				
		6	12	18	24	30
Install Six Month Maintenance Kit P012314	11.6	<input type="checkbox"/>	<input type="checkbox"/>	<input type="checkbox"/>	<input type="checkbox"/>	<input type="checkbox"/>
Read & Record Flow Rate (FLOW)	8.4.6.2					
Measure & Record Compressor Amp Draw	9.2					
Measure & Record Incoming Voltage	9.4					
Test High & Low Outlet Pressure Alarms	9.14 & 9.15	<input type="checkbox"/>	<input type="checkbox"/>	<input type="checkbox"/>	<input type="checkbox"/>	<input type="checkbox"/>
Set System Pressure (50 PSI/345 KPa)	8.14	<input type="checkbox"/>	<input type="checkbox"/>	<input type="checkbox"/>	<input type="checkbox"/>	<input type="checkbox"/>
Set Static Pressure (20 PSI/138 KPa)	8.15	<input type="checkbox"/>	<input type="checkbox"/>	<input type="checkbox"/>	<input type="checkbox"/>	<input type="checkbox"/>
Set Outlet Pressure	8.16	<input type="checkbox"/>	<input type="checkbox"/>	<input type="checkbox"/>	<input type="checkbox"/>	<input type="checkbox"/>
Test Consistent Heatless Dryer Cycling	9.6	<input type="checkbox"/>	<input type="checkbox"/>	<input type="checkbox"/>	<input type="checkbox"/>	<input type="checkbox"/>
Test Precooler Fan	9.9	<input type="checkbox"/>	<input type="checkbox"/>	<input type="checkbox"/>	<input type="checkbox"/>	<input type="checkbox"/>
Test Safety Relief Valve	9.10	<input type="checkbox"/>	<input type="checkbox"/>	<input type="checkbox"/>	<input type="checkbox"/>	<input type="checkbox"/>
Test Compressor ON/OFF Cycling	9.11	<input type="checkbox"/>	<input type="checkbox"/>	<input type="checkbox"/>	<input type="checkbox"/>	<input type="checkbox"/>
Test Compressor Last Run Time Alarm	9.12	<input type="checkbox"/>	<input type="checkbox"/>	<input type="checkbox"/>	<input type="checkbox"/>	<input type="checkbox"/>
Test Humidity Alarm & System Shutdown	9.13	<input type="checkbox"/>	<input type="checkbox"/>	<input type="checkbox"/>	<input type="checkbox"/>	<input type="checkbox"/>
Test Air Fittings and Hoses for Leaks	9.16	<input type="checkbox"/>	<input type="checkbox"/>	<input type="checkbox"/>	<input type="checkbox"/>	<input type="checkbox"/>
Clean Precooler Coils		<input type="checkbox"/>	<input type="checkbox"/>	<input type="checkbox"/>	<input type="checkbox"/>	<input type="checkbox"/>
Visually Inspect Inside & Outside of Unit for Loose Wiring or Hardware		<input type="checkbox"/>	<input type="checkbox"/>	<input type="checkbox"/>	<input type="checkbox"/>	<input type="checkbox"/>
Maintenance Performed by:						
Date of Maintenance:						

NOTE: COPY OR PRINT THIS PAGE AND KEEP IT WITH THE AIR DRYER

10.3 8,000 Hour Maintenance

Under typical operating conditions:

8,000 hours of run time will occur between one (1) and two (2) years of use.

This will be identified by a **COMPRESSOR RUN TIME: TOTAL** Alarm on the display.

MODEL: _____ LOCATION NAME: _____

SERIAL NUMBER: _____ ADDRESS: _____

DATE INSTALLED: _____

Procedure	Section	Maintenance Interval (Hours)				
		8,000	16,000	24,000	32,000	40,000
Install 8,000 Hour Maintenance Kit P011471	11.6	<input type="checkbox"/>	<input type="checkbox"/>	<input type="checkbox"/>	<input type="checkbox"/>	<input type="checkbox"/>
Read & Record Flow Rate (FLOW)	8.4.6.2					
Measure & Record Compressor Amp Draw	9.2					
Set System Pressure (50 PSI/345 KPa)	8.14	<input type="checkbox"/>	<input type="checkbox"/>	<input type="checkbox"/>	<input type="checkbox"/>	<input type="checkbox"/>
Set Static Pressure (20 PSI/138 KPa)	8.15	<input type="checkbox"/>	<input type="checkbox"/>	<input type="checkbox"/>	<input type="checkbox"/>	<input type="checkbox"/>
Set Outlet Pressure	8.16	<input type="checkbox"/>	<input type="checkbox"/>	<input type="checkbox"/>	<input type="checkbox"/>	<input type="checkbox"/>
Test Consistent Heatless Dryer Cycling	9.6	<input type="checkbox"/>	<input type="checkbox"/>	<input type="checkbox"/>	<input type="checkbox"/>	<input type="checkbox"/>
Test Compressor ON/OFF Cycling	9.11	<input type="checkbox"/>	<input type="checkbox"/>	<input type="checkbox"/>	<input type="checkbox"/>	<input type="checkbox"/>
Test Air Fittings and Hoses for Leaks	9.16	<input type="checkbox"/>	<input type="checkbox"/>	<input type="checkbox"/>	<input type="checkbox"/>	<input type="checkbox"/>
Reset COMPRESSOR TOTAL RUN TIME Reading to Zero	8.7.7	<input type="checkbox"/>	<input type="checkbox"/>	<input type="checkbox"/>	<input type="checkbox"/>	<input type="checkbox"/>
Visually Inspect Inside & Outside of Unit for Loose Wiring or Hardware		<input type="checkbox"/>	<input type="checkbox"/>	<input type="checkbox"/>	<input type="checkbox"/>	<input type="checkbox"/>
Maintenance Performed by:						
Date of Maintenance:						

NOTE: COPY OR PRINT THIS PAGE AND KEEP IT WITH THE AIR DRYER

11. Replacement Parts & Accessories

11.1 Top Section Parts

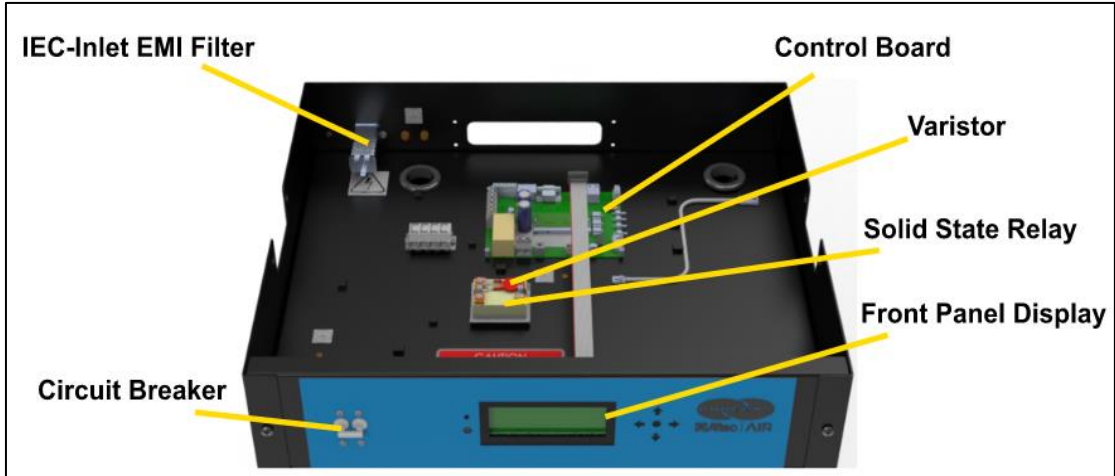

Description	Part Number		Quantity	Recommend Spare
	P4200W & P4200WLP (120 VAC)	P4202W & P4202WLP (220 VAC)		
IEC-Inlet EMI Filter	P017589		1	
Circuit Breaker	P06136		1	✓(1)
Control Board	P017795		1	✓(1)
Varistor	P012033	P012034	1	✓(1)
Solid State Relay	P05992		1	✓(1)
Front Panel Display	P012261		1	

11.2 Middle & Lower Section Parts 1

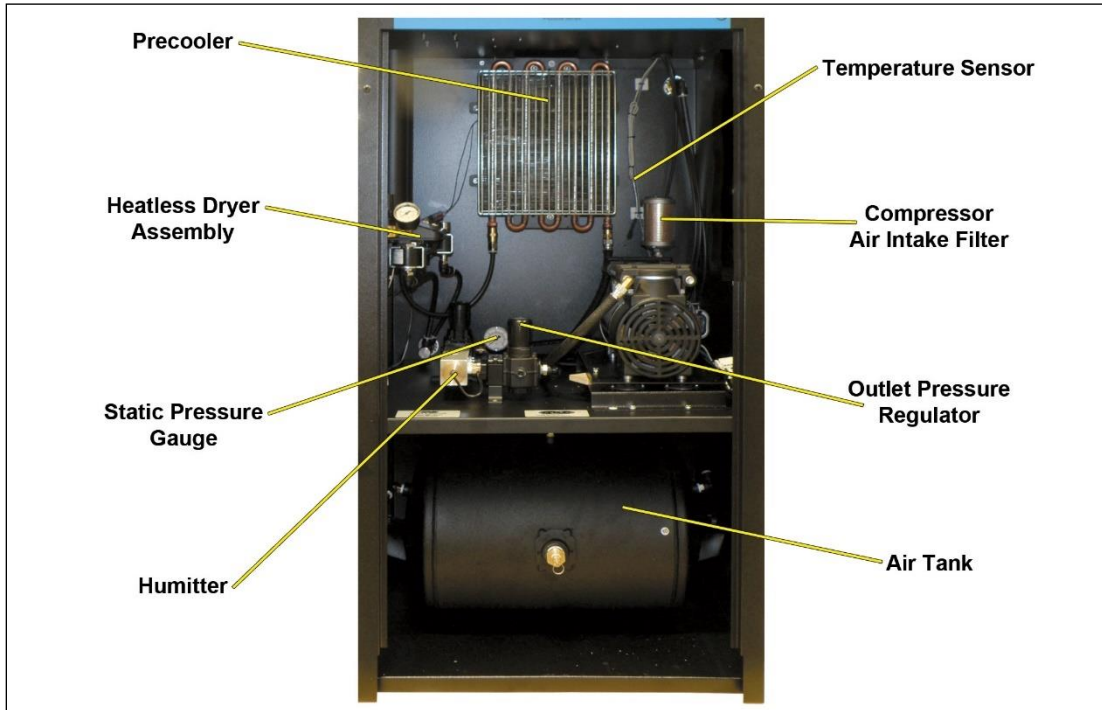

Description	Part Number		Quantity	Recommend Spare
	P4200W & P4200WLP (120 VAC)	P4202W & P4202WLP (220 VAC)		
Precooler	P4642		1	
Heatless Dryer Assembly	<i>See section 11.4 for detail</i>			
Static Pressure Gauge (0-30 PSI)	P013339		1	
Humitter	P013401		1	
Temperature Sensor	P011823		1	
Compressor Air Intake Filter	<i>In Kit P012314. See section 11.6 for detail</i>			
Outlet Pressure Regulator (Low Pressure)	P018254 (P012316)		1 (1)	✓(1)
Air Tank			1	

11.3 Middle & Lower Section Parts 2

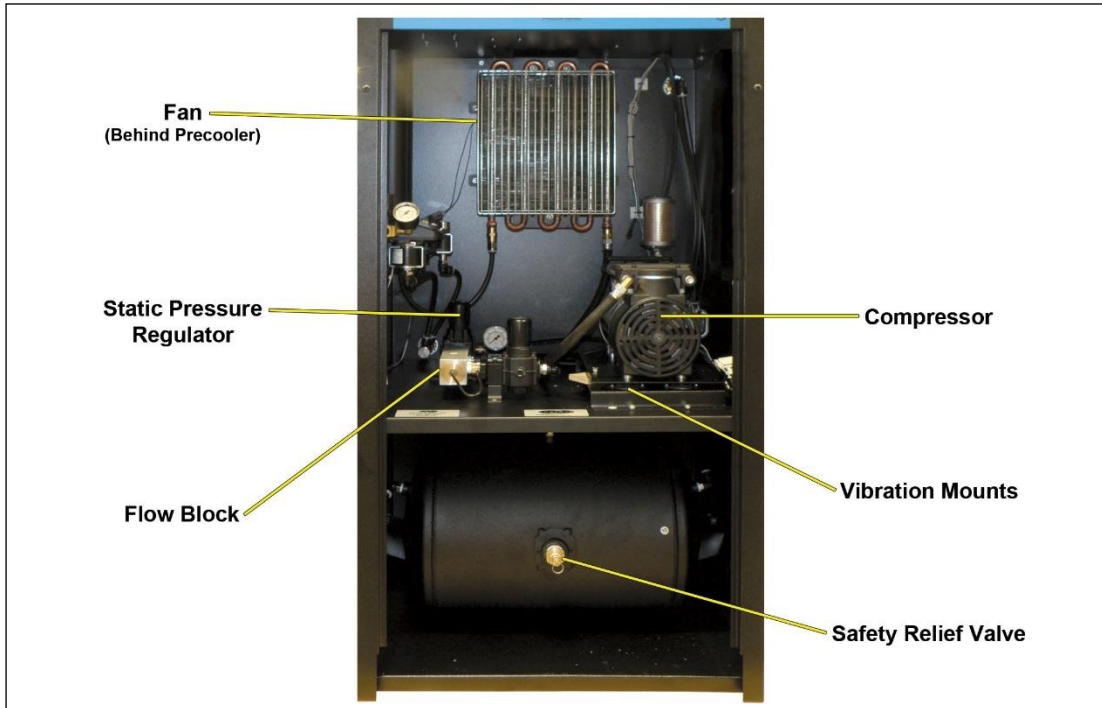

Description	Part Number		Quantity	Recommend Spare
	P4200W & P4200WLP (120 VAC)	P4202W & P4202WLP (220 VAC)		
Fan	P012366	P012368	1	
Static Pressure Regulator	P018254		1	✓ (1)
Flow Block			1	
Compressor	P013261	P013262		✓ (1)
Vibration Mounts	P4582S		4	
Safety Relief Valve	P03646		1	

11.4 Heatless Dryer Assembly Parts

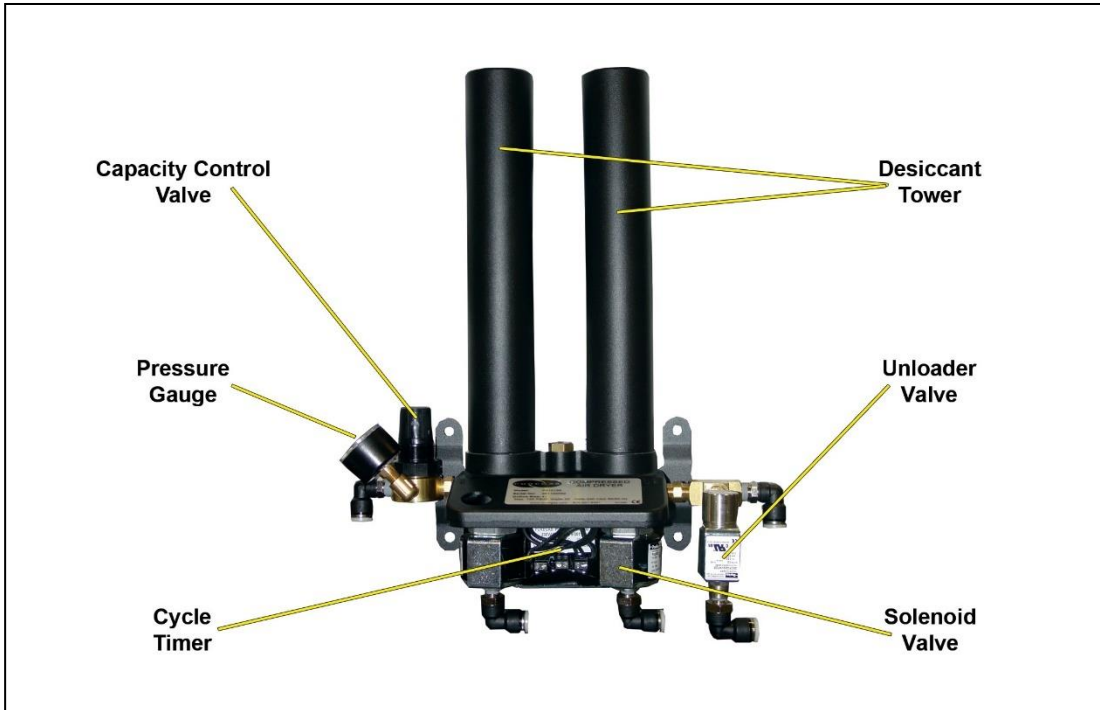





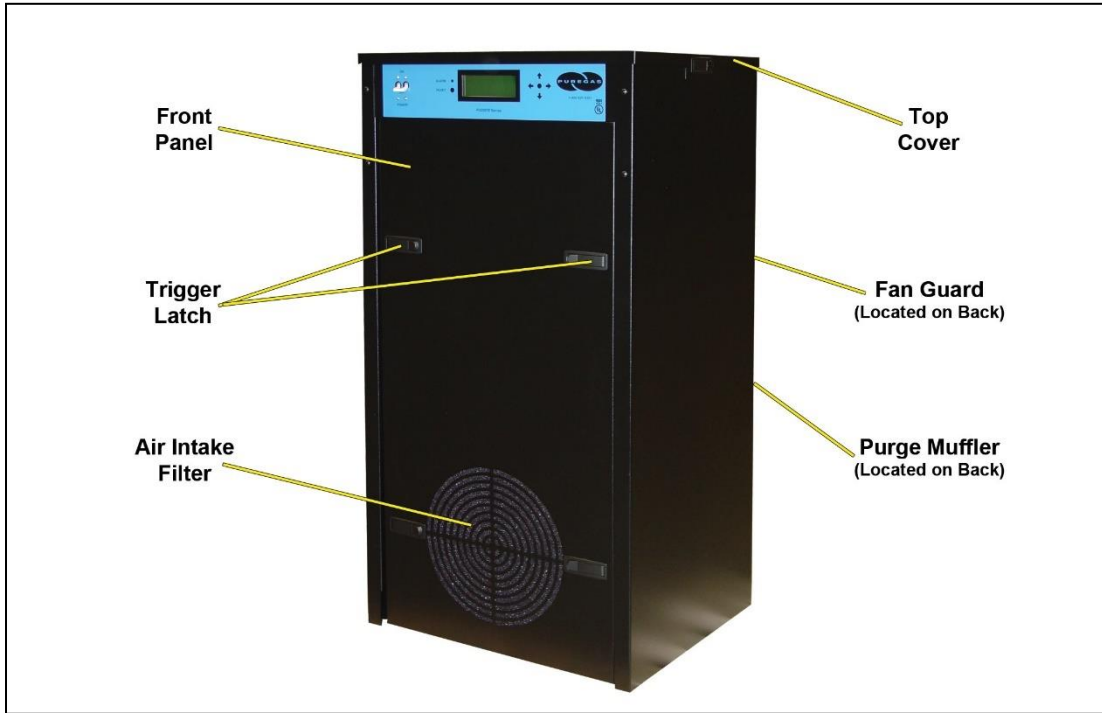

Description	Part Number		Quantity	Recommend Spare
	P4200W & P4200WLP (120 VAC)	P4202W & P4202WLP (220 VAC)		
Heatless Dryer Assembly	PHF2C112041	PHF2C212041	1	
Capacity Control Valve	P4634		1	✓ (1)
Pressure Gauge (0–100 PSI)	P010695		1	
Cycle Timer	P010530F1	P010530F2	1	
Desiccant Chamber	P20040312		2	
Unloader Valve	P011022	P010453	1	✓ (1)
Solenoid Valve	<i>In Kit P011471. See section 11.6 for detail.</i>			

11.5 Frame Section Parts



Description	Part Number	Quantity	Recommend Spare
Front Panel		1	
Locking Trigger Latches		6	
Air Intake Filter	<i>In Kit P012314. See section 11.6 for detail.</i>		
Top Cover		1	
Fan Guard	P03703	1	
Purge Muffler	<i>In Kit P012314. See section 11.6 for detail.</i>		

11.6 Accessories for Your Dryer

	Description	Part Number	Recommend Spare
	<p>Installation Kit Includes fittings required to connect to 3/4" flexible hose or 1/2" tubing.</p>	P011752	
	<p>Six Month Maintenance Kit Includes air intake filter, compressor air intake filter, and purge muffler.</p>	P012314	✓ (2)
	<p>8,000 Hour Maintenance Kit Includes heatless dryer maintenance kit and compressor maintenance kit.</p>	P011471	✓ (1)
	<p>Cycle Kit Allows multiple dryers to be cycled.</p>	P08033W	
	<p>Cycle Kit Interface Kit</p>	PVDW34	
	<p>1/2" Bleed Orifice Kit Allows the Compressor and Heatless Dryer to cycle in low flow applications.</p>	P013292	

Ordering Parts from ALTEC AIR



IMPORTANT!

Instruction for the replacement of individual listed components goes beyond the scope of this User's Guide and will not be covered. Please refer to the information included with the specific replacement part for this instruction.

Once you have identified your required parts and accessories, contact the ALTEC AIR Inside Sales / Service department to order:

(800) 521-5351 (**option 2**)

Fax – (303) 657-2205

sales@AltecAIR.com

parts@AltecAIR.com

12. Service & Repair

Only ALTEC AIR can offer factory direct rebuilds backed by a 6 month factory warranty.

- 2 week turnaround time
- Estimates available upon request
- Minimum service charge fee applies

12.1 Services Offered

- **Compressor Rebuild**
 - Replace motor bearings, piston rod assemblies, and install a complete compressor maintenance kit.
 - Test air flow, air pressure, and electrical performance
- **Heatless Dryer Rebuild**
 - Replace desiccant, o-rings, check valves, springs, and complete solenoid assembly
 - Test proper component operation
- **Desiccant Tower Repack**
 - Clean out tower and replace desiccant, filter, and o-ring
- **Circuit Board Repair** (Limited to current model boards only)
- **Complete Dryer Repair**

12.2 Initiating a Service Transaction

- Contact our Parts & Service Department at **1-800-521-5351 (option 3)** to obtain a Return Authorization (RA) number.
- Carefully package the item(s) to be returned.
- Mark the Return Authorization (RA) number on the outside of the shipping container.
- Include the main address and phone number of the individual to contact for related inquiry and follow-up information.
- Include the purchase order number.

13. Troubleshooting Your Dryer

13.1 Before You Call ALTEC AIR

PLEASE READ THIS SECTION FIRST. It is important that you use the following sections in order to diagnose and attempt to fix the problem with your air dryer before placing a call to ALTEC AIR Technical Support.

This troubleshooting guide is intended to simplify the isolation of problems, present possible causes, provide test procedures for verification, and suggest corrective actions to restore the air dryer back to normal operation. Each section begins with the most likely cause(s) of the issue. Otherwise, they start from the simplest possibilities and progress to more complicated ones.

This troubleshooting guide is designed to be easy to follow and very effective when used properly. It is suggested to always start at the beginning of the specific problem section and continue in sequence, following the procedures indicated.

13.2 Safety & Warning Information



WARNING!

For your safety, all the information in this User's Guide must be followed to minimize the risk of electrical shock, and prevent property damage or personal injury.



WARNING!

Internal surfaces may be hot. Use care when coming into contact with internal components as there is a potential for some of these components to become hot when in operation or standby.

**WARNING!**

Extreme care should be exercised to avoid contact with live electrical circuits. Many procedures performed during installation, operation, testing, and maintenance of this air dryer require the equipment to be running, creating a situation for potential electrical shock. It is highly recommended that you remove all jewelry before performing any procedures.

**CAUTION!**

Depressurizing the air dryer may be necessary before performing certain procedures. **NEVER** remove pressure sensing tubes from the Control Board without depressurizing the air dryer first, or **damage to the Control Board will occur.**

**CAUTION!**

Do not test the Humidity Sensor with an ohm meter or apply any DC voltage. This will render the Humidity Sensor defective.

**WARNING!**

High Noise. Altec AIR air dryers are meant to be installed in an unattended area.

**CAUTION!**

Observe precautions for handling **Electrostatic Sensitive Devices.**

13.3 Air Dryer Won't Power ON

Possible Cause	Check	Corrective Action
Power Circuit Breaker in OFF position	Verify Power Circuit Breaker is in ON position (section 8.3)	Move Power Circuit Breaker to ON position (section 8.3)
No voltage to the Circuit Breaker	Measure voltage to the IEC-Inlet EMI Filter (section 9.4)	If voltage is correct replace Circuit Breaker (section 0). If voltage is not correct go to next possible cause
No incoming voltage to air dryer	Measure incoming voltage (section 9.4)	Troubleshoot facility power supply to air dryer

13.4 Display Screen Not Functioning

Possible Cause	Check	Corrective Action
Dryer experienced a power spike		Power the air dryer OFF for 15+ seconds. Power the air dryer ON .

13.5 High Outlet Pressure Alarm

Possible Cause	Check	Corrective Action
Outlet Pressure set too high	Verify Outlet Pressure (OUTLET) reading (section 8.4.6.2)	Adjust Outlet Pressure Regulator (section 8.16)
High Outlet Pressure Alarm threshold too low	Verify High Outlet Pressure threshold (section 8.8.5)	Raise High Outlet Pressure threshold (section 8.8.5)

13.6 Can't Create a High Pressure Alarm

Possible Cause	Check	Corrective Action
Defective Outlet Pressure Regulator	Verify that the Outlet Pressure Regulator can be adjusted (section 8.16)	Replace Outlet Pressure Regulator if unable to adjust pressure (section 11.2)
High Outlet Pressure Alarm threshold higher than default	Verify High Outlet Pressure threshold (section 8.8.5)	Adjust Outlet Pressure Regulator so that Outlet Pressure (OUTLET) reading climbs over verified threshold (section 8.16)
Defective Control Board	Verify that the Outlet Pressure (OUTLET) reading is higher than the High Outlet Pressure threshold (above)	Replace Control Board (section 0) if Outlet Pressure (OUTLET) reading is over verified High Outlet Pressure threshold for more than 1 minute and fails to create an alarm.

13.7 Low Outlet Pressure Alarm

Possible Cause	Check	Corrective Action
Outlet Pressure set too low	Verify Outlet Pressure (OUTLET) reading (section 8.4.6.1)	Adjust Outlet Pressure Regulator (section 8.16)
High Flow condition	Verify Flow Rate (FLOW) reading is not higher than expected (section 8.4.6.2)	Troubleshoot High Flow condition (section 13.9)
Compressor will not build up pressure	Verify System Pressure (section 8.14)	Troubleshoot <i>Compressor Won't Build Pressure</i> (section 13.15)
Low Outlet Pressure Alarm threshold too high	Verify Low Outlet Pressure threshold (section 8.8.7)	Lower the Low Outlet Pressure threshold (section 8.8.7)

13.8 Can't Create a Low Pressure Alarm

Possible Cause	Check	Corrective Action
Defective Outlet Pressure Regulator	Verify that the Outlet Pressure Regulator can be adjusted (section 8.16)	Replace Outlet Pressure Regulator if unable to adjust pressure (section 11.2)
Low Outlet Pressure Alarm threshold lower than default setting	Verify Low Outlet Pressure threshold (section 8.8.7)	Adjust Outlet Pressure Regulator so that Outlet Pressure (OUTLET) reading drops below verified threshold (section 8.16)
Defective Control Board	Verify that the Outlet Pressure (OUTLET) reading is lower than the Low Outlet Pressure threshold (above)	Replace Control Board (section 0) if Outlet Pressure (OUTLET) reading is under verified Low Outlet Pressure threshold for more than 1 minute and fails to create an alarm.

13.9 High Flow Rate Alarm

Possible Cause	Check	Corrective Action
Air leak in downstream cable outside of dryer	Verify Flow Rate (FLOW) reading is not higher than expected (section 8.4.6.2)	Fix downstream problem
Air leak inside of dryer	Test fittings and hoses for leaks (section 9.16)	Reconnect or replace bad fitting / hose
High Flow Alarm threshold too low	Verify High Flow threshold (section 8.8.9)	Raise High Flow threshold (section 8.8.9)

13.10 High Humidity



CAUTION!

Do not test the Humidity Sensor with an ohm meter or apply any DC voltage. This will render the Humidity Sensor defective.

Possible Cause	Check	Corrective Action
Low System Pressure	Verify System Pressure (section 8.14)	Adjust System Pressure to 50 PSI/345 KPA (section 8.14)
Low Flow Rate	Verify Flow Rate (FLOW) reading is low (section 8.4.6.2)	Increase flow by creating an artificial leak outside of the air dryer
High Humidity Alarm threshold too low	Verify High Humidity threshold (section 8.8.3) If Flow Rate is low, allowing a higher Humidity alarm threshold (up to 10%) will allow dryer to run within acceptable levels.	Raise High Humidity threshold (section 8.8.3) Over 10% not recommended
Heatless Dryer not cycling between towers	Verify consistent Heatless Dryer cycling (section 9.6)	Troubleshoot <i>Inconsistent Heatless Dryer Cycling</i> condition (section 13.13)
Plugged or obstructed Outlet Purge	Test fittings and hoses to Outlet Purge	Remove obstruction
Defective Humitter	Perform the Testing Humidity Alarm and System Shutdown test (section 9.13)	Troubleshoot <i>Can't Create a High Humidity Alarm / Shutdown</i> condition (section 13.11)
Defective Control Board	Unplug Humitter from Control Board (see section 0 for Control Board location) Humidity reading should display **%	If Humidity reading does not display **%, replace Control Board (section 0)

13.11 Can't Create a High Humidity Alarm / Shutdown

These troubleshooting steps assume that the Humitter is removed from the Humidity Block during the *Testing Humidity Alarm and System Shutdown* (section 9.13) procedures.

Possible Cause	Check	Corrective Action
Humitter Cable disconnected	Verify that Humitter cable is connected to the Control Board	Connect Humitter cable
Defective Humitter	Verify that Humidity reading fails to climb higher than 15% or creates sporadic readings	Replace Humitter (section 11.2)
Defective Control Board	Verify that Humidity reading is over 15% for more than 1 minute	Replace Control Board if no alarm is created and system does not shut down (section 0)

13.12 High Cabinet Temperature Alarm

Possible Cause	Check	Corrective Action
Fan Failure	Verify fan is running (section 9.9)	Check for loose fan wiring (section 14.1) Replace defective fan (section 11.3)
Defective Control Board	Unplug Temperature Probe from Control Board (see section 0 for Control Board location) Cabinet Temperature reading should drop to 0°F.	If Cabinet Temperature did not drop to 0°F, replace Control Board (section 0)
High Ambient Temperature	Verify temperature of dryer operating location. Recommended ambient temperature is 40°-85°F.	Lower ambient temperature of dryer operating location

13.13 Inconsistent Heatless Dryer Cycling

Possible Cause	Check	Corrective Action
Defective Solenoid Valve	Measure voltage going to the Heatless Dryer Solenoid Valves (section 9.8)	If correct VDC IS present, replace Solenoid Valves included in the 8,000 Hour Maintenance Kit (section 11.6)
Defective Cycle Timer	Measure voltage going to the Heatless Dryer Solenoid Valves (section 9.8)	If correct VDC IS NOT present, replace the Cycle Timer (section 11.4)

13.14 Compressor Doesn't Operate

Possible Cause	Check	Corrective Action
Defective Compressor	Measure voltage to Compressor (section 9.3)	If voltage is good, replace Compressor (section 11.5) or send it in for repair (section 12.)
No power to Compressor	Measure voltage to Compressor (section 9.3)	If voltage is not present or fluctuates, continue to next Possible Cause
Defective Solid State Relay	Measure voltages at Solid State Relay (section 9.5)	If measurements are bad, replace Solid State Relay (section 0)
System is in SHUTDOWN state	On the Display Panel, verify that the system is in SHUTDOWN state	Press the RESET Button

13.15 Compressor Won't Build Pressure

Possible Cause	Check	Corrective Action
Low System Pressure	Verify System Pressure (section 8.14)	Adjust System Pressure to 50 PSI/345 KPa(section 8.14)
Defective Unloader Valve	Test Unloader Valve operation (section 9.7)	Replace Unloader Valve (section 11.4)
Leak in air system	Check all hoses and fittings between Compressor and Air Tank for air leaks (section 9.16)	Connect, tighten, or replace leaking component

13.16 Compressor Excessive AMP Draw

Possible Cause	Check	Corrective Action
Restriction in air line	Remove Discharge Hose from Compressor (see section 11.3 for location of hose) Re-measure Compressor AMP Draw (section 9.2)	If measurement is below the recommended running amps, trace hoses from Compressor to Unloader Valve looking for restrictions or kinks
Compressor failing	Remove Discharge Hose from Compressor (see section 11.5 for location of hose) Re-measure Compressor AMP Draw (section 9.2)	If measurement is still above recommended amps, replace Compressor (section 11.3) or send it in for repair (section 12.)

13.17 Compressor Last Run Time Alarm

Possible Cause	Check	Corrective Action
Low System Pressure	Verify System Pressure (section 8.14)	Adjust System Pressure to 50 PSI/345 KPa (section 8.14)
High Flow condition	Verify Flow Rate (FLOW) reading is not higher than expected (section 8.4.6.2)	Troubleshoot High Flow Alarm condition (section 13.9)
Defective Unloader Valve	Test Unloader Valve operation (section 9.7) If this is continuously flowing high amounts of air, the Unloader Valve is defective.	Replace Unloader Valve (section 11.4)
Defective Heatless Dryer Solenoid Valve	Verify consistent Heatless Dryer cycling (section 9.6) If either side is continuously flowing high amounts of air, the Solenoid Valve is defective.	Replace Solenoid Valves included in the 8,000 Hour Maintenance Kit (section 11.6)

Defective Solid State Relay	Measure voltages at Solid State Relay (section 9.5)	If measurements are bad, replace Solid State Relay (section 0)
-----------------------------	--	--

13.18 Can't Create a Compressor Last Run Time Alarm

Possible Cause	Check	Corrective Action
Compressor Last Run Time Alarm threshold higher than the default	Verify Compressor Last Run Time threshold (section 8.8.11)	Allow the Compressor to run longer than the verified threshold (section 9.12)
Defective Control Board	Verify that the Compressor has run longer than the verified Compressor Last Run Time threshold (above)	Replace Control Board (section 0) if the Compressor runs longer than the verified Compressor Last Run Time threshold by 1 minute or more and fails to create an alarm.

13.19 Compressor Rapid ON/OFF Cycling

Possible Cause	Check	Corrective Action
Defective Solid State Relay	Measure voltages at Solid State Relay (section 9.5)	If measurements are bad, replace Solid State Relay (section 0)
Defective Control Board	Measure voltages at Solid State Relay (section 9.5)	If measurements are good, replace Control Board (section 0)

13.20 Contacting ALTEC AIR Technical Support

Please read the *Before You Call ALTEC AIR* section 13.1

Once you have exhausted all of the potential problems and solutions covered in the *Troubleshooting Your Dryer* section, and you still require further assistance to correct a problem, contact ALTEC AIR Technical Support:

(800) 521-5351 (option 1)

Have the following information available:

Trouble Ticket # (if following-up on a previous call): _____
Technician Name: _____ **Phone #:** _____
Model #: _____ **Serial #:** _____
Company Name: _____ **Location Name:** _____
City: _____ **State:** _____

14. Appendix

14.1 Wiring Diagram

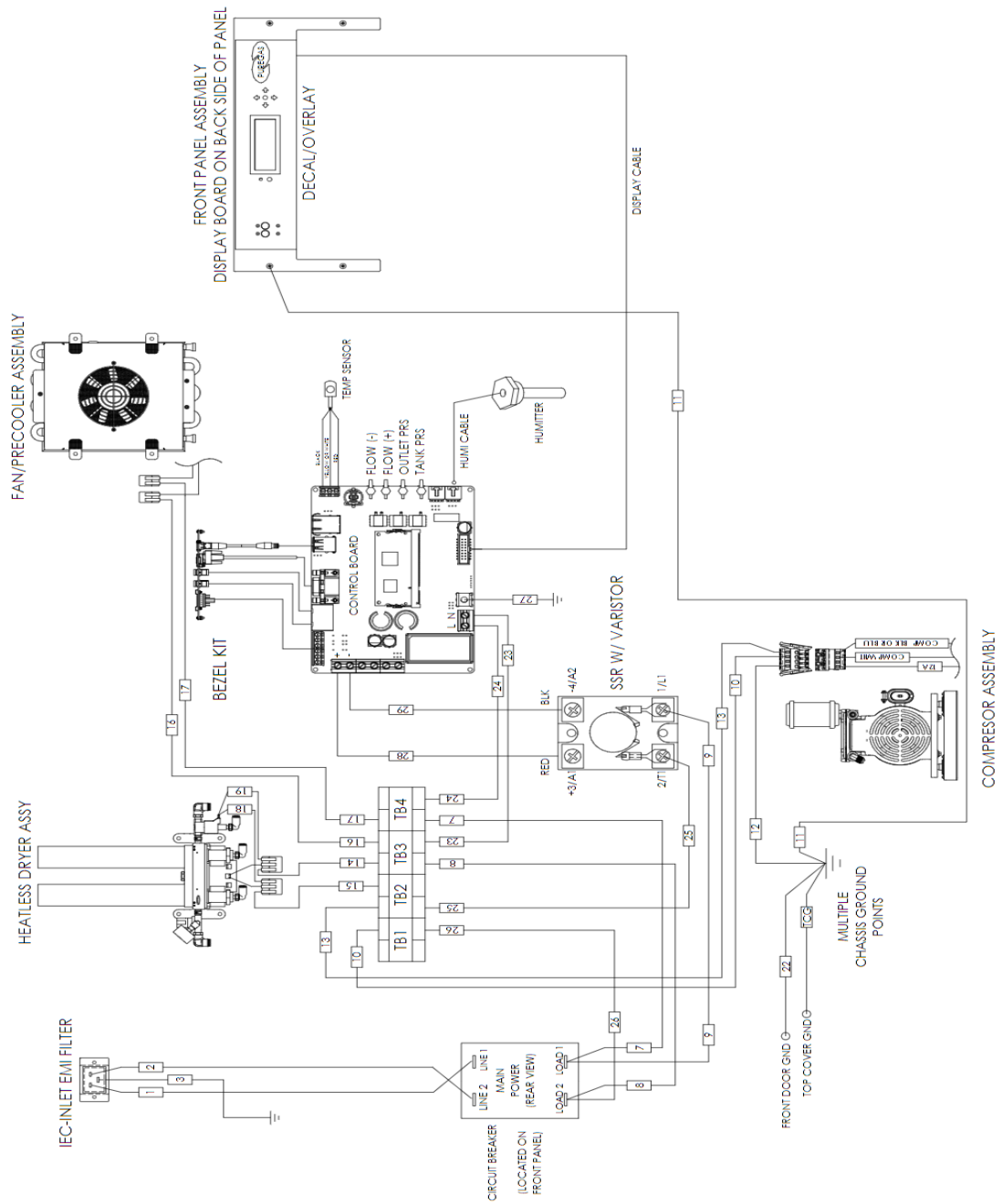

14.2 Operational Limits and Defaults

14.2.1 System Adjustments

Description	Minimum Value	Maximum Value	Default Value	Unit of Measurement
System Pressure			50/345	PSI/KPa
Static Pressure			20/138	PSI/KPa
Outlet Pressure (LP UNITS)	5.00/35 (0.30/2.0)	20.00/138 (10.00/69)		PSI/KPa
Alarm Delay	OFF	ON	ON	
Start Up Delay	0	10	0	Seconds

14.2.2 Alarm Thresholds

Description	Minimum Value	Maximum Value	Default Value	Unit of Measurement	Shutdown
High Humidity Alarm	3	15	10	%	YES
High Outlet Pressure Alarm	0.40/2.8	20.00/138	20.00/138	PSI/KPa	
Low Outlet Pressure Alarm	0.30/2	19.90/137	0.30/2	PSI/KPa	
High Flow Rate Alarm	0	4200/119	2600/74	SCFD/SCMD	
Compressor Last Run Time Alarm	0.00	10.00	4.00	Minutes	
High Duty Cycle Alarm	0	99	70	%	
Compressor Total Run Time Alarm			8000	Hours	
High Cabinet Temperature Alarm			115/46	Deg F/Deg C	Shutdown at 120°F/50°C

14.2.3 System Operations

Description	ON Value	OFF Value	Default Value	Unit of Measurement
Compressor	25/172	50/345		PSI/KPa
Fan			ON	

14.3 SNMP Parameters

Device Configuration Information

Device ID	Alphanumeric (Defined by Customer)
Device Model	Alphanumeric (Factory Preset)
Device Firmware Version	Numeric (Factory Preset)
Current Date/Time	Numeric (mm/dd/yy hh:mm)
IP Address	Numeric (xxx.xxx.xxx.xxx)
Subnet Mask	Numeric (xxx.xxx.xxx.xxx)
Gateway Address	Numeric (xxx.xxx.xxx.xxx)
SNMP Trap Server Address	Numeric (xxx.xxx.xxx.xxx)
SNMP Read Community String (also sets SNMP Trap Community String)	Alphanumeric (6-14 digits, Default = "public")
SNMP Write Community	Alphanumeric (6-14 digits, Default = "123456")

Status Readings (Read-Only)

Outlet Pressure Reading	Numeric (PSI/KPa)
Tank Pressure Reading	Numeric (PSI/KPa)
Humidity Reading	Numeric (%)
Flow Reading	Numeric (SCFD/SCMD)
Cabinet Temperature Reading	Numeric (DEG F/DEG C)
Compressor Total Run Time Reading	Numeric (Hours)
Compressor Last Run Time Reading	Numeric (Seconds)
System Status	ON / SHUTDOWN / STANDBY
Compressor Status	ON / OFF

Alarm Readings (Read-Only)

High Flow Alarm	OK / Alarm
High Outlet Pressure Alarm	OK / Alarm
Low Outlet Pressure Alarm	OK / Alarm
High Humidity Alarm	OK / Alarm
High Cabinet Temperature Alarm	OK / Alarm
Compressor Last Run Time Alarm	OK / Alarm
Maintenance Required Alarm	OK / Alarm
Total Alarm	OK / Alarm

Configuration Settings (Read-Write)

High Flow Alarm Threshold	Numeric (SCFD/SCMD)
High Outlet Pressure Alarm Threshold	Numeric (PSI/KPa)
Low Outlet Pressure Alarm Threshold	Numeric (PSI/KPa)
High Humidity Alarm Threshold	Numeric (%)
Compressor Last Run Time Alarm Threshold	Numeric (Seconds)
Reset Compressor Total Run Time Reading	Numeric (Hours)
Start Up Delay Time	Numeric (Seconds)
Alarm Delay (1 Minute)	ON / OFF
Reset Factory Defaults	SET 1 to Reset Defaults
Reset Alarms	SET 1 to Reset Alarms

Alarm Traps Sent to SNMP Server

High Flow	
High Outlet Pressure	
Low Outlet Pressure	
High Humidity	
High Cabinet Temperature	
Compressor Last Run Time	
Maintenance Required	

15. Limited Warranty Agreement

ALTEC AIR products carry a one (1) year warranty against defective workmanship and material. This period starts at date of shipment. Not included are the components subject to normal replacement during a year's operating time.

No claims for labor in replacing defective parts or for consequential damages will be allowed. Replacement parts will be invoiced in the regular way, with invoices subject to adjustment after the parts claimed defective are examined at our factory. In addition, no material or parts will be accepted at our factory for in-warranty repairs or credit without previous authorization from ALTEC AIR.

Responsibility for damages incurred in transit will be borne by the user and the user in turn should file any damage claim against the carrier. All warranty items are F.O.B. Broomfield, Colorado. Freight charges are the responsibility of the user.

This warranty shall not apply to any ALTEC AIR product which shall have been repaired or altered in any way by anyone other than ALTEC AIR or authorized personnel so as to affect, in our judgment, its proper functioning or reliability, neither will it apply to any product which has been subject to misuse, negligence, or accident. The installation of unauthorized non ALTEC AIR parts will void the warranty on those ALTEC AIR products.

Registration Reminder

If you haven't already done so, please take a moment to register your ALTEC AIR P4200W Series Air Dryer. **Registering is necessary to activate this Limited Warranty on your product.** Once you register, you are eligible to receive free technical support, as well as updates concerning your ALTEC AIR products.

See Section 7 for details on Registering Your Dryer.

16. Contacting ALTEC AIR

16.1 General

ALTEC AIR, LLC
226A Commerce Street
Broomfield, Colorado 80020

(800) 521-5351

(303) 427-3700

Fax – (303) 657-2233

info@AltecAIR.com

www.AltecAIR.com

16.2 Sales

(800) 521-5351 (**option 2**)

Fax – (303) 657-2205

sales@AltecAIR.com

parts@AltecAIR.com

16.3 Service

(800) 521-5351 (**option 3**)

Fax – (303) 657-2205

16.4 Technical Support

(800) 521-5351 (**option 1**)

DON'T FORGET TO REGISTER YOUR DRYER!

See Section 7 for details on Registering Your Dryer.

