

Installation and operating manual

Data logger

METPOINT® BDL



1. Content

- 1. General 5**
 - 1.1. Pictograms and symbols 5
 - 1.2. Signal words 5
 - 1.3. General safety instructions 6
- 2. Device features 7**
- 3. Proper use 8**
- 4. Type plate 8**
- 5. Storage and transport 9**
- 6. Technical data of BDL 10**
 - 6.1. Cable cross-sections 11
 - 6.2. Dimensions 12
- 7. Installation on site 13**
- 8. Installation 14**
 - 8.1. Safety instructions 14
 - 8.1.1. Prevention of electrostatic discharge (ESD) 16
 - 8.2. BDL wiring diagrams 17
 - 8.2.1. BDL with 4 channels 17
 - 8.2.2. BDL with 8 channels 17
 - 8.2.3. BDL with 12 channels 18
 - 8.2.4. BDL standard model 100 – 240 VAC 18
 - 8.2.5. Power supply for special version 24 VDC 18
 - 8.2.6. X2.1 and X2.2 in standard version 100 – 240 VDC, factory-wired 18
 - 8.2.7. 4 x alarm relays, max. 230VAC, 6A 19
 - 8.2.8. Bus systems X4.1 and S4.1 19
- 9. Connection of sensors 20**
 - 9.1. Pin assignment of sensors XA.1 – XA.4, XB.1 – XB.4, XC.1 – XC.4 20
 - 9.2. Connection of BEKO sensors 21
 - 9.2.1. Connection of METPOINT® SD11 / SD21 21
 - 9.2.1.1. Analogue – 2-wire, 4 ... 20 mA 21
 - 9.2.2. Connection of METPOINT® SD23 22
 - 9.2.2.1. Analogue – 4-wire, 4 ... 20 mA 22
 - 9.2.2.2. Analogue – 4-wire, 0 ... 10 V 23
 - 9.2.2.3. Digital – bidirectional RS485 bus system 23
 - 9.2.3. Connection of METPOINT® SP11 / SP21 / SP61 24
 - 9.2.3.1. Analogue – 2-wire, 4 ... 20 mA 24
 - 9.2.4. Connection of METPOINT® SP22 / SP62 25
 - 9.2.4.1. Analogue – 4-wire, 0 ... 10 V 25
 - 9.2.4.2. Analogue – 3-wire, 0 ... 10 V 25
 - 9.2.5. Connection of SF13 / SF53 26
 - 9.2.5.1. Digital – bidirectional RS485 bus system 26
 - 9.2.5.2. Analogue – 3-wire, 4 ... 20 mA 27
 - 9.2.5.3. Analogue – galvanically isolated pulse output 27
 - 9.2.6. Connection of METPOINT® FS109 / FS211 28
 - 9.2.6.1. Digital – SDI interface 28
 - 9.2.7. Connection of OCV compact 29
 - 9.2.7.1. Analogue – 2-wire, 4 ... 20 mA 29
 - 9.2.7.2. Digital – bidirectional RS485 bus system 29
 - 9.2.8. Connection of PC 400 30
 - 9.2.8.1. Digital – bidirectional RS485 bus system 30

9.2.9. Connection of PT 1000.....	30
9.2.9.1. Analogue – 4-wire, 0 ... 10 V.....	30
9.3. Connection of further sensors	31
9.3.1. Analogue – 0/4 ... 20 mA	31
9.3.1.1. Analogue – 2-wire 0/4 ... 20 mA.....	31
9.3.1.2. Analogue – 3-wire 0/4 ... 20 mA.....	31
9.3.1.3. Analogue – 4-wire 0/4 ... 20 mA.....	32
9.3.2. Analogue – 0 ... 1/10/30 V	32
9.3.2.1. Analogue – 3-wire, 0 ... 1/10/30 V.....	32
9.3.2.2. Analogue – 4-wire, 0 ... 1/10/30 V.....	33
9.3.3. SDI interface	33
9.3.3.1. Digital – 3-wire SDI-interface.....	33
9.3.3.2. Digital – 4-wire SDI-interface.....	34
9.3.4. Digital – bidirectional RS485 bus system.....	34
9.3.5. Analogue – galvanically isolated pulse sensors	35
9.3.6. Resistance sensors.....	36
9.3.6.1. Analogue – 2-wire resistance sensors.....	36
9.3.6.2. Analogue – 3-wire resistance sensors.....	36
9.3.6.3. Analogue – 4-wire resistance sensors.....	37
9.4. Connection of external displays (PLC / ZTL).....	37
9.4.1. Analogue – 0/4 ... 20 mA	37
9.4.1.1. Analogue – 2-wire 0/4 ... 20 mA.....	37
9.4.1.2. Analogue – 3-wire 0/4 ... 20 mA.....	38
9.4.1.3. Analogue – 4-wire 0/4 ... 20 mA.....	38
9.4.2. SDI interface	39
9.4.2.1. Digital – 3-wire SDI-interface.....	39
9.4.2.2. Digital – 4-wire SDI-interface.....	39
9.4.3. Digital – bidirectional RS485 bus system.....	40
10. Connecting the BDL with a PC.....	41
11. SD card and battery.....	42
11.1. Battery replacement	42
11.2. SD card replacement.....	43
12. Operation of BDL.....	43
12.1. Main menu (home)	43
12.1.1. Initialisation	43
12.1.2. Main menu after switching-on	44
12.2. Settings	45
12.2.1. Password	45
12.2.2. Sensor settings	46
12.2.2.1. Selecting sensor type (example: BEKO Digital sensor)	46
12.2.2.2. Labelling measurements and defining resolution (decimals)	48
12.2.2.3. Recording measuring data	49
12.2.2.4. Alarm settings.....	49
12.2.2.5. Advanced settings (scaling of analog output).....	51
12.2.2.6. Dew point sensor DP 109 – SDI Digital.....	52
12.2.2.7. Labelling and configuring text fields	53
12.2.2.8. Configuring analog sensors.....	56
12.2.2.9. Type "Pulse"	58
12.2.3. Type "Modbus"	61
12.2.3.1. Selecting and activating sensor type.....	61
12.2.3.2. General Modbus settings	61
12.2.3.3. Modbus settings for METPOINT® SD23	65
12.2.4. Logger settings (data logger)	67

- 12.2.5. Device settings 71
 - 12.2.5.1. Language 71
 - 12.2.5.2. Date & time 71
 - 12.2.5.3. Network settings 72
 - 12.2.5.4. Modbus 73
 - 12.2.5.5. SD card 73
 - 12.2.5.6. System update 74
 - 12.2.5.7. Restoring factory settings 76
- 12.2.6. Report settings (optional) 77
- 12.2.7. Virtual channels (optional) 79
 - 12.2.7.1. Activating virtual channels 79
 - 12.2.7.2. Virtual channel settings 80
 - 12.2.7.3. Selecting sensor type 80
 - 12.2.7.4. Configuring virtual values 81
 - 12.2.7.5. Resolution of decimal places – labelling and recording data values 85
 - 12.2.7.6. Example: calculation of "specific performance" 86
- 12.2.8. Analog total (optional) 88
 - 12.2.8.1. Activating "Analog total" option 88
 - 12.2.8.2. Selecting sensor type 88
- 12.3. Charts 90
- 12.4. Chart/current values 95
- 12.5. Current values 97
- 12.6. Alarm overview 97
- 12.7. Other settings 98
 - 12.7.1. Brightness 98
 - 12.7.2. Calibrating touch screen 99
 - 12.7.3. Cleaning 99
 - 12.7.4. System overview 100
 - 12.7.5. About BDL 100
- 12.8. Report/consumption analysis with costs – exporting data 100
 - 12.8.1. Report/consumption analysis (optional) 101
 - 12.8.2. Costs (optional) 103
- 12.9. Web server (optional) 104
 - 12.9.1. Activating web server 104
 - 12.9.2. Web server configuration 105
 - 12.9.2.1. Network settings 105
 - 12.9.3. User interface 106
 - 12.9.3.1. Information 106
 - 12.9.3.2. Selecting language 106
 - 12.9.4. Login 107
 - 12.9.5. Favourites 107
 - 12.9.6. Status 108
 - 12.9.7. Current value 108
 - 12.9.8. Display 109
 - 12.9.9. Chart 110
 - 12.9.10. AlarmMail 111
 - 12.9.10.1. User 112
 - 12.9.10.2. EMail 113
- 12.10. Exporting data 114
 - 12.10.1. Creating screenshots 116
 - 12.10.2. Exporting screenshots 117
- 13. Cleaning/decontamination 118**
- 14. Dismantling and disposal 119**
- 15. Declaration of Conformity 120**

1. General

1.1. Pictograms and symbols



General instructions



Observe installation and operating instructions



Observe installation and operating instructions
(on type plate)



General hazard symbol (danger, warning, caution)

1.2. Signal words

DANGER

Imminent danger

Consequences of non-compliance: serious or even fatal injury

WARNING

Potential danger

Consequences of non-compliance: serious or even fatal injury

CAUTION

Imminent danger

Consequences of non-compliance: injury and/or damage to property

NOTICE

Potential danger

Consequences of non-compliance: injury and/or damage to property

IMPORTANT

Additional notes, tips and hints

Consequences of non-compliance: inefficient operation, extra maintenance work; no further risks

1.3. General safety instructions

NOTICE	Before reading this manual, make sure that it refers to your device model.
	Strictly observe all safety instructions provided in this operating manual. It provides general information and instructions for the installation, operation and maintenance of your device. Therefore, it is important that the installation technicians and all operators / skilled technical personnel read these instructions prior to installation, start-up and maintenance. A copy of this installation and operating manual must be kept near the METPOINT® BDL where it is at all times accessible to staff. In addition to this installation and operating manual, observe all applicable local and statutory regulations. Ensure that the METPOINT® BDL is only operated within the permissible limits as specified on the type plate. Non-compliance might result in injury or damage to property, malfunction or device failure. If you have any queries regarding the content of this installation and operating manual, please contact BEKO TECHNOLOGIES GmbH.

Warning!	Risk of injury to personnel with insufficient qualification!
	Incorrect operation of the device might cause serious injury or damage to property. All tasks described in this operating manual must be performed by skilled technical personnel who meet the criteria outlined below.

Skilled technical personnel

Skilled technical personnel are persons who, due to their professional qualification and knowledge in the field of measuring, control and pneumatic technology, and their knowledge of the applicable statutory regulations, guidelines and standards are in a position to foresee potential dangers in relation to the use of the device and who are qualified to perform the tasks described in this manual.
 Special operating conditions (e.g. aggressive media) require additional knowledge.

Caution!	Malfunction of BDL
	Incorrect installation or insufficient maintenance can result in malfunction of the BDL, so that the incorrect values are displayed.

Danger!	Inadmissible operating parameters!
	If the specified limits are exceeded, there is a risk of device malfunction, potentially resulting in injury and/or damage to property.

Actions:

- Make sure that the BDL is operated only within the permissible limit value range indicated on the type plate.
- Strictly comply with the performance data of the BDL permissible for your application.
- Always adhere to the specified transport and storage temperatures.

Additional safety instructions:

- For the installation and operation of the device, always comply with the statutory safety regulations.
- Do not operate the BDL in potentially explosive atmospheres.

Additional instructions:

- Prevent overheating of the device!

2. Device features

The BDL has been developed and designed by engineers who have many years of practical experience in measuring and control technology. The BDL caters for a range of tasks – from measurement recoding, automatic sensor detection and display of measurements on the large colour display, alarm signal output and data storage to remote data access via web server. An alarm message can be sent by e-mail through the web server and the Ethernet connection.

All relevant information is displayed on the large 7" colour display with touch screen designed for intuitive operation. The display shows measurements, curves and limit exceedances. To trace a curve from the start of the measurement, simply follow it with your finger.

The system caters for daily, weekly and monthly reports including costs in the currency of your choice (e.g. €) and m³ counter readings for all consumption sensors.

The user-friendly setup steps and the evaluation options for measurements are two of the main advantages of the BDL over conventional paperless screen recorders. All sensors are detected and powered by the BDL. Everything is thus perfectly matched for trouble-free operation.

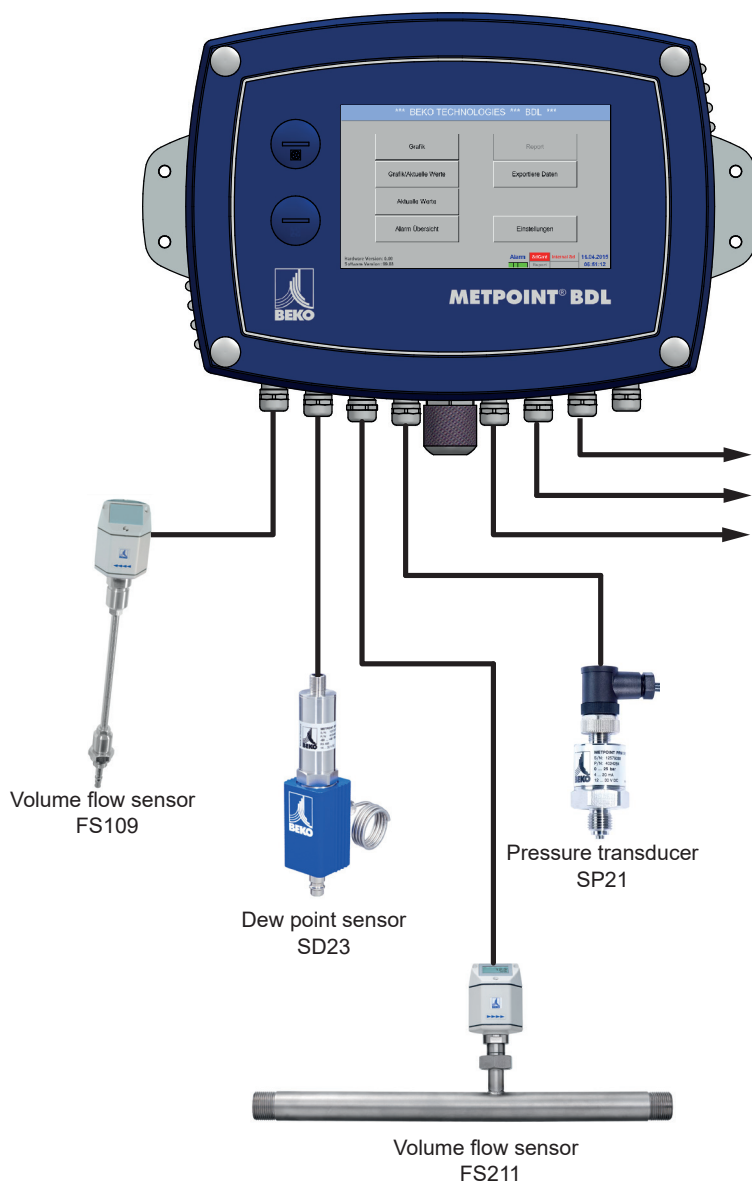

Multifunctional:

The BDL automatically detects up to 12 sensors including all BEKO sensors (consumption, dew point, pressure, current, KTY, Pt100, Pt1000).

Analog sensors (0/4 – 20 mA, 0 – 1/10/30 V, pulse) can be connected and configured in user-friendly menus. Digital sensors can be connected via RS 485, Modbus RTU, and SDI.

Alarm relays / error messages:

Up to 32 limit values can be configured and assigned to 4 different alarm relays. The BDL caters for collective alarms.

Flexible:

Network-compatible, data transmission via Ethernet, integrated web server.

3. Proper use

The METPOINT® BDL data logger has been specifically designed for the stationary measured data acquisition and storage of analog and digital input signals.

The METPOINT® BDL data logger is exclusively designed and constructed for the proper application purpose that is described herein and must only be used correspondingly.

A check in order to ascertain whether or not the device is suitable for the chosen employment must be carried out by the user. Ensure that the parts that come into direct contact with the medium are compatible with the medium. The technical data specified in data sheet are binding.

Improper handling or operation of the device outside the technical specifications is not permissible. Claims for compensation for damage caused by improper use are excluded.

4. Type plate





The type plate is attached to the device housing. It contains all relevant technical data of the METPOINT® BDL. Please have these details to hand when contacting the manufacturer or supplier:

METPOINT®BDL
 Supply Voltage: 100 ... 240 VAC / 1PH / PE
 Frequency Range: 50 ... 60 Hz
 Max. Power Input: 75 VA
 Degree of Protection: IP65
 Ambient Temperature: 0 ... +50 °C
 Weigth: 7,3 kg

Type: 4055088
 S/N: 12319345



www.beko-technologies.com
 Made in Germany









METPOINT® BDL:	Product designation
Supply Voltage:	Supply voltage
Frequency Range:	Frequency range
Max. Power Input:	Max. power consumption
Degree of Protection:	IP class
Ambient Temperature:	Ambient temperature
Weight:	Weight
Type:	Internal product no. (example)
S/N:	Serial no. (example)

NOTICE	Type plate
	Do not remove or cover the type plate, and protect it against damage.

5. Storage and transport

Despite our best efforts regarding packaging, etc., the device might be damaged during transport. Upon receipt, please remove all packaging material and inspect the METPOINT® BDL for visible damage. If you detect such damage, immediately notify the carrier company and BEKO TECHNOLOGIES GmbH or one of its agents.

Warning!	Overheating
	Overheating can damage the evaluation electronics. Observe the permissible storage, transport and operating temperature (protect measuring device from direct sunlight).

Warning!	Risk of damage
	Incorrect transport or storage, or the use of unsuitable lifting equipment might cause damage to the METPOINT® BDL.

Preventive measures

- The METPOINT® BDL must only be transported and stored by authorised and suitably skilled technical personnel.
- To transport the device, use only suitable lifting gear that is in proper working order.
- Always observe the relevant statutory requirements.

Caution!	Risks from damaged components!
	If you suspect that the METPOINT® BDL is damaged, do not start it. Defective components might impair the operational safety of the METPOINT® BDL or result in incorrect measurements.

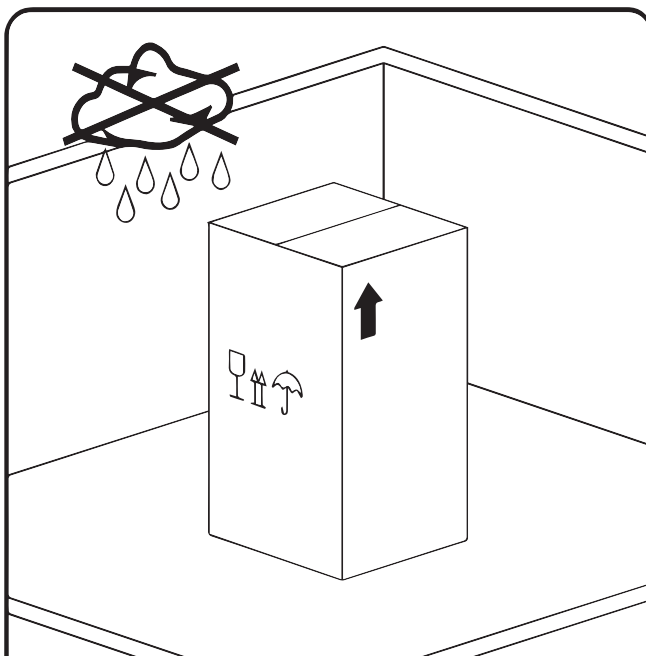

The METPOINT® BDL must be stored in the original packaging. Seal the packaging and store it in a dry and frost-free room. Ensure that the storage temperature does not exceed the limits specified on the type plate.

Even when packaged, take suitable measures to protect the METPOINT® BDL against the elements.

While in storage, secure the METPOINT® BDL so that it cannot topple over or fall, and protect it against vibration.

6. Technical data of BDL

	
Colour display	7" touch screen, TFT transmissive, for charts, curves and statistics
Supply voltage	100 – 240 VAC / 50 – 60 Hz, max. 75 VA
Supply voltage for sensors	Output voltage: 24 VDC \pm 10% electrically insulated Output current: 130 mA in continuous mode, peak 180 mA Max. output current through all channels with – one power supply: 400 mA – two power supplies: 1 A
Ambient temperature	0 ... +50 °C
Storage and transport temperature	-20 ... +70 °C
Protection class	IP 65
Connections	16 x cable terminals, M12 x 1.5, terminal size 3-7 mm 1 x RJ45 Ethernet port
Interfaces	USB memory stick, USB cable, Ethernet/RS 485 Modbus RTU/ TCP, SDI; other bus systems available on request; WEB server (optional)
Sensor inputs	4/8/12 sensor inputs for analog and digital sensors (free assignment), Digital BEKO TECHNOLOGIES GmbH sensors for dew point and consumption monitoring with SDI interface, FS109/211 DP109/110 series, Digital third-party sensors RS 485/Modbus RTU; other bus systems available on request Analog BEKO TECHNOLOGIES GmbH sensors for pressure, temperature, current clamp, preconfigure, Analog third-party sensors 0/4 – 20 mA, 0 – 1/10/30 V, pulse, Pt100/Pt1000
Dimensions of housing	Dimensions: 300 x 220 x 109 mm
Weight	7.3 kg
Housing material	Powder-coated aluminium, polyester front foil
Outputs	4 relays (max. switching voltage: 400 VAC / 300 VDC, Switching current min. 10 mA, max. 6 A), alarm management, relay freely programmable, general alarm, Analog output and pulse with sensors with own signal output, looped, e.g. DP/FS series
Memory card	2 GB memory card (standard), optional up to 4 GB
Accuracy	See sensor specifications
Optional	Web server
Optional	Fast measuring with sensing rate of 10 ms analog sensor, display of max./min. value per second
Optional	Optional consumption statistics, daily/weekly/monthly reports

Input signals		
Signal current (0 – 20 mA/4 – 20 mA) Internal or external power supply	Measuring range	0 – 20 mA / 4 – 20 mA
	Resolution	0.0001 mA
	Accuracy	± 0.003 mA ± 0.05 %
	Input resistance	50 Ω
Signal voltage (0 – 1 V)	Measuring range	0 – 1 V
	Resolution	0.05 mV
	Accuracy	± 0.2 mV ± 0.05 %
	Input resistance	100 kΩ
Signal voltage (0 – 10 V/30 V)	Measuring range	0 – 10 V/30 V
	Resolution	0.5 mV
	Accuracy	± 2 mV ± 0.05 %
	Input resistance	1 MΩ
RTD Pt100	Measuring range	-200 – 850 °C
	Resolution	0.1 °C
	Accuracy	± 0.2 °C at -100 – 400 °C ± 0.3 °C (outside above range)
RTD Pt1000	Measuring range	-200 ... 850 °C
	Resolution	0.1 °C
	Accuracy	± 0.2 °C at -100 ... 400 °C ± 0.3 °C (outside above range)
Pulse	Measuring range	Min. pulse time 100 μS Frequency 0 – 1 kHz Max. 30 VDC

6.1. Cable cross-sections

Power supply 100 – 240 VAC, 50 – 60 Hz, special version 24 VDC:
Cable cross-section of power cable: **0.75 mm²**

Sensor connections/output signals:
Cable cross-section for sensor power cable: **Terminal size 3-7 mm**

6.2. Dimensions

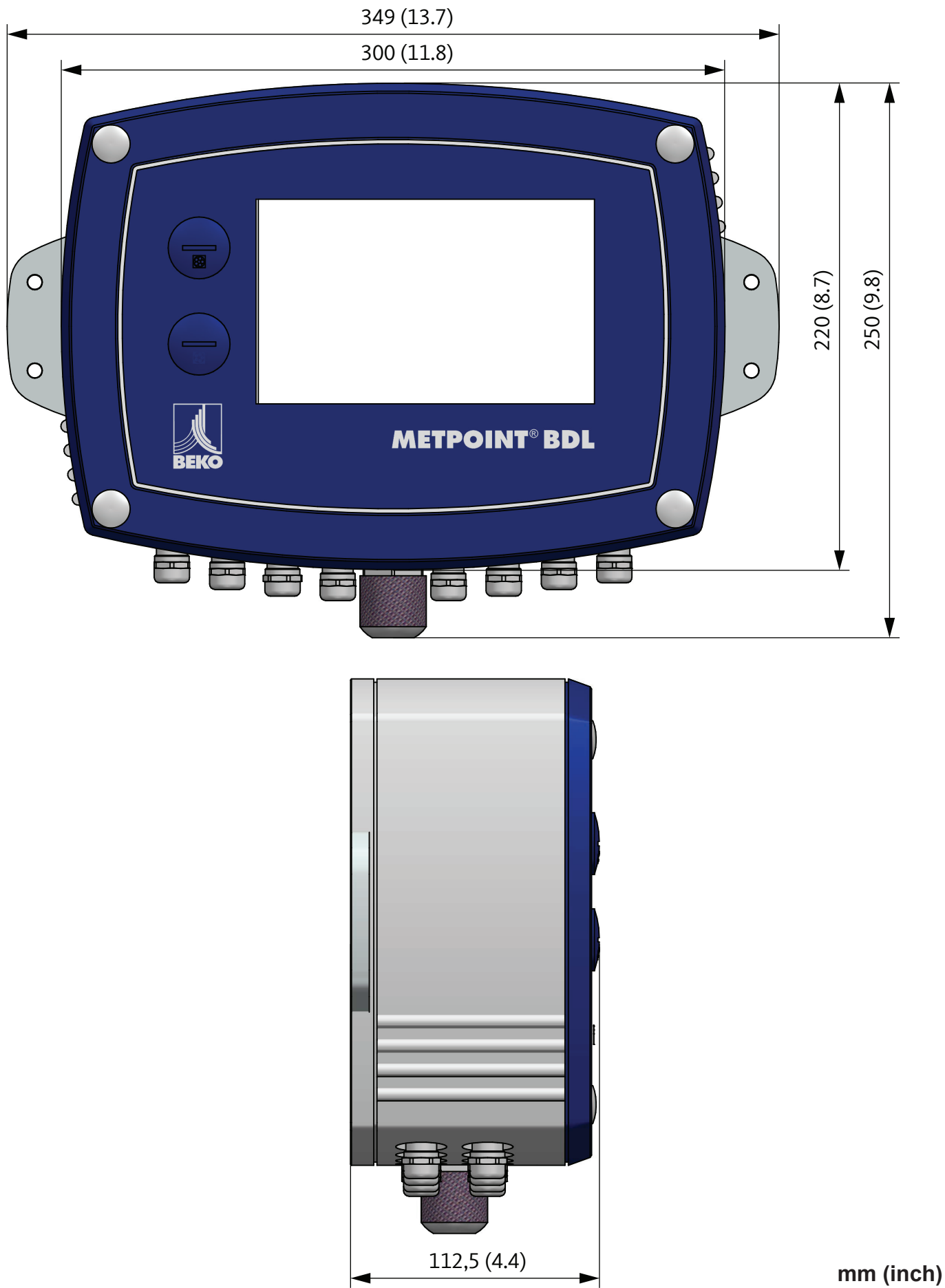

7. Installation on site

Secure the housing of the METPOINT® BDL to the wall, using suitable wall plugs and screws.

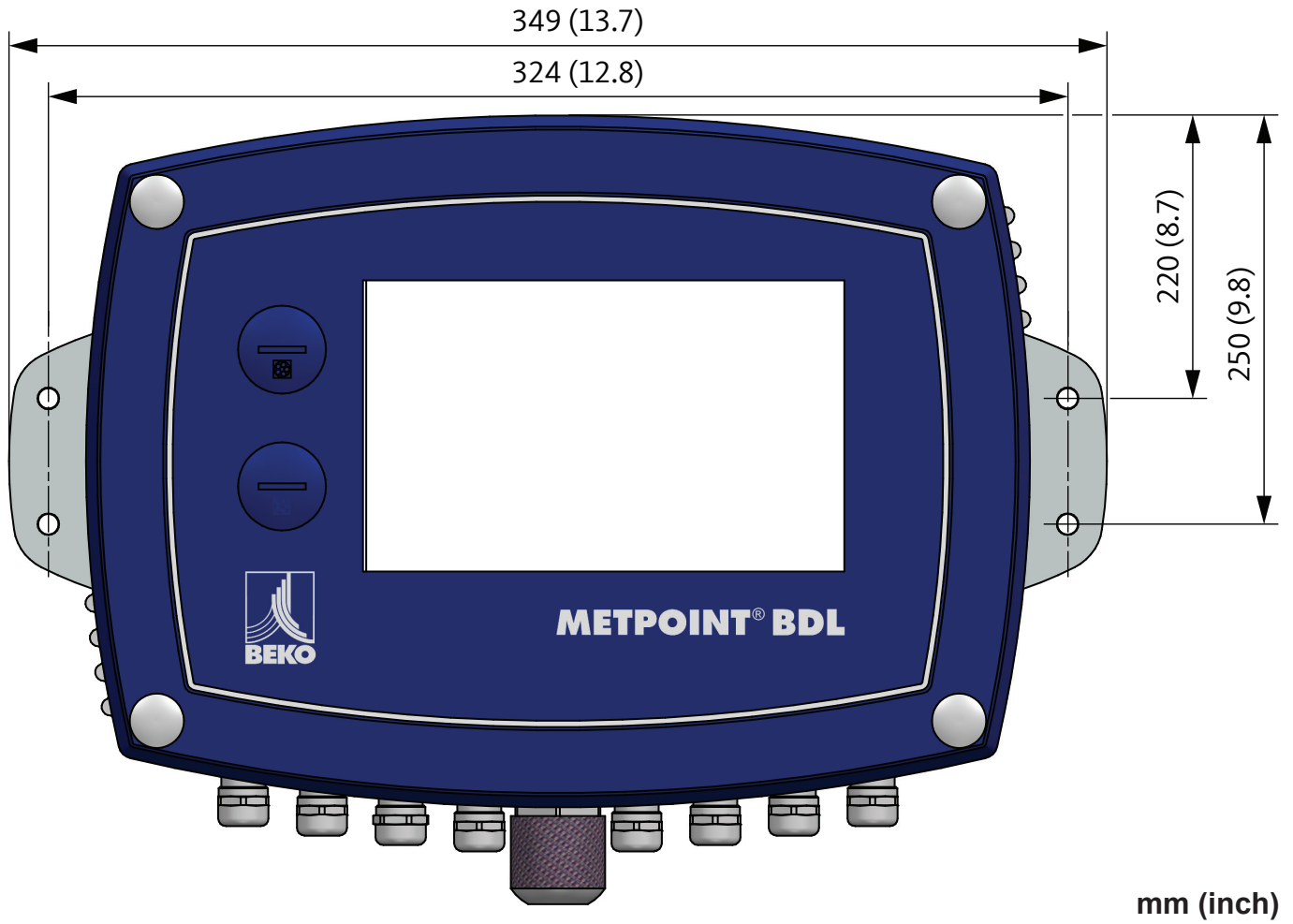

NOTICE	Wall mounting
	For wall mounting, use fixtures that can carry at least 4 times the weight of the device (7.3 kg).

8. Installation

8.1. Safety instructions

Danger!	Mains voltage
	Risk of serious or even fatal injury from electric shock when coming into contact with non-insulated, powered components.

Actions:

- For the electrical installation of the device, adhere to all applicable regulations (e.g. VDE 0100).
- All electrical work must only be carried out by authorised and skilled technical personnel.
- For the connection of the power mains and the installation of suitable safety devices, strictly adhere to all statutory regulations that apply at the location of installation of the METPOINT® BDL. The connection must be established by suitably skilled technical personnel.
- Make sure that no parts of the measuring devices are energized and that the measuring devices cannot be connected to the electric supply mains while maintenance work is in progress.

Danger!	Operation without earth connection!
	If there is a fault but no earth connection (protective earth), conductive components might become energised, posing a risk of serious or even fatal injury. The device must therefore be connected to an earth conductor. Do not use plug adapters at the power plug. If required, have the power plug replaced by a qualified electrician.

Danger!	Operation without circuit breaker!
	All components that are powered and exposed must be disconnectable by means of dedicated external circuit breakers. The circuit breaker must be installed in the vicinity of the device. The circuit breaker must conform to IEC 60947-1 and IEC 60947-3. The circuit breaker must disconnect all electrical conductors from the mains power supply. The circuit breaker must not be installed in the power supply line. The circuit breaker must at all times be easily accessible to operating personnel.

To disconnect the device from the power mains, pull the plug from the socket. Ensure that the power plug is clearly identified and easily accessible by operating personnel. The plug must conform to CEE7/7.

All electrical cables carrying supply voltage or other dangerous voltage (main supply cable, alarm cable, signalling relays) must be equipped with double or reinforced insulation (EN 61010-1). This can be achieved by using plastic-sheathed cables, a second insulation (e.g. flexible insulating tubing), or cables with reinforced insulation. The power cables can for example be protected with flexible insulating tubing. The additional flexible insulating tubing must withstand the electrical and mechanical stresses that are likely to occur in connection with the intended use (see EN 61010-1, section 6.7.2.2.1).

Danger!	Mains voltage
	When wiring the power supply line, ensure that the double or reinforced insulation between the electric circuits and the secondary circuit remains intact.

NOTICE	Insulation
	The additional insulation must be suitable for a test voltage of 1500 VAC. The thickness of the insulation must be at least 0.4 mm (e.g. insulating tubing, type BI 85 from Bierther GmbH).

The additional insulation of the power cables (mains connection, alarm and signalling relays) can be implemented as follows:

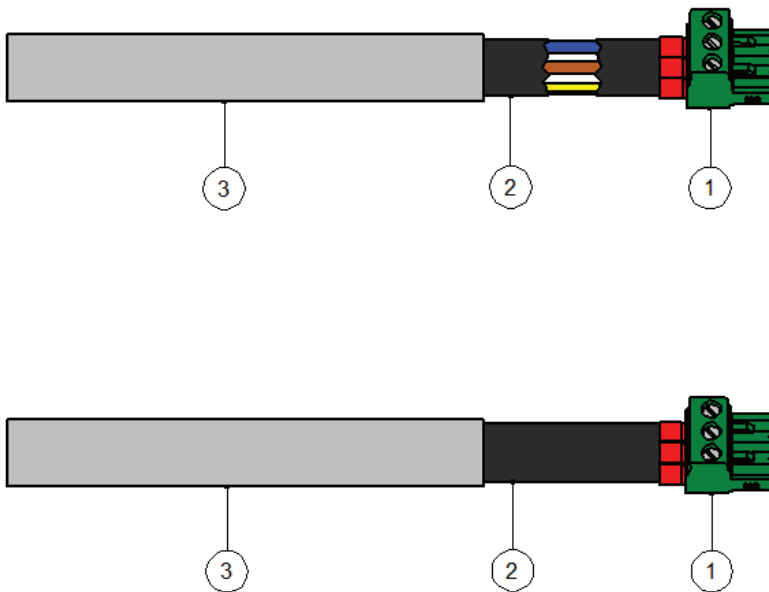

- (1) – Terminals (plug-type connectors)
- (2) – Flexible insulating tubing for the power cables
- (3) – Power cable

8.1.1. Prevention of electrostatic discharge (ESD)

Danger!	Risk of damage from ESD
	<p>The device contains electronic components that might be destroyed by electrostatic discharge (ESD). Avoid contact with persons or objects that are electrically charged. In the worst case, components sensitive to ESD might be instantly destroyed when touched or fail after start-up.</p> <p>In order to minimise or prevent possible damage from sudden electrostatic discharge, observe the requirements of EN 61340-5-1. Do not touch electronic components while they are powered.</p>

Basic safety precautions

In order not to cause damage when handling electronic devices, take the necessary precautions for the prevention of electrostatic charges laid down in DIN EN 61340-5-1, IEC 63140-5, and DIN EN 100 015.

These precautions prevent electronic discharge and thus protect your equipment.

Preventive measures

When opening the housing of the METPOINT® BDL for maintenance or servicing, take the following protective measures:

- Stand on an earthed ESD mat
- Wear a wrist strap
- Discharge tools prior to use by rubbing them over the ESD mat

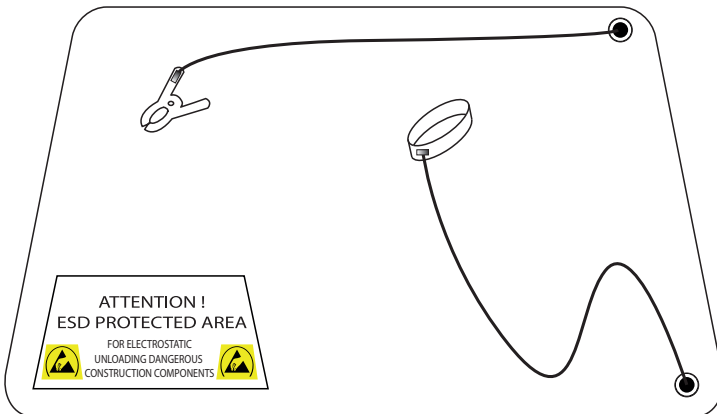

8.2. BDL wiring diagrams

Danger!	Mains voltage
	Incorrect connection of the device to the power mains can lead to serious or even fatal injury and cause malfunction of the BDL.

Preventive measures

When connecting the device to the power supply, strictly adhere to the instructions in chapters 8.1 and 8.1.1.

8.2.1. BDL with 4 channels

	<p>X1.1: Power supply</p> <p>X2.1, X2.2: For the internal use</p> <p>X3.1 – X3.4: Alarm relays 1 – 4</p> <p>X4.1, S4.1: CAN, RS485, R120 connections</p> <p>XA.1 – XA.4: Sensor channels 1 – 4</p>
--	--

8.2.2. BDL with 8 channels

	<p>X1.1: Power supply</p> <p>X2.1, X2.2: For the internal use</p> <p>X3.1 – X3.4: Alarm relays 1 – 4</p> <p>X4.1: CAN, RS485, R120 connections</p> <p>XA.1 – XA.4: Sensor channels 1 – 4</p> <p>XB.1 – XB.4: Sensor channels 5 – 8</p>
--	--

8.2.3. BDL with 12 channels

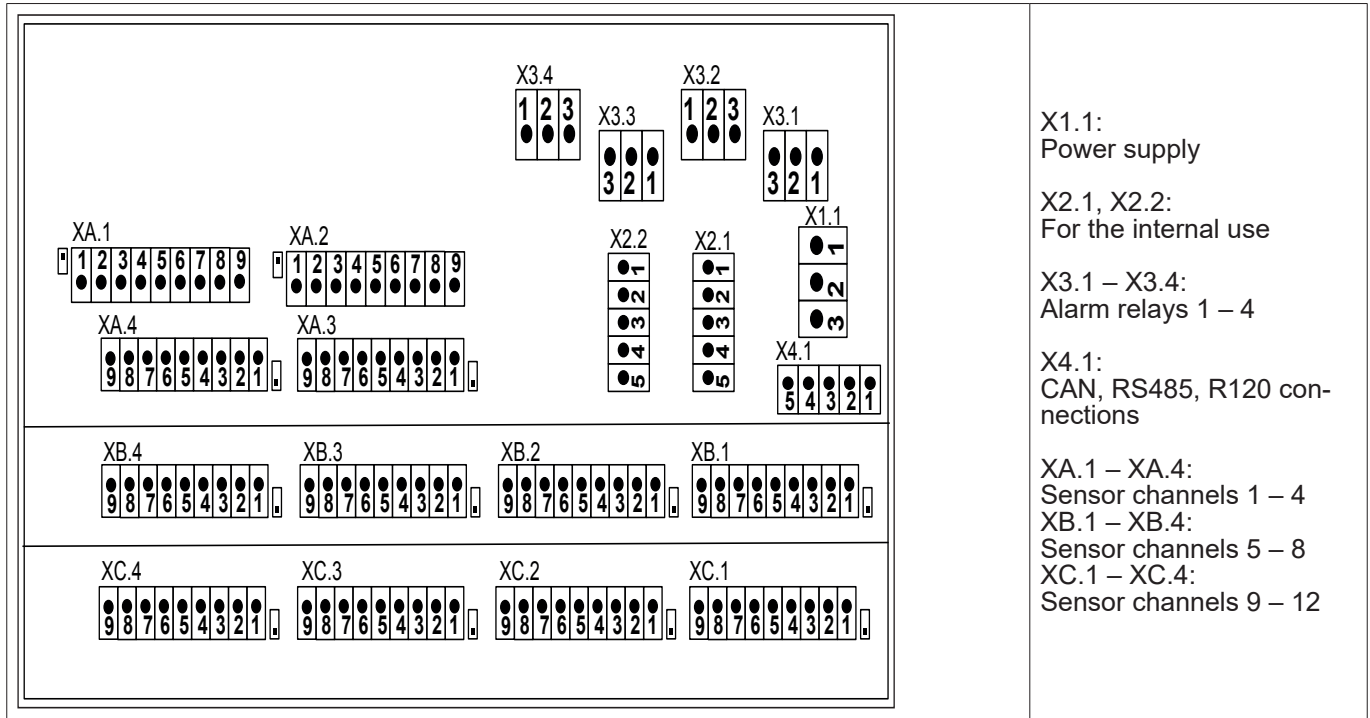

8.2.4. BDL standard model 100 – 240 VAC

<p>X 1.1</p>	<p>L1 N PE</p>	<p>100 – 240 VAC, 50 – 60 Hz</p>
---------------------	------------------------	----------------------------------

8.2.5. Power supply for special version 24 VDC

<p>X2.1</p>	<p>L1' N' PE' GND U+ (24VDC)</p>	<p>External power supply with 24 VDC (X2.2 not assigned) Internal 100 – 240 VAC/24 VDC power supplies are not connected. Connect the 24 VDC power supply to pins 4 and 5.</p>
--------------------	--	--



8.2.6. X2.1 and X2.2 in standard version 100 – 240 VDC, factory-wired

<p>X2.1; X2.2</p>	<p>L1' N' PE' GND U+ (24VDC)</p>	<p>For internal use only.</p>
--------------------------	--	-------------------------------

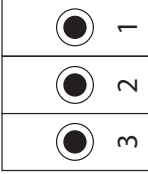
8.2.7. 4 x alarm relays, max. 230VAC, 6A

<p>X 3.1 – X3.4</p> 	<p>NO COM NC</p>	<p>X3.1: Alarm relay 1 X3.2: Alarm relay 2 X3.3: Alarm relay 3 X3.4: Alarm relay 4</p> <p>NC and COM are closed in the event of: alarm, power failure, sensor break</p>
--	--------------------------	---

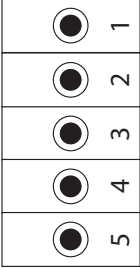
8.2.8. Bus systems X4.1 and S4.1

<p>X 4.1</p> 	<p>Z Y GND B A</p>	<p>S4.1</p> 	<p>RS485 Modbus TERMINATION 120R</p> <p>S2, S3, S7 ON S1, S8 ON</p>	<p>BDL version with 4 channels</p>
---	------------------------------------	---	---	------------------------------------









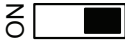

9. Connection of sensors

The values measured by consumption and dew point sensors can be output for subsequent processing in the form of analog current signals (4 – 20 mA). The output of the current signal to an external PLC/building control system or external display (third-party display) is shown in the wiring diagrams.

The following wiring diagrams apply to **XA.1 – XC.4!**

- SD/DP series = dew point transmitters
- FS series = consumption sensors
- SP series = pressure transducers

9.1. Pin assignment of sensors XA.1 – XA.4, XB.1 – XB.4, XC.1 – XC.4

XA.1 – XA.4 XB.1 – XB.4 XC.1 – XC.4	
Abschlusswiderstand RS485 	RS485 terminal resistance ON/OFF
(+) A / RS485  1	(+) A/RS485
(-) B / RS485  2	(-) B/RS485
SDI  3	SDI (internal data transmission for all dew point/consumption sensors)
Analog IN +  4	ANALOG IN + (current signal and voltage signal)
Analog IN _{GND}  5	ANALOG IN _{GND} (current signal and voltage signal)
I (500µA)  6	POWER SOURCE 500 µA
+Uv 24VDC  7	+ Uv, 24V DC power supply for sensors
-Uv GND  8	- Uv, GND sensor
Ext. Anzeige  9	- Support pin, e.g. for external signal transmission 4 ... 20mA

9.2. Connection of BEKO sensors

The connection diagram shows the options for the connection of the BEKO sensors.

Sensor	RS485	SDI	Pulse	0 – 10 V			4 – 20 mA		
				2-wire	3-wire	4-wire	2-wire	3-wire	4-wire
SD11 / SD21							X		
SD23	X					X			X
SP11 / SP21 / SP61							X		
SP22 / SP62					X	X			
SF13 / SF53	X		X					X	
FS109 / FS211		X							
OCV compact	X						X		
PC 400	X								
PT 1000						X			

9.2.1. Connection of METPOINT® SD11 / SD21

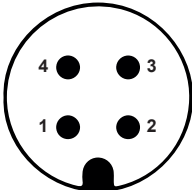
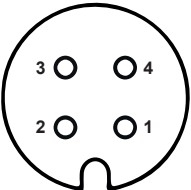
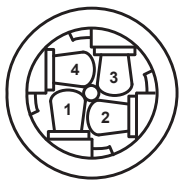
Pin assignment of plug-type connector, M12 x 1, 4-pin, A-coded		
Pin assignment of connector Transmitter side	Pin assignment of connector Bush side view	Pin assignment of connector Screw side
		

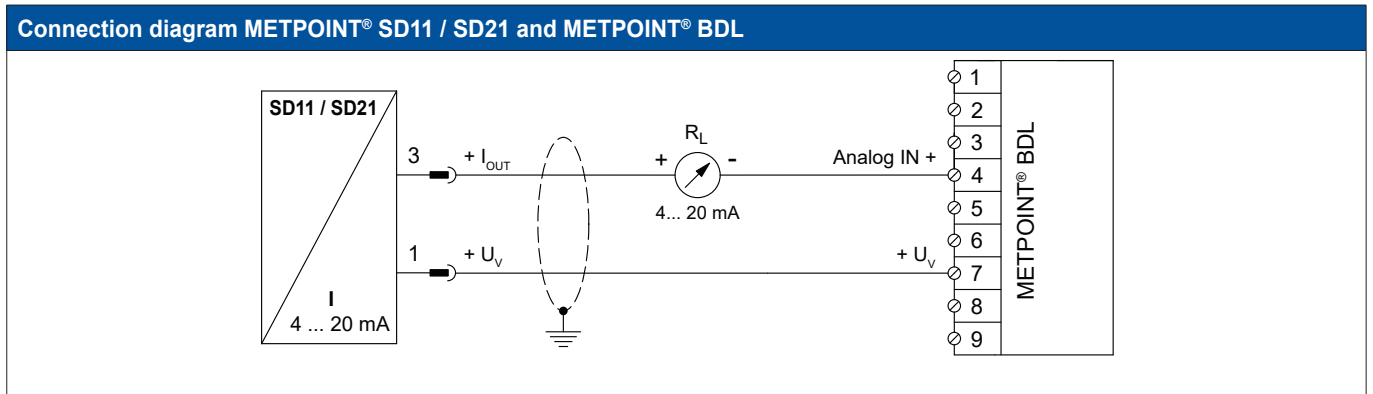

9.2.1.1. Analogue – 2-wire, 4 ... 20 mA



Pin assignment – sensor		Function	Wire colour	Pin assignment – BDL	
PIN-1	+ U _v	Plus (+) output, voltage supply	brown	PIN-7	+ U _v
PIN-3	+ I _{OUT}	Current output	blue	PIN-4	Analogue IN +
PIN-4		not assigned			
PIN-2		not assigned			

9.2.2. Connection of METPOINT® SD23

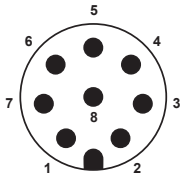
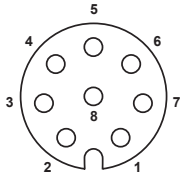
Pin assignment of plug-type connector, M12 x 1, 8-pin, A-coded

Pin assignment of connector Transmitter side	Pin assignment of connector Bush side view	Pin assignment of connector Screw side
		

9.2.2.1. Analogue – 4-wire, 4 ... 20 mA

Connection diagram for METPOINT® SD23 and METPOINT® BDL

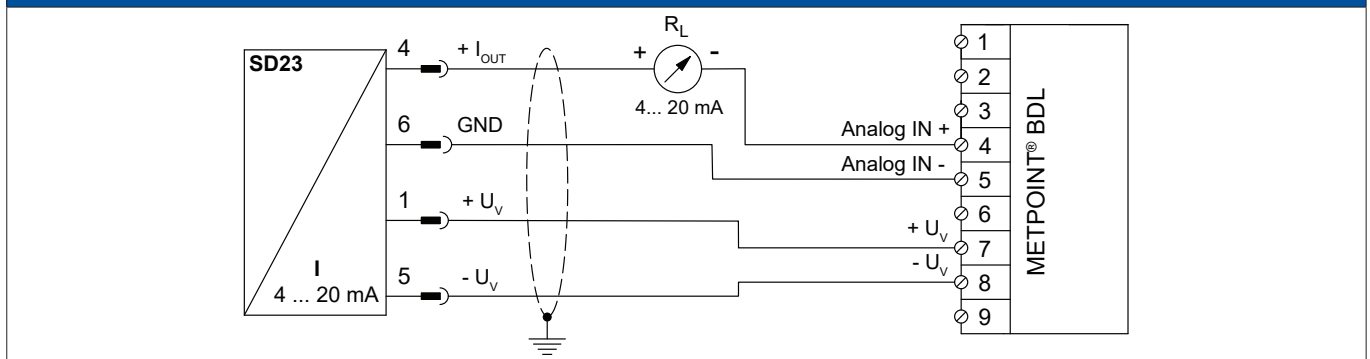

Pin assignment – sensor		Function	Wire colour	Pin assignment – BDL	
PIN-1	+ U _V	Plus (+) connection, voltage supply	brown	PIN-7	+ U _V
PIN-4	+ I _{OUT}	Current output	white	PIN-4	Analogue IN +
PIN-6	GND	Analogue reference potential	black	PIN-5	Analogue IN -
PIN-5	- U _V	Minus (-) connection, voltage supply	blue	PIN-8	- U _V
PIN-2		not assigned			
PIN-3		not assigned			
PIN-7		not assigned			
PIN-8		not assigned			

9.2.2.2. Analogue – 4-wire, 0 ... 10 V

Connection diagram for METPOINT® SD23 and METPOINT® BDL

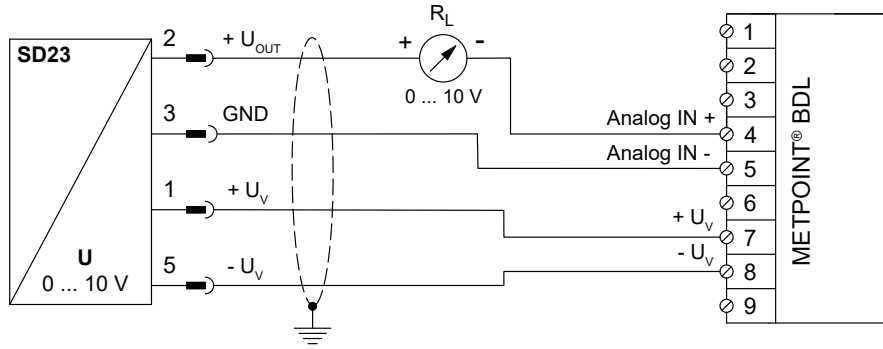

Pin assignment – sensor		Function	Wire colour	Pin assignment – BDL	
PIN-1	+ U _v	Plus (+) connection, voltage supply	brown	PIN-7	+ U _v
PIN-2	+ U _{OUT}	Plus (+) connection, measuring signal	white	PIN-4	Analogue IN +
PIN-3	GND	Analogue reference potential	black	PIN-5	Analogue IN -
PIN-5	- U _v	Minus (-) connection, voltage supply	blue	PIN-8	- U _v
PIN-4		not assigned			
PIN-6		not assigned			
PIN-7		not assigned			
PIN-8		not assigned			

9.2.2.3. Digital – bidirectional RS485 bus system

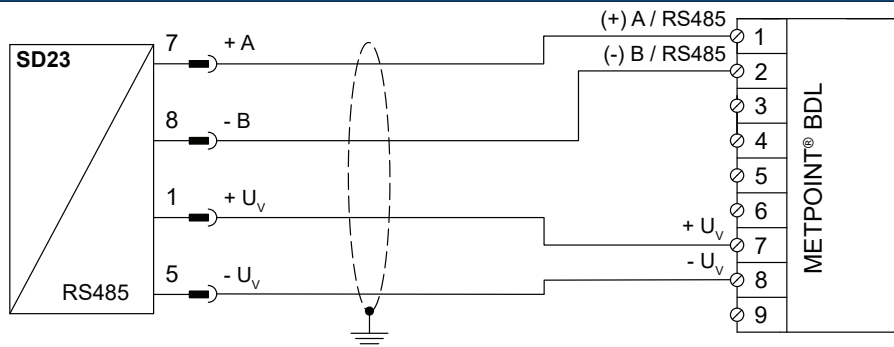

Connection diagram for METPOINT® SD23 and METPOINT® BDL



Pin assignment – sensor		Function	Wire colour	Pin assignment – BDL	
PIN-1	+ U _v	Plus (+) connection, voltage supply	brown	PIN-7	+ U _v
PIN-7	Bus A (+)	Non-inverted signal (+) from RS485 interface	white	PIN-1	(+) A / RS485
PIN-8	Bus B (-)	Inverted signal (-) from RS485 interface	black	PIN-2	(-) B / RS485
PIN-5	- U _v	Minus (-) connection, voltage supply	blue	PIN-8	- U _v
PIN-2		not assigned			
PIN-3		not assigned			
PIN-4		not assigned			
PIN-6		not assigned			

9.2.3. Connection of METPOINT® SP11 / SP21 / SP61

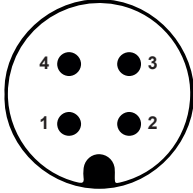
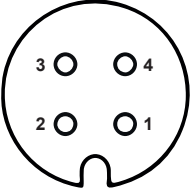
Pin assignment of plug-type connector, M12 x 1, 4-pin, A-coded

Pin assignment of connector Transmitter side	Pin assignment of connector Bush side view	Pin assignment of connector Screw side
		

9.2.3.1. Analogue – 2-wire, 4 ... 20 mA

Connection diagram METPOINT® SP11 / SP21 / SP61 and METPOINT® BDL

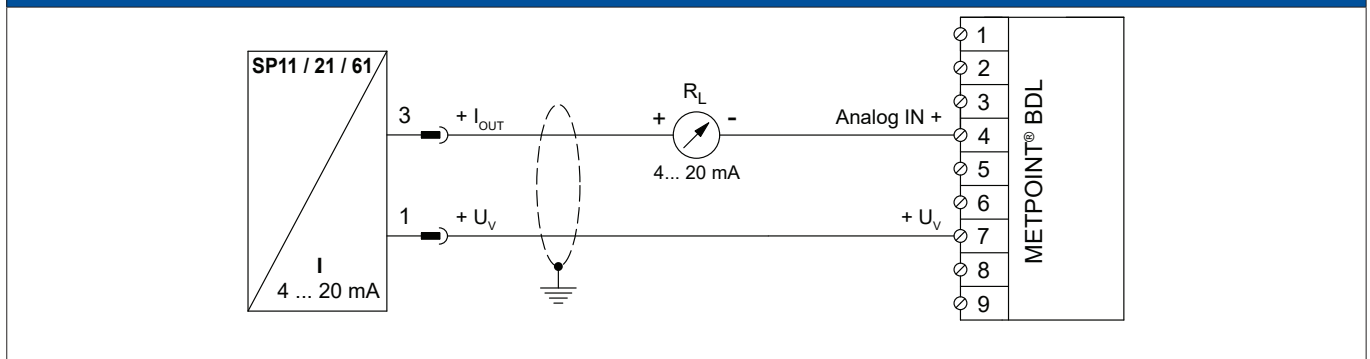

Pin assignment – sensor		Function	Wire colour	Pin assignment – BDL	
PIN-1	+ U _v	Plus (+) connection, supply voltage	brown	PIN-7	+ U _v
PIN-3	+ I _{OUT}	Current output	blue	PIN-4	Analogue IN +
PIN-4		not assigned			
PIN-2		not assigned			

9.2.4. Connection of METPOINT® SP22 / SP62

Pin assignment of plug-type connector, M12 x 1, 4-pin, A-coded

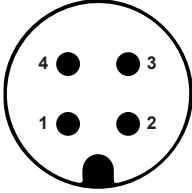
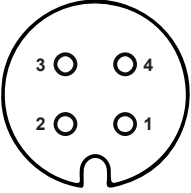
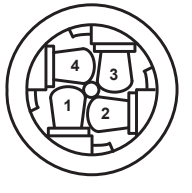
Pin assignment of connector Transmitter side	Pin assignment of connector Bush side view	Pin assignment of connector Screw side
		

9.2.4.1. Analogue – 4-wire, 0 ... 10 V

Connection diagram METPOINT® SP22 / SP62 and METPOINT® BDL

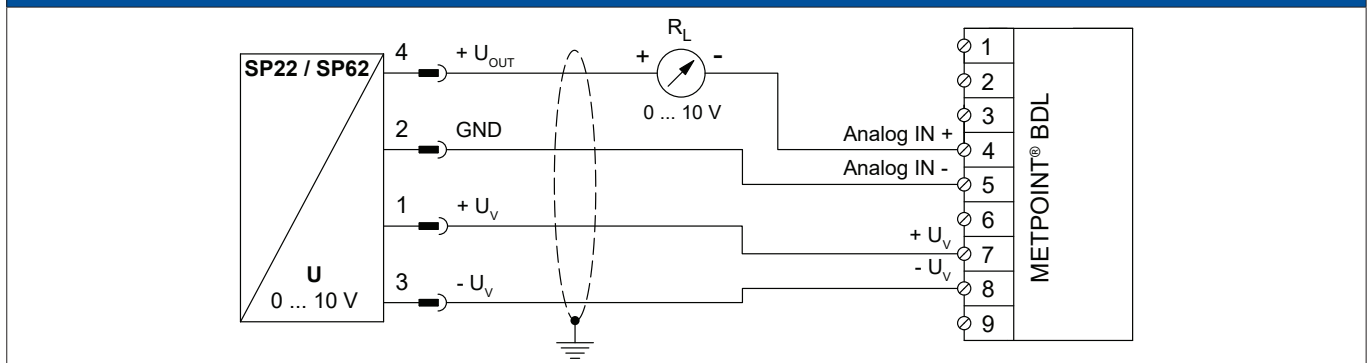

Pin assignment – sensor		Function	Wire colour	Pin assignment – BDL	
PIN-1	+ U _V	Plus (+) connection, voltage supply	brown	PIN-7	+ U _V
PIN-4	+ U _{OUT}	Plus (+) connection, measuring signal	white	PIN-4	Analogue IN +
PIN-2	GND	Analogue reference potential	black	PIN-5	Analogue IN -
PIN-3	- U _V	Minus (-) connection, voltage supply	blue	PIN-8	- U _V

9.2.4.2. Analogue – 3-wire, 0 ... 10 V

Connection diagram METPOINT® SP22 / SP62 and METPOINT® BDL

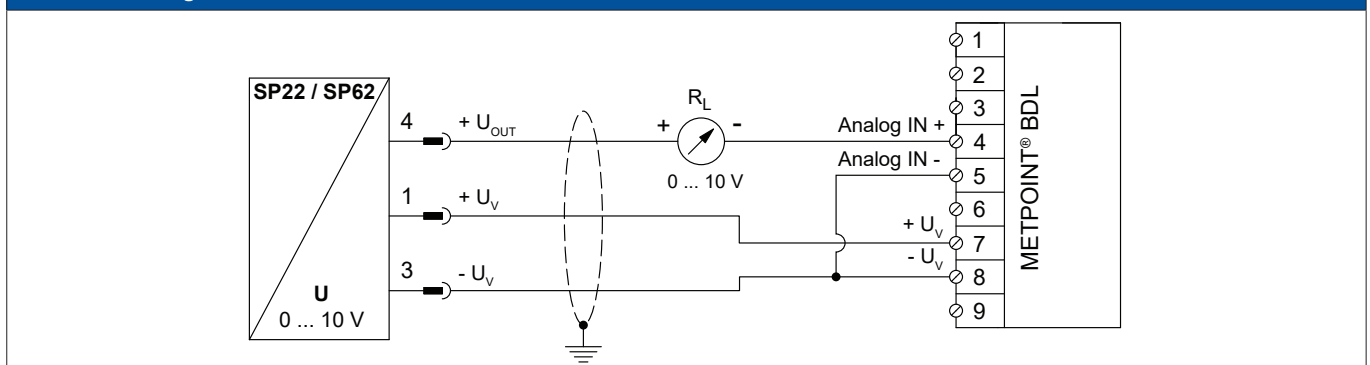

Pin assignment – sensor		Function	Wire colour	Pin assignment – BDL	
PIN-1	+ U _V	Plus (+) connection, voltage supply	brown	PIN-7	+ U _V
PIN-4	+ U _{OUT}	Plus (+) connection, measuring signal	white	PIN-4	Analogue IN +
PIN-2		not assigned			
PIN-3	- U _V	Minus (-) connection, voltage supply	blue	PIN-8	- U _V

9.2.5. Connection of SF13 / SF53

Pin assignment of plug-type connector A, M12 x 1, 5-pin, A-coded (according to EN 61076-2-101)

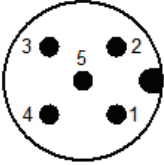
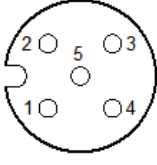
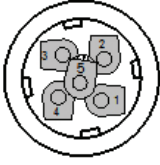
Pin assignment of connector Transmitter side	Pin assignment of connector Bush side view	Pin assignment of connector Screw side
		

Pin assignment of plug-type connector B, M12 x 1, 5-pin, A-coded (according to EN 61076-2-101)

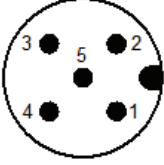
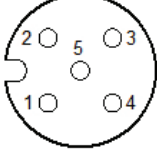
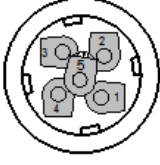
Pin assignment of connector Transmitter side	Pin assignment of connector Bush side view	Pin assignment of connector Screw side
		

9.2.5.1. Digital – bidirectional RS485 bus system

Connection by means of plug-type connector A.

Connection diagram METPOINT® SF13 / SF53 and METPOINT® BDL

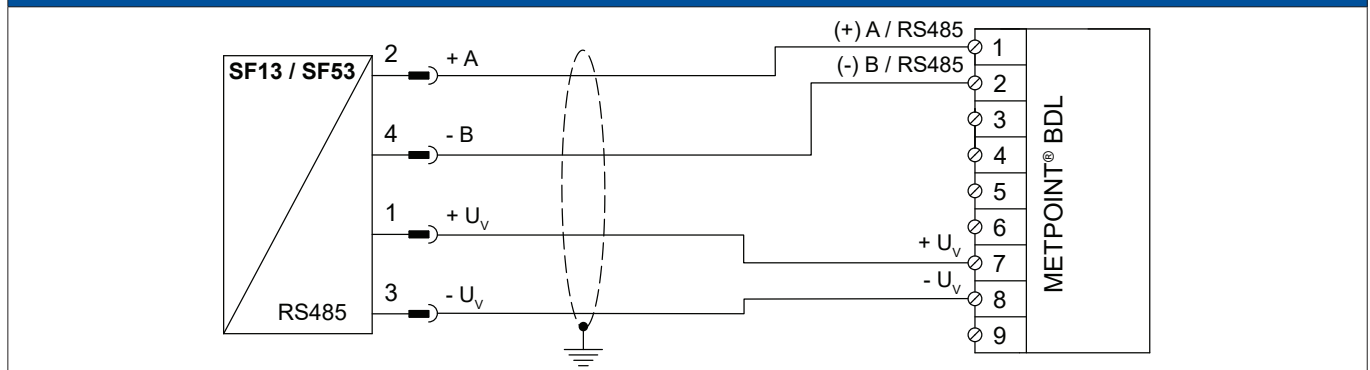

Pin assignment – sensor		Function	Wire colour	Pin assignment – BDL	
PIN-1	+ U _v	Plus (+) connection, voltage supply	brown	PIN-7	+ U _v
PIN-2	Bus A (+)	Non-inverted signal (+) from RS485 interface	white	PIN-1	(+) A / RS485
PIN-4	Bus B (-)	Inverted signal (-) from RS485 interface	black	PIN-2	(-) B / RS485
PIN-3	- U _v	Minus (-) connection, voltage supply	blue	PIN-8	- U _v
PIN-5		not assigned			

9.2.5.2. Analogue – 3-wire, 4 ... 20 mA

Connection by means of plug-type connector A.

Connection diagram METPOINT® SF13 / SF53 and METPOINT® BDL

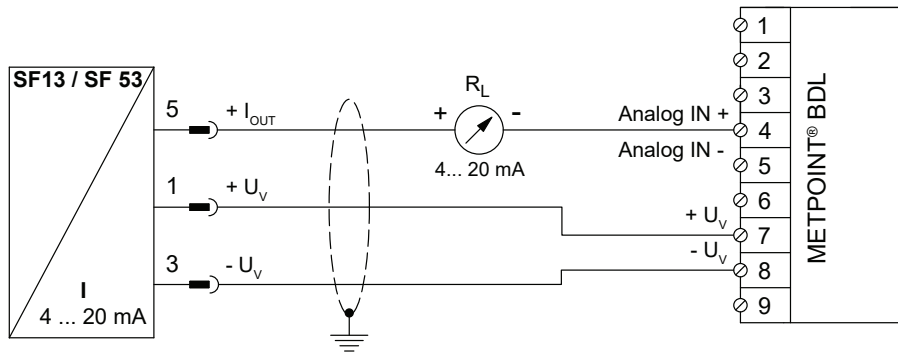

Pin assignment – sensor		Function	Wire colour	Pin assignment – BDL	
PIN-1	+ U _v	Plus (+) connection, voltage supply	brown	PIN-7	+ U _v
PIN-5	+ I _{OUT}	Current output	grey	PIN-4	Analogue IN (+)
PIN-3	- U _v	Minus (-) connection, voltage supply	blue	PIN-8	- U _v
PIN-2		not assigned	white		
PIN-4		not assigned	black		

9.2.5.3. Analogue – galvanically isolated pulse output

Connection by means of plug-type connector B.

Connection diagram METPOINT® SF13 / SF53 and METPOINT® BDL

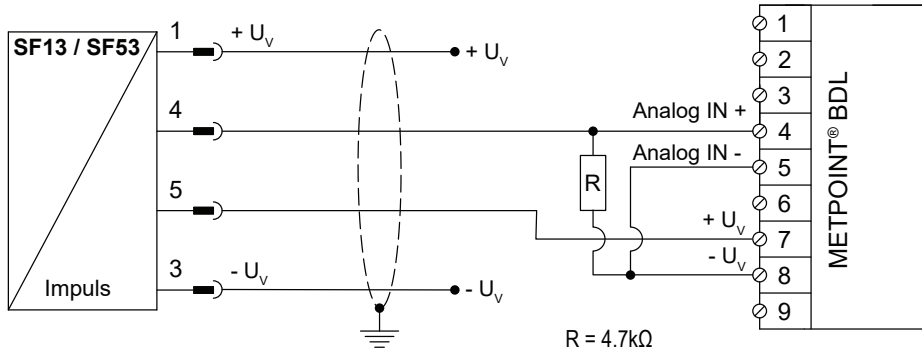

Pin assignment – sensor		Function	Wire colour	Pin assignment – BDL	
PIN-1	+ U _v	not assigned	brown		
PIN-4	Pulse	Pulse	black	PIN-4	Analogue IN (+)
PIN-5	Pulse	Pulse	grey	PIN-7	+ U _v
PIN-3	- U _v	not assigned	blue		
PIN-2		not assigned	white		

9.2.6. Connection of METPOINT® FS109 / FS211

Pin assignment of plug-type connector, M12 x 1, 5-pin, A-coded

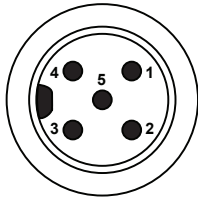
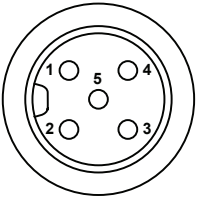
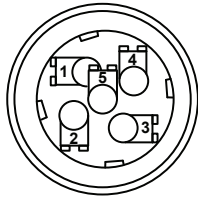
Pin assignment of connector Transmitter side	Pin assignment of connector Bush side view	Pin assignment of connector Screw side
		

9.2.6.1. Digital – SDI interface

Connection diagram METPOINT® FS109 / FS211 and METPOINT® BDL

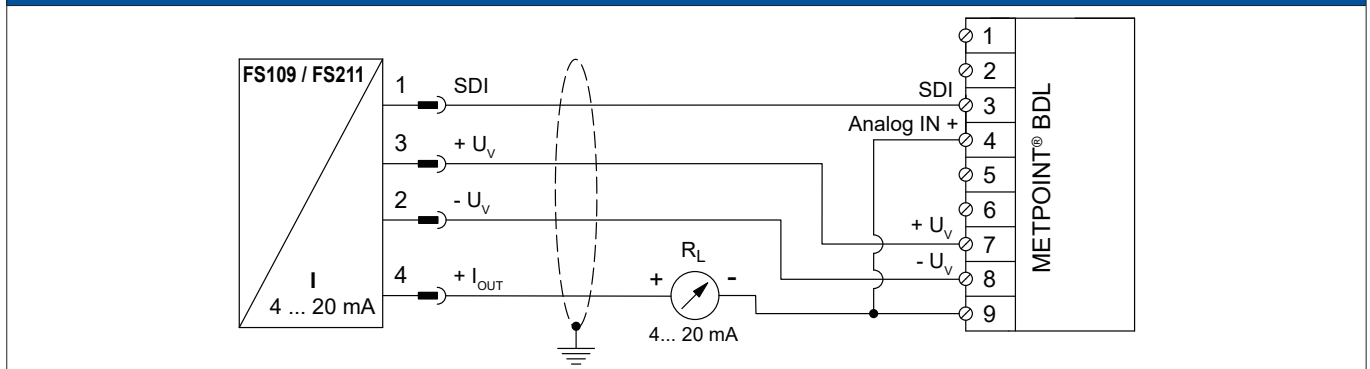

Pin assignment – sensor		Function	Wire colour	Pin assignment – BDL	
PIN-1	SDI	Digital interface	brown	PIN-3	SDI
PIN-3	+ U _v	Plus (+) connection, voltage supply	blue	PIN-7	+ U _v
PIN-2	- U _v	Minus (-) connection, voltage supply	white	PIN-8	- U _v
PIN-4	+ I _{OUT}	Current output	black	PIN-9	Ext. Display
PIN-5		not assigned			

9.2.7. Connection of OCV compact

9.2.7.1. Analogue – 2-wire, 4 ... 20 mA

Connection diagram METPOINT® OCV compact and METPOINT® BDL

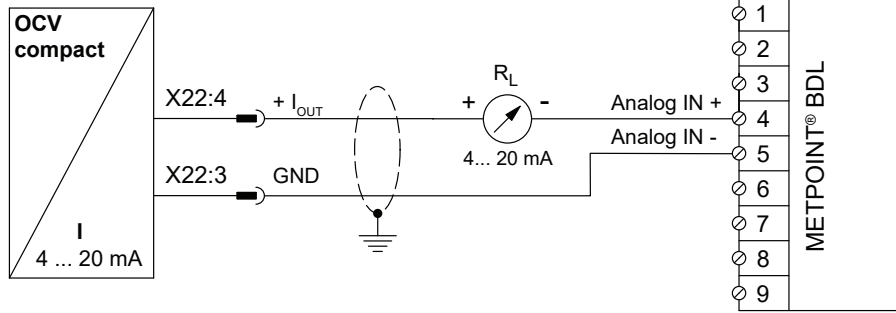

Assignment OCV compact		Function	Wire colour	Pin assignment – BDL	
X22:9		not assigned			
X22:8		not assigned			
X22:4	+ I _{OUT}	Current output	brown	PIN-4	Analogue IN (+)
X22:3	GND	Analogue reference potential	blue	PIN-5	Analogue IN (-)

9.2.7.2. Digital – bidirectional RS485 bus system

Connection diagram METPOINT® OCV compact and METPOINT® BDL

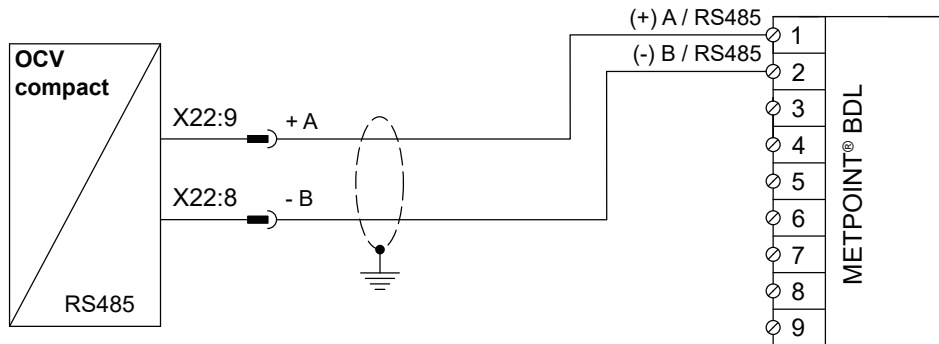

Assignment OCV compact		Function	Wire colour	Pin assignment – BDL	
X22:9	Bus A (+)	Non-inverted signal (+) from RS485 interface	brown	PIN-1	(+) A / RS485
X22:8	Bus B (-)	Inverted signal (-) from RS485 interface	blue	PIN-2	(-) B / RS485
X22:4		not assigned			
X22:3		not assigned			

9.2.8. Connection of PC 400

9.2.8.1. Digital – bidirectional RS485 bus system

Connection diagram PC 400 and METPOINT® BDL

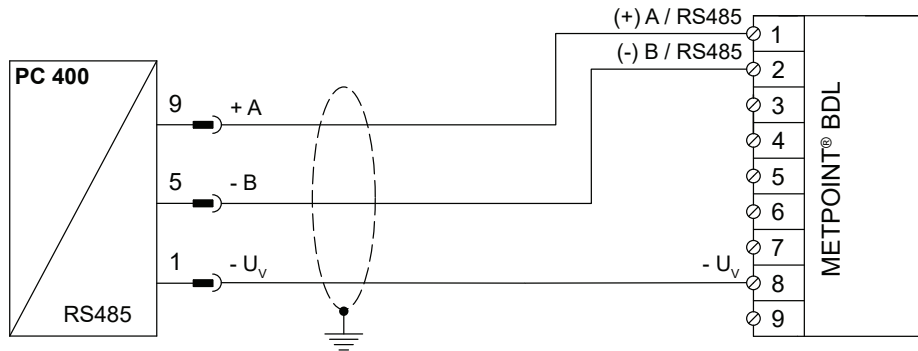

Pin assignment – sensor		Function	Wire colour	Pin assignment – BDL	
PIN-1	- U _v	Minus (-) connection, voltage supply	blue	PIN-8	- U _v
PIN-9	Bus A (+)	Non-inverted signal (+) from RS485 interface	white	PIN-1	(+) A / RS485
PIN-5	Bus B (-)	Inverted signal (-) from RS485 interface	black	PIN-2	(-) B / RS485
PIN-6		not assigned			
PIN-7		not assigned			
PIN-8		not assigned			
PIN-2		not assigned			
PIN-3		not assigned			
PIN-4		not assigned			

9.2.9. Connection of PT 1000

9.2.9.1. Analogue – 4-wire, 0 ... 10 V

Connection diagram PT 1000 and METPOINT® BDL

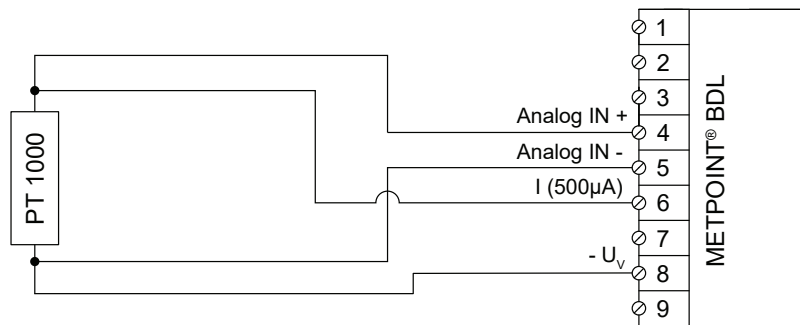

Pin assignment – sensor		Function	Wire colour	Pin assignment – BDL	
-	-	Power source 500 µA	red	PIN-6	I (500µA)
-	-	Plus (+) connection, measuring signal	white	PIN-4	Analogue IN +
-	-	Analogue reference potential	red	PIN-5	Analogue IN -
-	-	Minus (-) connection, voltage supply	white	PIN-8	- U _v

9.3. Connection of further sensors

Further analogue and digital sensors can be connected to the METPOINT® BDL. The different connection options are shown sorted according to how the measuring signals are transmitted.

9.3.1. Analogue – 0/4 ... 20 mA

9.3.1.1. Analogue – 2-wire 0/4 ... 20 mA

Connection diagram analogue 2-wire, 0/4... 20 mA

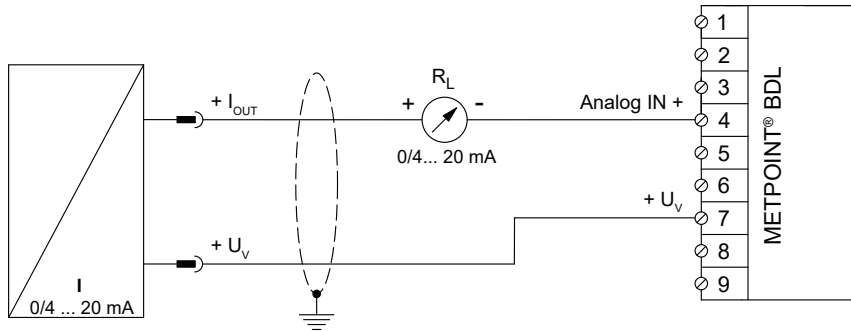

Pin assignment – sensor	Function	Pin assignment – BDL	
+ U _V	Plus (+) output, voltage supply	PIN-7	+ U _V
+ I _{OUT}	Current output	PIN-4	Analogue IN +

9.3.1.2. Analogue – 3-wire 0/4 ... 20 mA

Connection diagram analogue 3-wire, 0/4... 20 mA

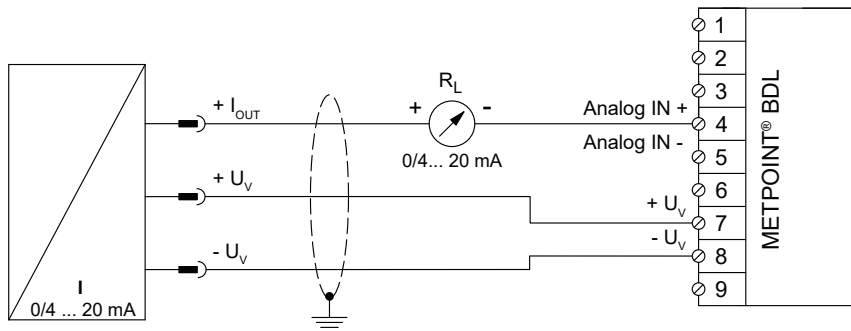

Pin assignment – sensor	Function	Pin assignment – BDL	
+ U _V	Plus (+) output, voltage supply	PIN-7	+ U _V
+ I _{OUT}	Current output	PIN-4	Analogue IN +
- U _V	Minus (-) connection, voltage supply	PIN-8	- U _V

9.3.1.3. Analogue – 4-wire 0/4 ... 20 mA

Connection diagram analogue 4-wire, 0/4... 20 mA

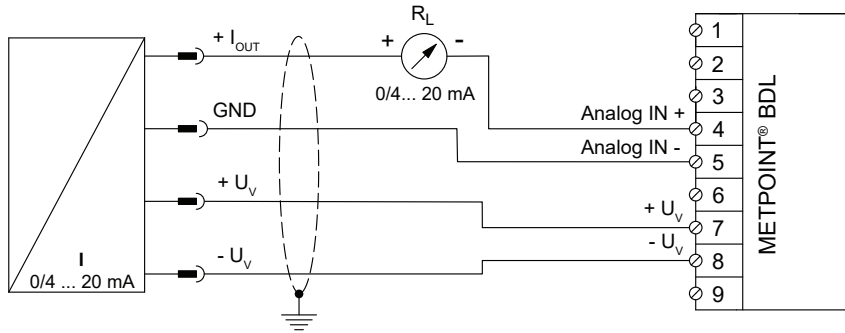

Pin assignment – sensor	Function	Pin assignment – BDL	
+ U _V	Plus (+) output, voltage supply	PIN-7	+ U _V
+ I _{OUT}	Current output	PIN-4	Analogue IN +
GND	Analogue reference potential	PIN-5	Analogue IN -
- U _V	Minus (-) connection, voltage supply	PIN-8	- U _V

9.3.2. Analogue – 0 ... 1/10/30 V

9.3.2.1. Analogue – 3-wire, 0 ... 1/10/30 V

Connection diagram analogue 3-wire, 0 ... 1/10/30 V

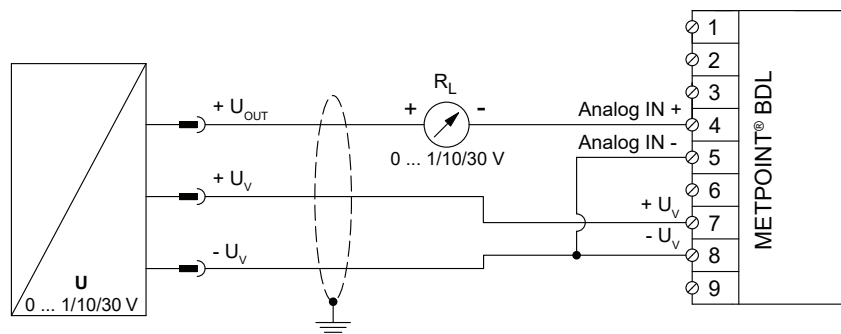

Pin assignment – sensor	Function	Pin assignment – BDL	
+ U _V	Plus (+) output, voltage supply	PIN-7	+ U _V
+ U _{out}	Plus (+) connection, measuring signal	PIN-4	Analogue IN +
- U _V	Minus (-) connection, voltage supply	PIN-8	- U _V

9.3.2.2. Analogue – 4-wire, 0 ... 1/10/30 V

Connection diagram analogue 4-wire, 0 ... 1/10/30 V

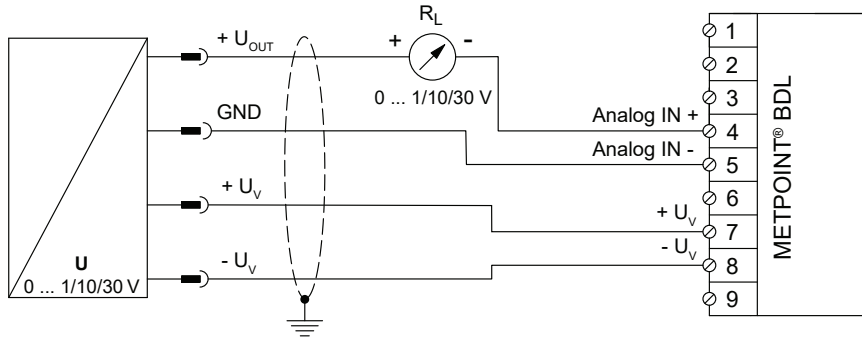

Pin assignment – sensor	Function	Pin assignment – BDL	
+ U _V	Plus (+) output, voltage supply	PIN-7	+ U _V
+ U _{out}	Plus (+) connection, measuring signal	PIN-4	Analogue IN +
- U _V	Minus (-) connection, voltage supply	PIN-8	- U _V
- U _V	Minus (-) connection, voltage supply	PIN-8	- U _V

9.3.3. SDI interface

9.3.3.1. Digital – 3-wire SDI-interface

Connection diagram 3-wire SDI-interface

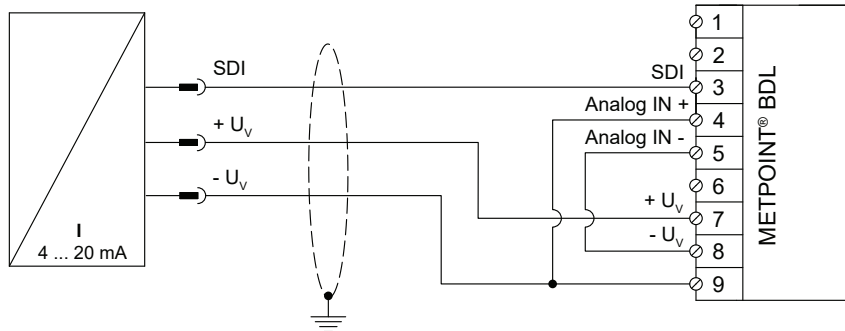

Pin assignment – sensor	Function	Pin assignment – BDL	
+ U _V	Plus (+) connection, voltage supply	PIN-7	+ U _V
SDI	Digital interface	PIN-3	SDI
- U _V	Minus (-) connection, voltage supply	PIN-9	Ext. Display

9.3.3.2. Digital – 4-wire SDI-interface

Connection diagram 4-wire SDI-interface

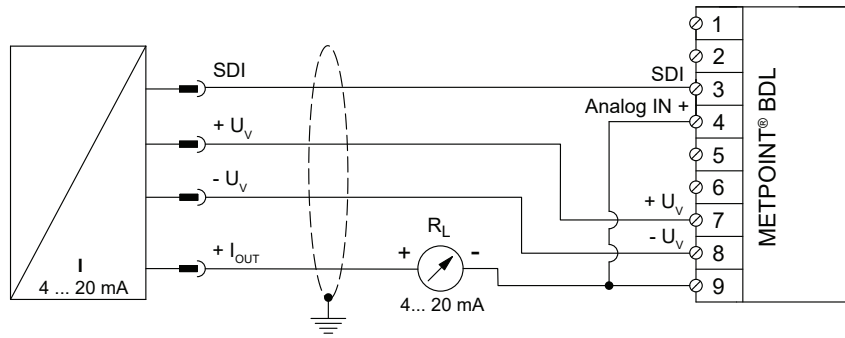

Pin assignment – sensor	Function	Pin assignment – BDL	
+ U _v	Plus (+) connection, voltage supply	PIN-7	+ U _v
SDI	Digital interface	PIN-3	SDI
- U _v	Minus (-) connection, voltage supply	PIN-8	- U _v
+ I _{OUT}	Current output	PIN-9	Ext. Display

9.3.4. Digital – bidirectional RS485 bus system

Connection diagram bidirectional RS485 bus system

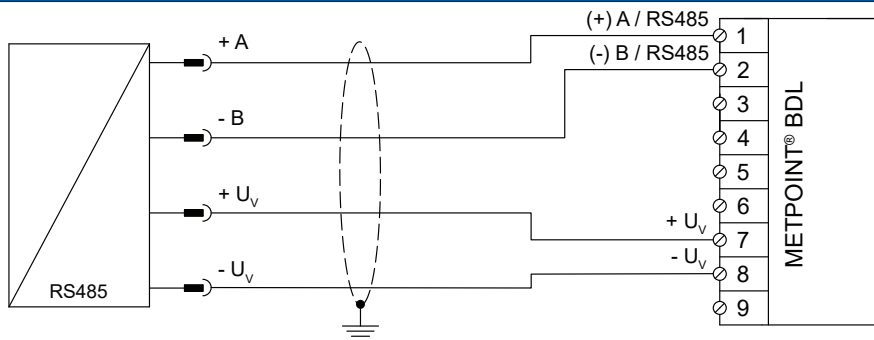

Pin assignment – sensor	Function	Pin assignment – BDL	
+ U _v	Plus (+) connection, voltage supply	PIN-7	+ U _v
Bus A (+)	Non-inverted signal (+) from RS485 interface	PIN-1	(+) A / RS485
Bus B (-)	Inverted signal (-) from RS485 interface	PIN-2	(-) B / RS485
- U _v	Minus (-) connection, voltage supply	PIN-8	- U _v

9.3.5. Analogue – galvanically isolated pulse sensors

Connection diagram pulse sensor

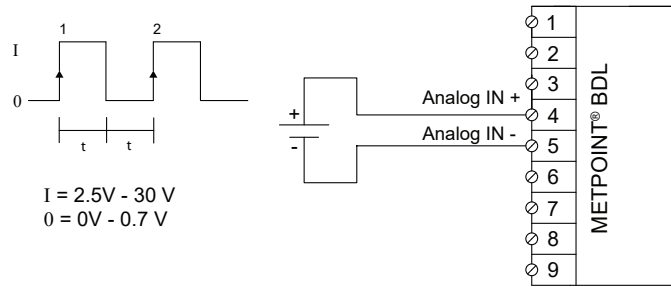

Pin assignment – sensor	Function	Pin assignment – BDL	
Pulse	Pulse	PIN-4	Analogue IN +
Pulse	Pulse	PIN-5	Analogue IN -

Connection diagram pulse sensor

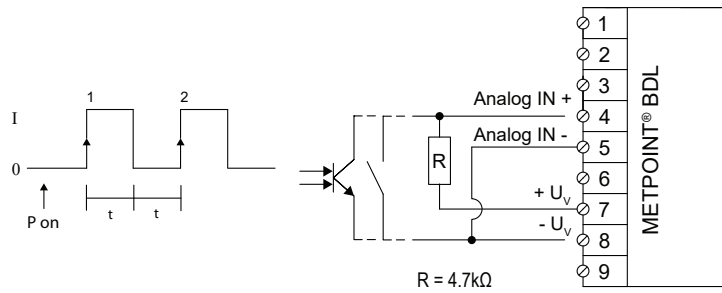

Pin assignment – sensor	Function	Pin assignment – BDL	
Pulse	Pulse	PIN-4	Analogue IN +
Pulse	Pulse	PIN-8	- U _v

Connection diagram pulse sensor

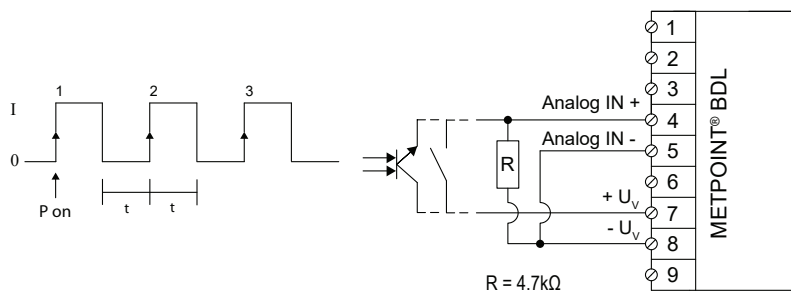

Pin assignment – sensor	Function	Pin assignment – BDL	
Pulse	Pulse	PIN-4	Analogue IN +
Pulse	Pulse	PIN-7	+ U _v

9.3.6. Resistance sensors

9.3.6.1. Analogue – 2-wire resistance sensors

Connection diagram 2-wire resistance sensors

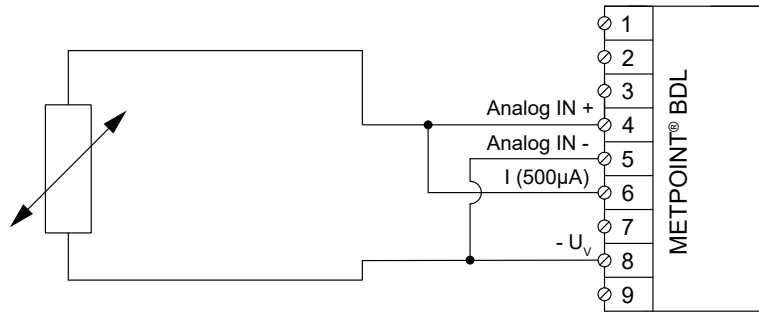

Pin assignment – sensor	Function	Pin assignment – BDL	
-	Plus (+) connection, measuring signal	PIN-4	Analogue IN +
-	Minus (-) connection, voltage supply	PIN-8	- U _v

9.3.6.2. Analogue – 3-wire resistance sensors

Connection diagram 3-wire resistance sensors

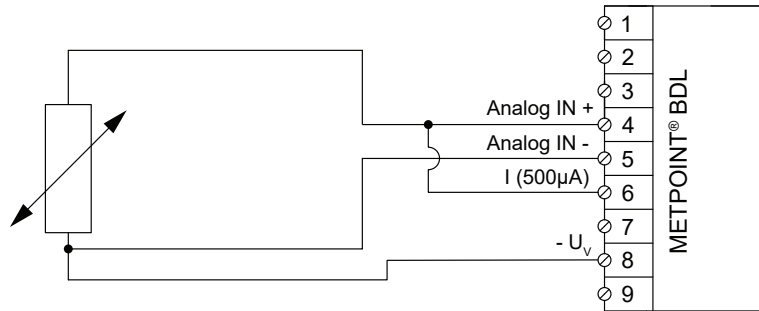

Pin assignment – sensor	Function	Pin assignment – BDL	
-	Plus (+) connection, measuring signal	PIN-4	Analogue IN +
-	Minus (-) connection of the measuring signal	PIN-5	Analogue IN -
-	Minus (-) connection, voltage supply	PIN-8	- U _v

9.3.6.3. Analogue – 4-wire resistance sensors

Connection diagram 4-wire resistance sensors

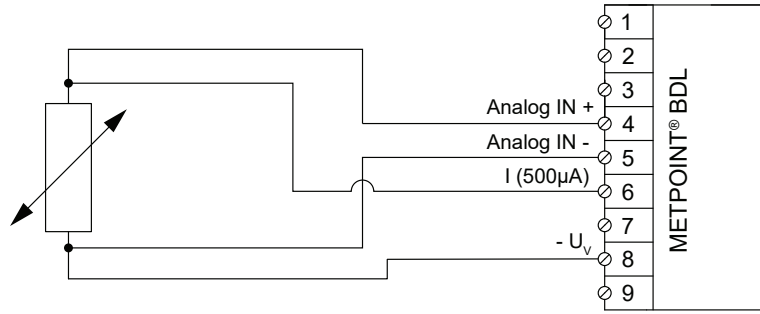

Pin assignment – sensor	Function	Pin assignment – BDL	
-	Plus (+) connection, measuring signal	PIN-4	Analogue IN +
-	Minus (-) connection of the measuring signal	PIN-5	Analogue IN -
-	Power source 500 µA	PIN-6	I (500 µA)
-	Minus (-) connection, voltage supply	PIN-8	- U _v

9.4. Connection of external displays (PLC / ZTL)

Power signals for an external PLC / ZTL or external display unit can be tapped at the METPOINT® BDL. The different connection options are shown sorted according to how the measuring signals are transmitted.

9.4.1. Analogue – 0/4 ... 20 mA

9.4.1.1. Analogue – 2-wire 0/4 ... 20 mA

Connection diagram analogue 2-wire, 0/4... 20 mA

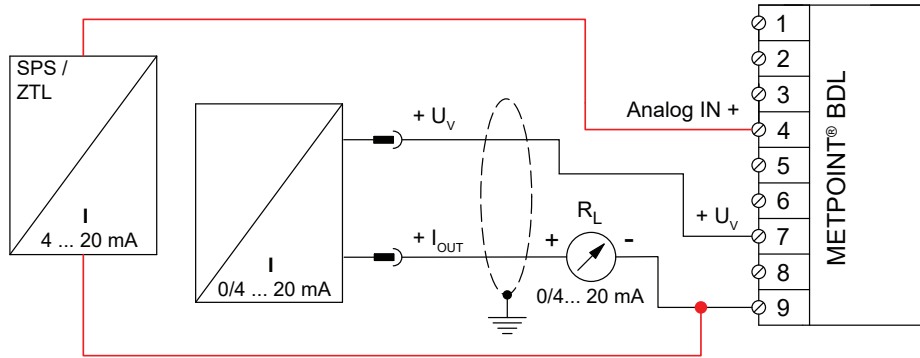

Pin assignment – sensor	Function	Pin assignment – BDL	
+ U _v	Plus (+) output, voltage supply	PIN-7	+ U _v
+ I _{OUT}	Current output	PIN-9	Ext. Display
-	Current input PLC / ZTL	PIN-9	Ext. Display
-	Current output PLC / ZTL	PIN-4	Analogue IN +

9.4.1.2. Analogue – 3-wire 0/4 ... 20 mA

Connection diagram analogue 3-wire, 0/4... 20 mA

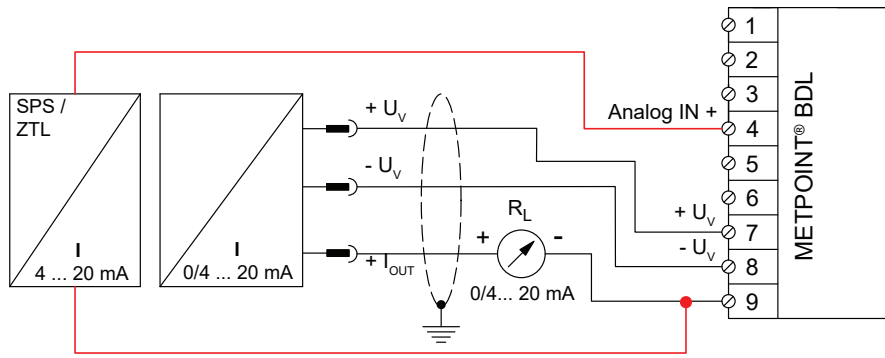

Pin assignment – sensor	Function	Pin assignment – BDL	
+ U _v	Plus (+) output, voltage supply	PIN-7	+ U _v
- U _v	Minus (-) connection, voltage supply	PIN-8	- U _v
+ I _{OUT}	Current output	PIN-9	Ext. Display
-	Current input PLC / ZTL	PIN-9	Ext. Display
-	Current output PLC / ZTL	PIN-4	Analogue IN +

9.4.1.3. Analogue – 4-wire 0/4 ... 20 mA

Connection diagram analogue 4-wire, 0/4... 20 mA

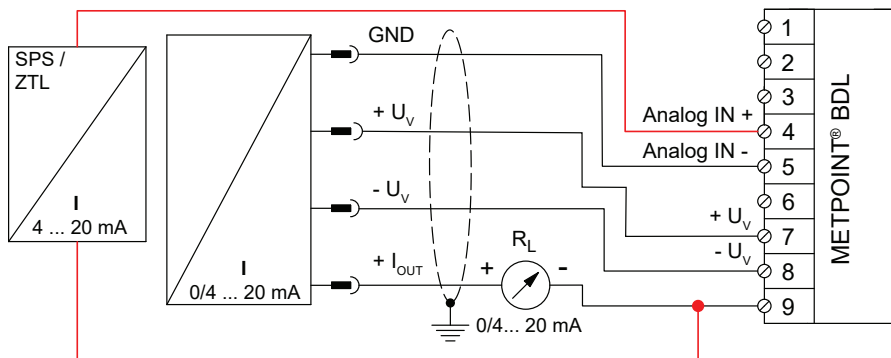

Pin assignment – sensor	Function	Pin assignment – BDL	
+ U _v	Plus (+) output, voltage supply	PIN-7	+ U _v
- U _v	Minus (-) connection, voltage supply	PIN-8	- U _v
GND	Analogue reference potential	PIN-5	Analogue IN -
+ I _{OUT}	Current output	PIN-9	Ext. Display
-	Current input PLC / ZTL	PIN-9	Ext. Display
-	Current output PLC / ZTL	PIN-4	Analogue IN +

9.4.2. SDI interface

9.4.2.1. Digital – 3-wire SDI-interface

Connection diagram 3-wire SDI-interface

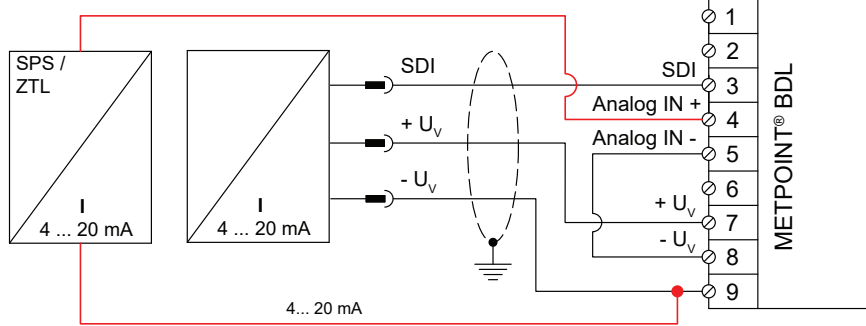

Pin assignment – sensor	Function	Pin assignment – BDL	
SDI	Digital interface	PIN-3	SDI
+ U _v	Plus (+) connection, voltage supply	PIN-7	+ U _v
- U _v	Minus (-) connection, voltage supply	PIN-9	Ext. Display
-	Current input PLC / ZTL	PIN-9	Ext. Display
-	Current output PLC / ZTL	PIN-4	Analogue IN +

9.4.2.2. Digital – 4-wire SDI-interface

Connection diagram 4-wire SDI-interface

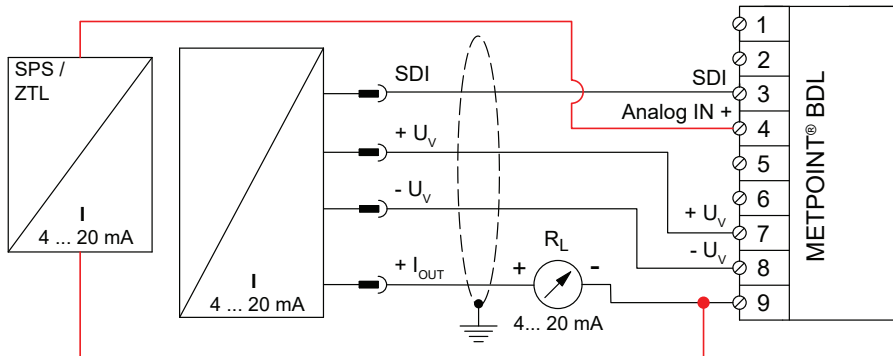

Pin assignment – sensor	Function	Pin assignment – BDL	
SDI	Digital interface	PIN-3	SDI
+ U _v	Plus (+) connection, voltage supply	PIN-7	+ U _v
- U _v	Minus (-) connection, voltage supply	PIN-8	- U _v
+ I _{OUT}	Current output	PIN-9	Ext. Display
-	Current input PLC / ZTL	PIN-9	Ext. Display
-	Current output PLC / ZTL	PIN-4	Analogue IN +

9.4.3. Digital – bidirectional RS485 bus system

Connection diagram bidirectional RS485 bus system

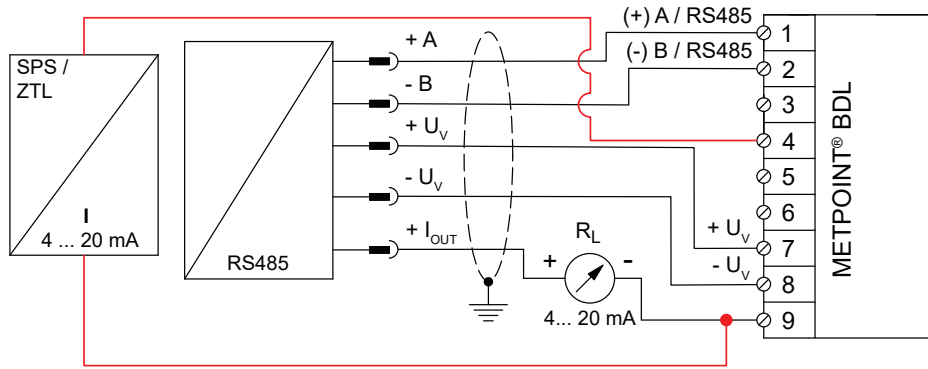

Pin assignment – sensor	Function	Pin assignment – BDL	
Bus A (+)	Non-inverted signal (+) from RS485 interface	PIN-1	(+) A / RS485
Bus B (-)	Inverted signal (-) from RS485 interface	PIN-2	(-) B / RS485
+ U _v	Plus (+) connection, voltage supply	PIN-7	+ U _v
- U _v	Minus (-) connection, voltage supply	PIN-8	- U _v
+ I _{OUT}	Current output	PIN-9	Ext. Display
-	Current input PLC / ZTL	PIN-9	Ext. Display
-	Current output PLC / ZTL	PIN-4	Analogue IN +

10. Connecting the BDL with a PC

Important:

The IP addresses of the PC and the BDL must be static (DHCP off) and part of the same network. If the IP address of the BDL has been changed, you must restart the device!

Notice:

IP address of BDL: see chapter 12.2.5.3 Network settings

Restarting BDL: see chapter 12.2.5.7 Reset to factory settings

To connect the BDL to a PC, use an 8-wire crossover cable with RJ45 plug-type connectors at both ends. Alternatively use an Ethernet cable with a crossover adapter.



Crossover cable with RJ45 plug-type connectors



Crossover adapter

After the BDL has been connected to the PC, you can use the METPOINT® READER SW201 software for the evaluation of data in the form of charts and tables.

Network settings for Windows PC:

Windows 7:

Start ► Control Panel ► Network and Sharing Center ► Change adapter settings ► LAN Connection ► Properties ► Internet Protocol Version 4 (TCP/IPv4) ► Use the following IP address ►

Enter the IP address and subnet mask

Then: OK ► OK ► Close

Windows Vista:

Start ► Control Panel ► Network and Sharing Center ► Manage network connections ► LAN Connection ► Properties ► Internet Protocol Version 4 (TCP/IPv4) ► Use the following IP address ►

Enter the IP address and subnet mask

Then: OK ► OK ► Close

Windows XP:

Start ► Settings ► Control Panel ► Network Connection ► LAN Connection ► Properties ►

Internet Protocol (TCP/IP) ► Use the following IP address ► Enter the IP address and subnet mask.

Then: OK ► OK ► Close

11. SD card and battery

To store measuring results for subsequent processing, the BDL features an SD card slot.

An integrated battery (button cell) ensures that the configuration data of the METPOINT® BDL is not lost when the device is shut down.

Danger!	Battery and SD card!
	The battery and the SD card must be changed by authorised skilled technical personnel. Before changing the battery or SD card, ensure that the device is de-energised.

Danger!	Risk of damage from ESD
	The device contains electronic components that might be damaged or even destroyed by electrostatic discharge (ESD).

Preventive measures

For maintenance and service work that requires you to open the housing of the device, observe the instructions in chapter 8.1.1 to prevent damage from electrostatic discharge.

Use only SD cards and batteries that meet the following specifications:

SD card	
Card size/type:	SD card
Max. capacity:	4 GB
File system:	FAT32
Dimensions:	32 x 24 x 2.1 mm

Battery	
Battery type:	CR2032 button cell
Capacity:	170 mAh
Dimensions:	20 x 3.2 mm
Voltage:	3 V
System	Lithium

11.1. Battery replacement

1. Unscrew the screws of the housing cover and open the cover
2. Carefully remove the existing battery
3. Insert the new battery – for position, see diagram
4. Mount the cover and tighten the screws

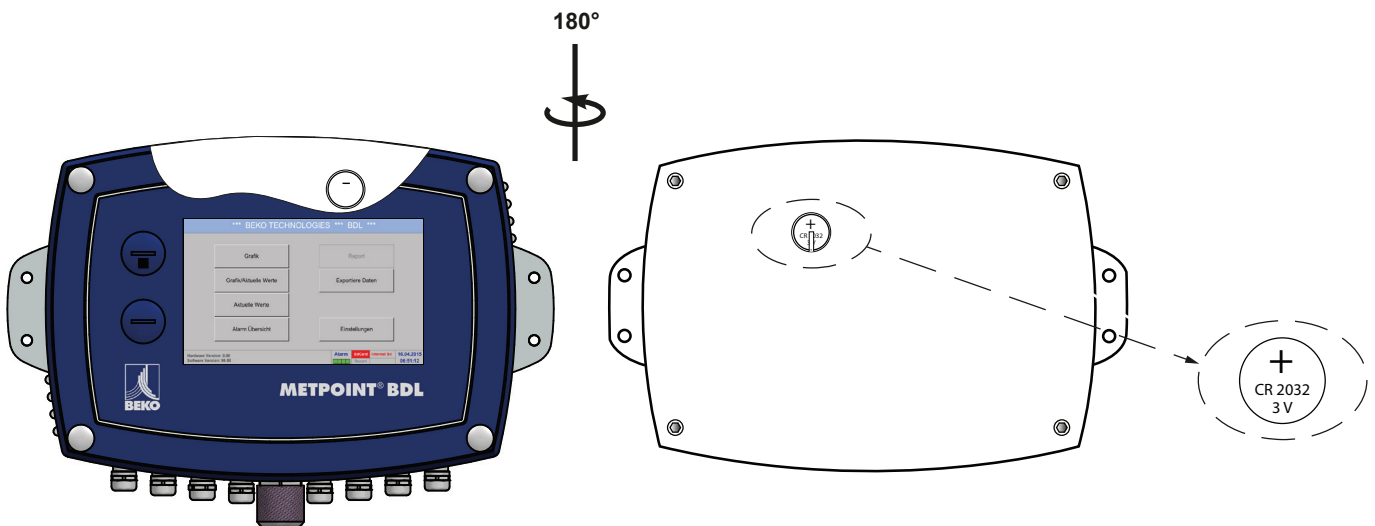

11.2. SD card replacement

1. Unscrew and remove the screw plug [1]
2. Slightly press down the installed SD card and remove it from the SD card slot
3. Insert the new SD card into the SD card slot until it engages
4. Reinstall and tighten the screw plug [1]

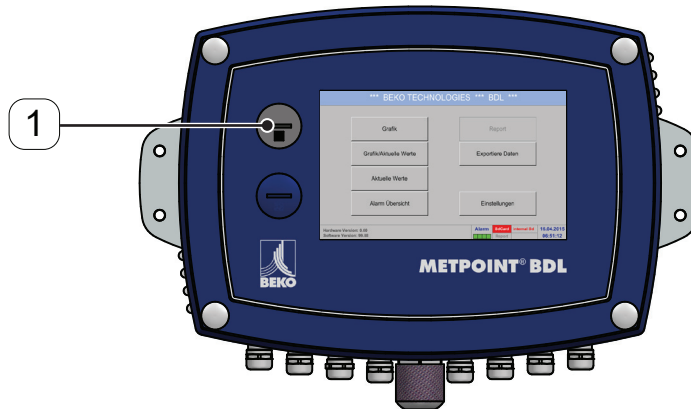

12. Operation of BDL

The BDL is operated through a menu-driven, intuitive touch screen. To select a menu option, touch it lightly with your finger or a soft-pointed pen.

Caution:

Do not use normal pens or pointed implements as these could damage the foil!

After the sensors have been connected, they must be configured.

Entries or changes can be made in the white fields. The measured values are displayed as values or in the form of curves.

Text in **green letters** refers mainly to figures in the respective chapter. Important menus and menu options are also shown with **green letters**.

The menu navigation is generally shown in **green letters**!

12.1. Main menu (home)

From the main menu, you can access all available submenus.

12.1.1. Initialisation



After the BDL has been switched on, all channels are initialised and the main menu is displayed.

Caution:

At the first start-up, there might be no preset channels.

Configure the individual sensors. The relevant information is compiled in chapter 12.2.2.

12.1.2. Main menu after switching-on

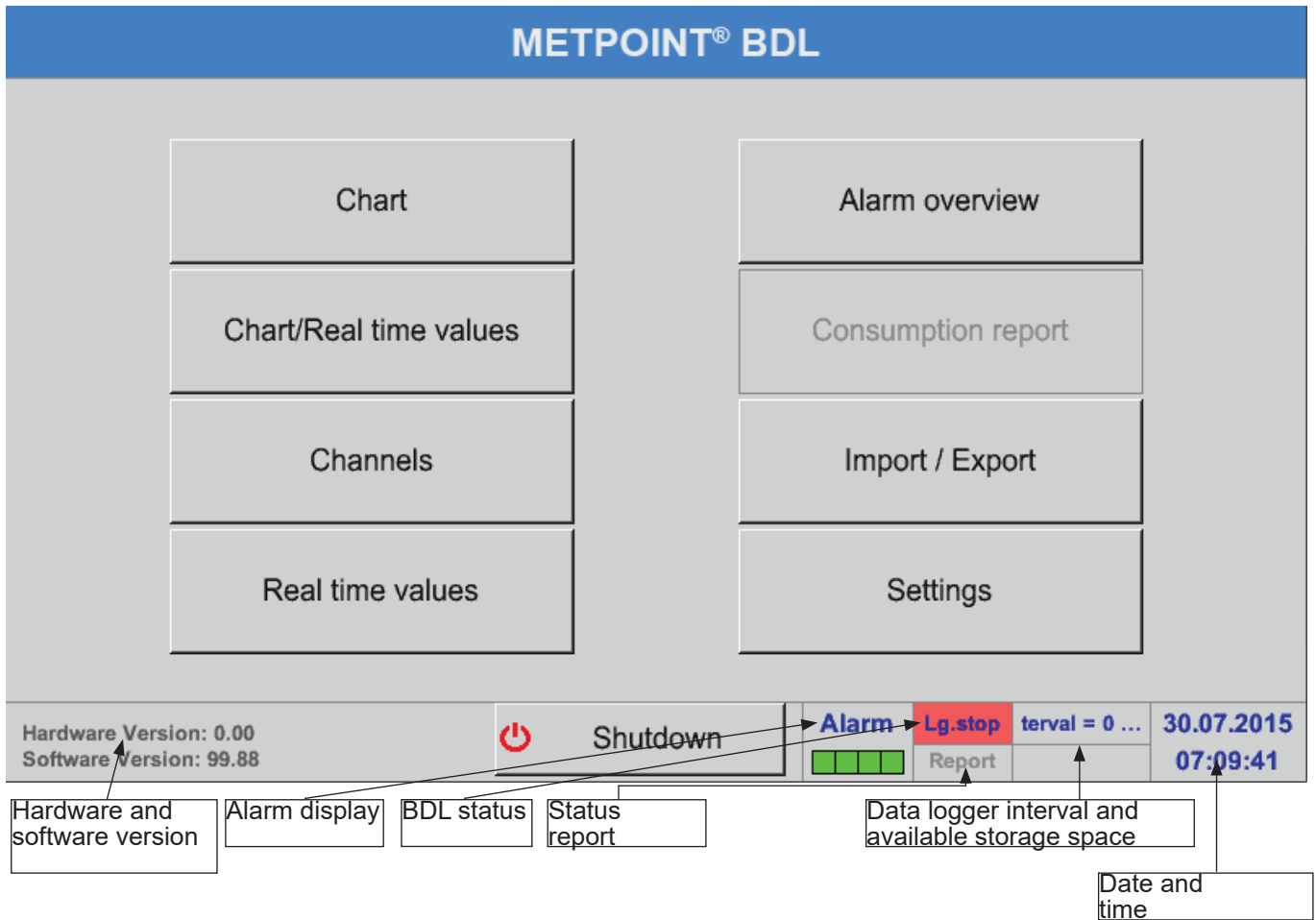

Important:

Before entering the sensor settings, select the language and set the time.

Notice:

Chapter „12.2.5.1. Language“, page 71

(English menu navigation: [Main](#) ► [Settings](#) ► [Device Settings](#) ► [Set Language](#))

Chapter „12.2.5.2. Date & time“, page 71

(English menu navigation: [Main](#) ► [Settings](#) ► [Device Settings](#) ► [Date & Time](#))

12.2. Settings

All settings are password-protected!
Settings or changes must always be confirmed with **OK!**

Notice:

When returning to the main menu and then calling up the settings menu again, you must once more enter the password!

Main menu ► Settings

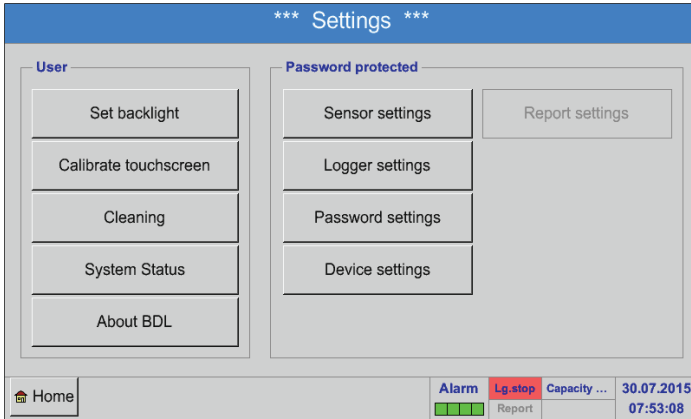

Overview of Settings

The optional **Report settings** and the related **Costs** can be found in chapters 12.2.6 Report settings (optional) and 12.8.2 Costs (optional). To view the result tables, select menu option 12.8.1 Report/consumption analysis (optional).

12.2.1. Password

Main menu ► Settings ► Password-setting



Default password (factory settings): 4321

If required, change the password under: **Password.**

Enter the new password twice and confirm with **OK.**



If the two password entries do not match, message **Enter password** or **Confirm new password** is displayed in red.

If you have forgotten your password, enter the master password and then a new password.

The master password can be requested from BEKO Technologies GmbH, with the serial number of the METPOINT® BDL specified in the request.

12.2.2. Sensor settings

Important:

Sensors from BEKO TECHNOLOGIES GmbH are generally pre-configured and can be connected without further adjustments to a free sensor channel!

Main menu ► Settings ► Sensor settings

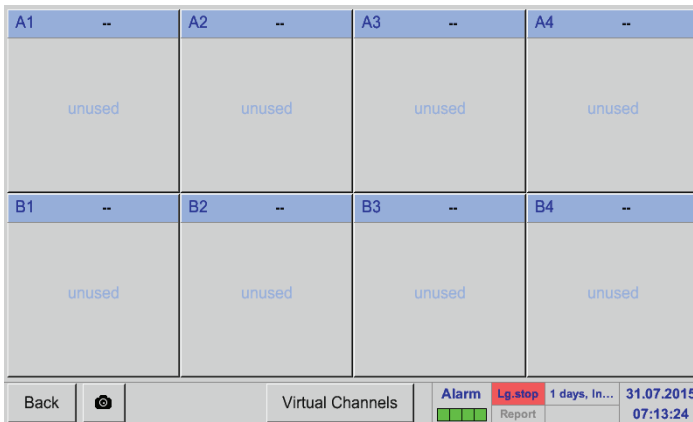

Enter the password. An overview of the available channels is displayed. Depending on your device mode, there are 4, 8, or 12 channels.

Note:
Normally, no channels are preset!

Note:

- | | | |
|--------------------------|---------------------|----------------------|
| BDL models and versions: | No extension board | ► 4 channels/setups |
| | One extension board | ► 8 channels/setups |
| | Two extension board | ► 12 channels/setups |

12.2.2.1. Selecting sensor type (example: BEKO Digital sensor)

Main menu ► Settings ► Sensor settings ► A1

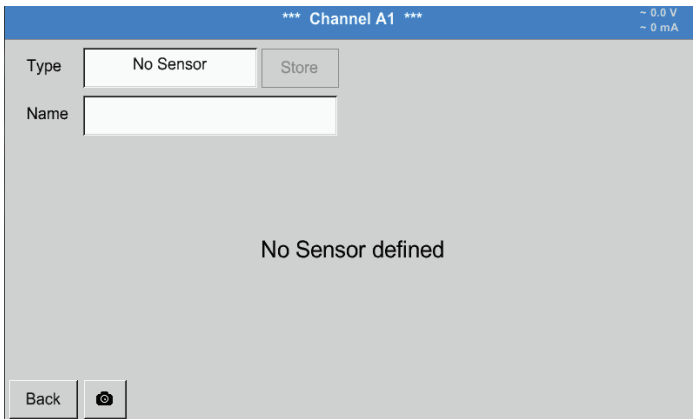

If no sensor has been configured yet, **No sensor** is displayed in the type field.

Touch the **No sensor** text field to call up a list of sensor types (see next step).

Main menu ► Settings ► Sensor settings ► A1 ► Type ► Digital

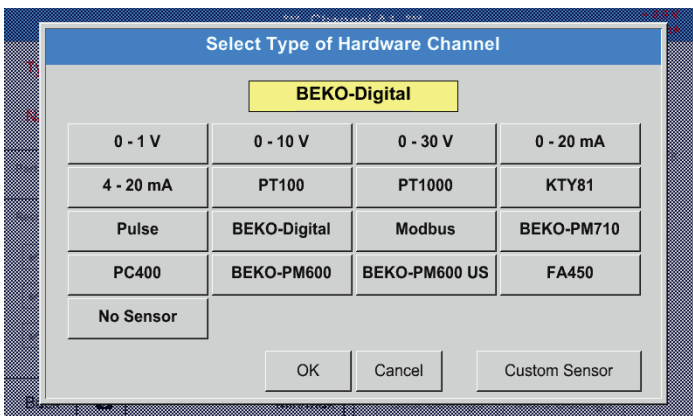

For FS/DP series sensors, select type **Digital** and confirm with **OK**.

Main menu ► Settings ► Sensor settings ► A1 ► Diameter

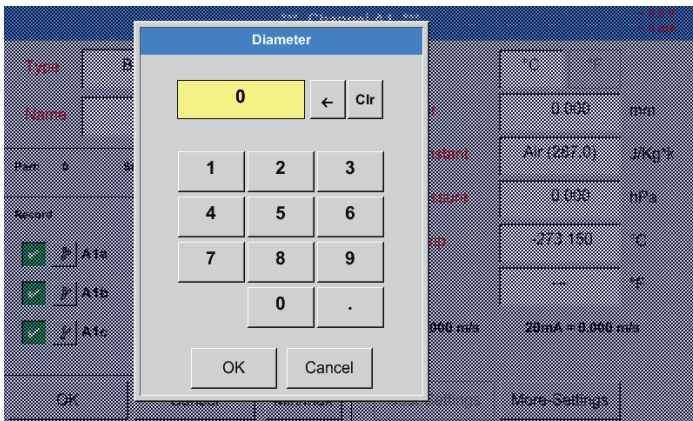

Important:

Unless it has been automatically set, enter the **Inside diameter** of the flow pipe.

Important:

The **Inside diameter** should be as exact as possible, as this parameter affects the accuracy of the measuring results!

There is no general standard for inside diameter of pipes! (Please ask the manufacturer or measure the pipe yourself!)

Main menu ► Settings ► Sensor settings ► A1

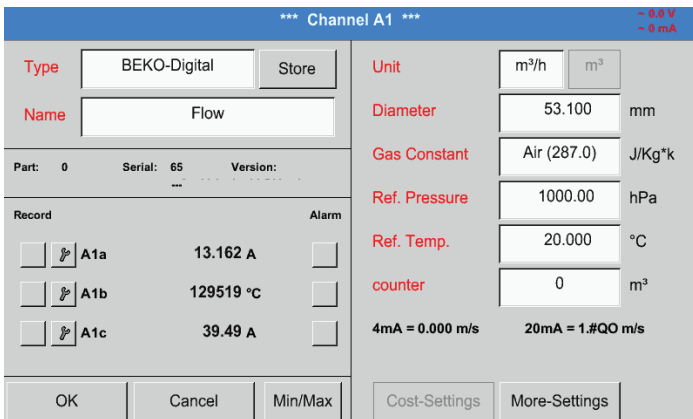

Enter the **Name** of the sensor. If the new sensor replaces another one, enter the **Counter** value of the previous sensor (optional).

Main menu ► Settings ► Sensor settings ► A1

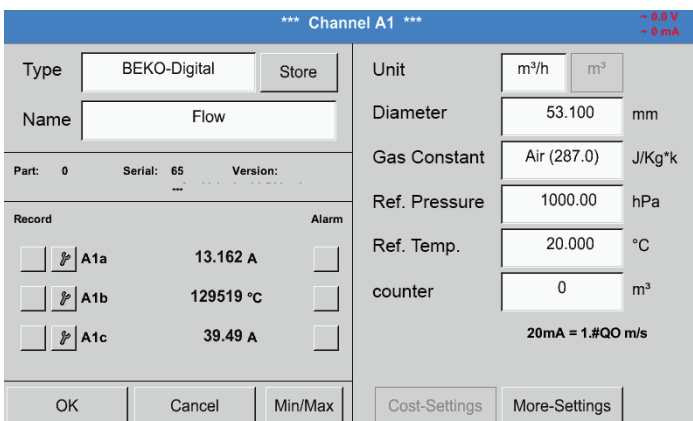

Confirm the changes with **OK**. The sensor configuration is now completed.

See also chapter 12.2.2.7 Labelling and configuring text fields

Note:

After confirming with **OK**, the field labels change to black. The values and settings are applied.

Caution:

Reference temperature and reference pressure (factory settings 20 °C, 1000 hPa):
 All volume flow (m³/h) and consumption (m³) values shown on the display refer to 20 °C and 1000 hPa (according to ISO 1217). Alternatively, enter 0 °C and 1013 hPa (=standard cubic metre according to DIN 1343) as the reference values. Do not enter the operating pressure or the operating temperature as the reference values!

12.2.2.2. Labelling measurements and defining resolution (decimals)

Note:

To configure the **Resolution** (decimal places), the **Short name** and the **Value name**, click the **Tool** button!

Tool button:



Main menu ► Settings ► Sensor settings ► A1

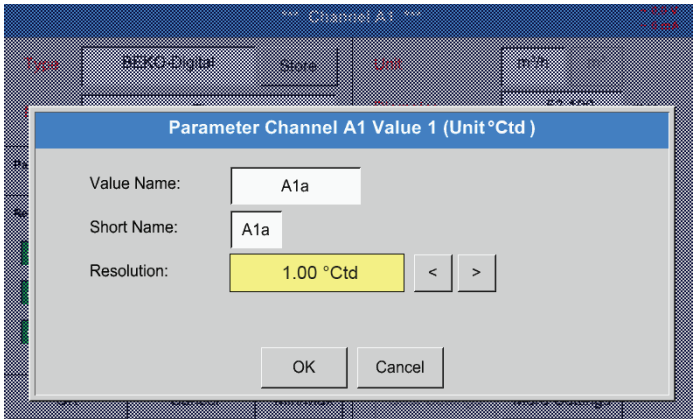

For the **Value** to be recorded, enter a **Name** with max. 10 characters. This name is then used in the **Charts** and **Chart/current values** menus. Otherwise, the default name (e.g. **A1a**) is displayed.

A1 indicates the channel; **a** is the first value in the channel, **b** would be the second, and **c** the third.

To adjust the **Resolution** of the decimal places, touch the arrow buttons (0 to 5 decimals places).

See also chapter 12.2.2.7 Labelling and configuring text fields

Important:

In the menus **Main menu ► Settings ► Sensor settings** and **Main menu ► Current values**, the **Value name** is only indicated at the BDL standard version with four channels!

The **Short name** is only used in the above two menu items and the BDL version with one or two extension boards (8 or 12 channels).

12.2.2.3. Recording measuring data

Main menu ► Settings ► Sensor settings ► A1 ► Record button

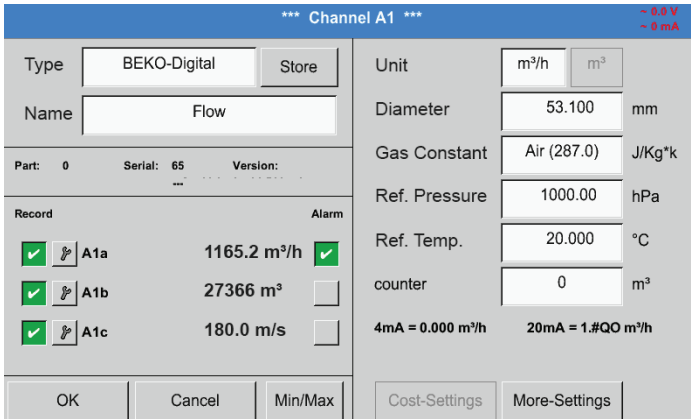

Press the **Record** buttons to select the measurements to be recorded and stored on the **activated data logger**.

Caution:

Prior to recording the selected measuring data, configure the data logger and then start it (see chapter 12.2.4 Logger settings (data logger)).

12.2.2.4. Alarm settings

Main menu ► Settings ► Sensor settings ► A1 ► Alarm button

Pressing an Alarm button to call up the following window:

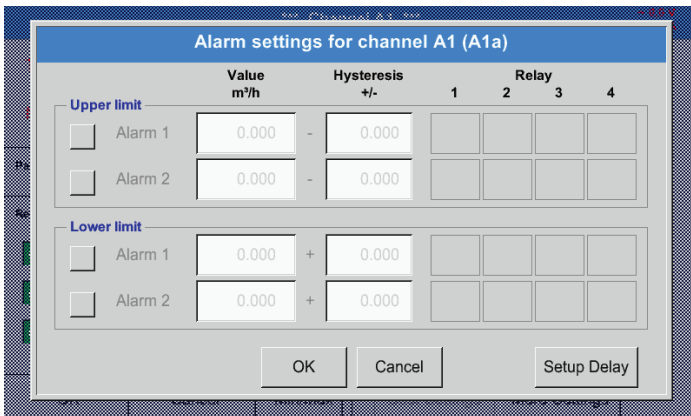

In the alarm settings, you have the option to enter **Alarm 1** and **Alarm 2** including the **Hysteresis** for each channel.

The alarm settings can also be configured in the **Alarm overview** menu (accessible from Main menu).

Main menu ► Settings ► Sensor settings ► A1 ► Alarm button ► Alarm 1 and Alarm 2 buttons + Relay buttons

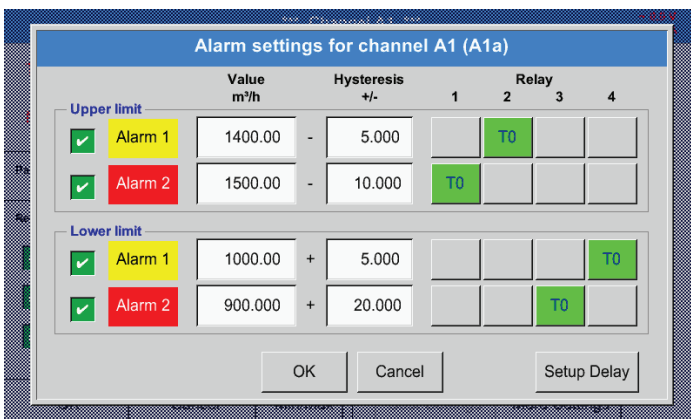

In the example, **Alarm 1** is set to relay 2 and relay 4, and **Alarm 2** is set to relay 1 and relay 3.

Note:

Any relay can be set 32x to Alarm 1 or Alarm 2 respectively.

Main menu ► Settings ► Sensor settings ► A1 ► Alarm button ► Relay buttons

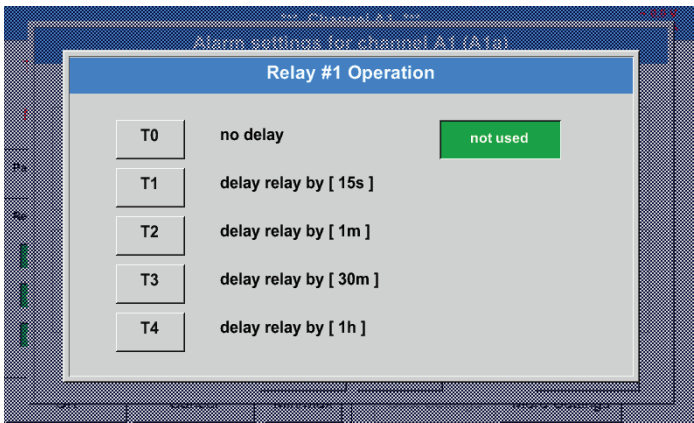

You can choose between 5 different delays.

Main menu ► Settings ► Sensor settings ► A1 ► Alarm button ► Delay

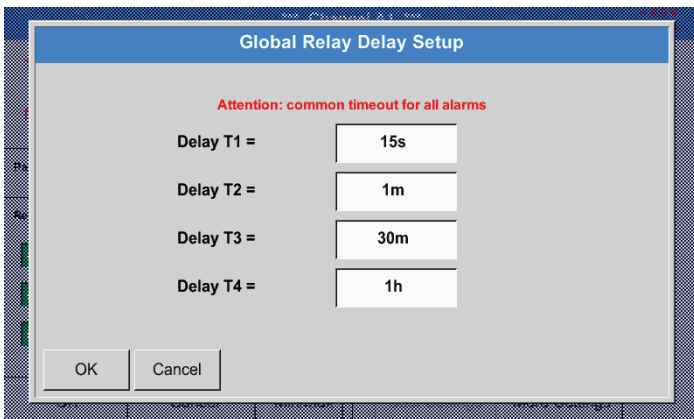

The set delays (T1 to T4) apply to all the relays.

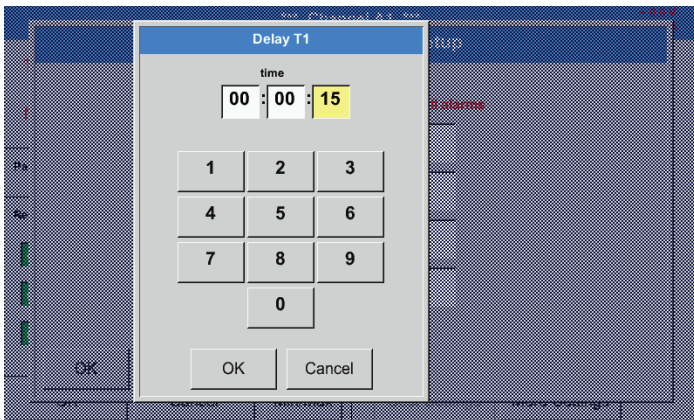

Enter the desired delay for T1.

Delay T0 cannot be modified and is used for instant alarms.

Confirm with **OK**.

Main menu ► Settings ► Sensor settings ► A1

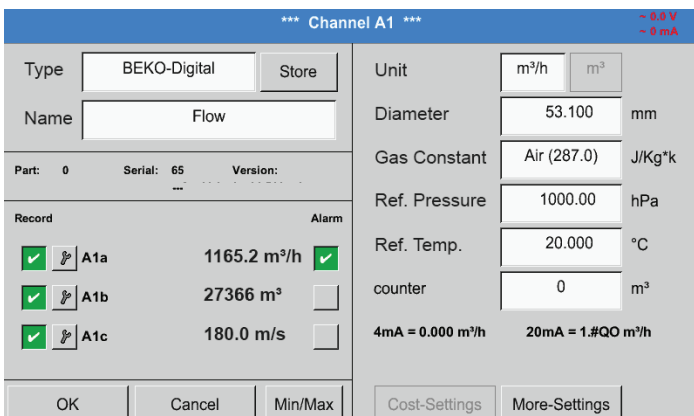

Screen of channel A1 after alarm configuration and activation.

Press **OK** to save and apply the settings.

12.2.2.5. Advanced settings (scaling of analog output)

Main menu ► Settings ► Sensor settings ► A1 ► Advanced settings

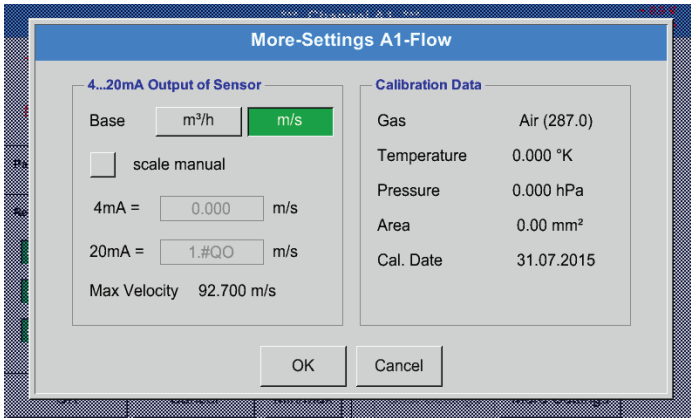

In the **Advanced settings**, you can determine whether the 4-20 mA analog output of the sensor is to be based on flow volume or velocity.

The selected field is displayed in green.

To set the measuring range, touch the **Manual scaling** button.

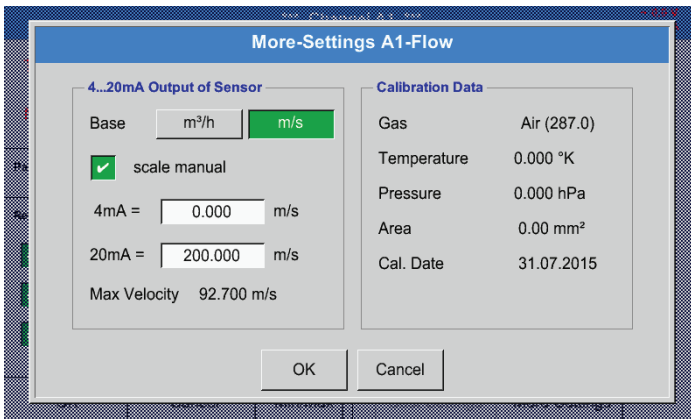

Press **OK** to save and apply the settings.

Note: **Advanced settings** are only available for **Digital**.

Press **OK** to save and apply the settings.

12.2.2.6. Dew point sensor DP 109 – SDI Digital

Step 1: select a free sensor channel

Main menu ► Settings ► Sensor settings ► B1

Step 2: select type "BEKO Digital"

Main menu ► Settings ► Sensor settings ► B1 ► Type ► BEKO Digital

Step 3: confirm 2x with OK

Configuration:

- Enter **Name** (see chapter 12.2.2.7 Labelling and configuring text fields)
- Enter alarm settings (see chapter 12.2.2.4 Alarm settings)
- Enter recording settings (see chapter 12.2.2.3 Recording measuring data)
- Enter the **Resolution** (decimal places) (see chapter 12.2.7.5 Defining resolution (decimals))

Main menu ► Settings ► Sensor settings ► B1

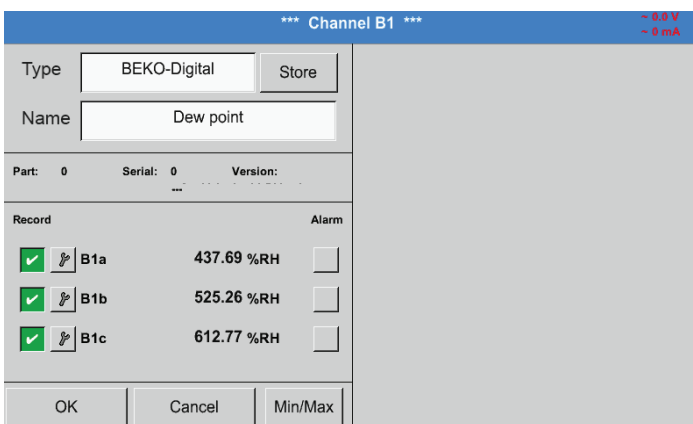

The BDL recognises whether the connected sensor is a BEKO flow or a dew point sensor, and automatically sets the **Digital** subtype.

NOTICE	SD23 settings
	The settings for the SD23 dew point sensor connected via RS485 or Modbus are described in chapter 12.2.3.3.

12.2.2.7. Labelling and configuring text fields

Main menu ► Settings ► Sensor settings ► A1

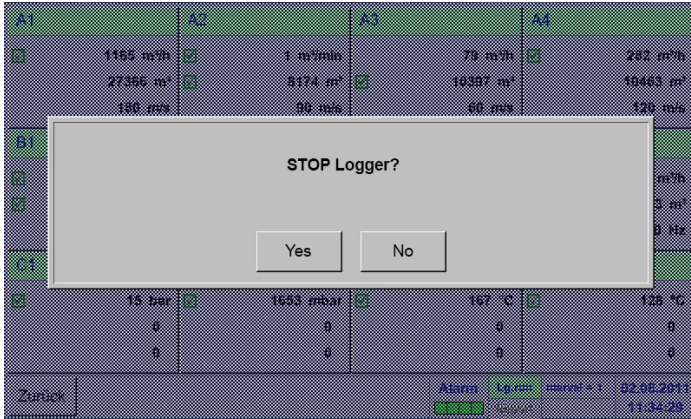

If the data logger is activated, the following window appears. Press **Yes** to activate the data logger.
(Data loggers are only activated if the relevant settings and recordings have been configured.)

Note:
 Before entering or changing sensor settings, set the data logger to **STOP**.

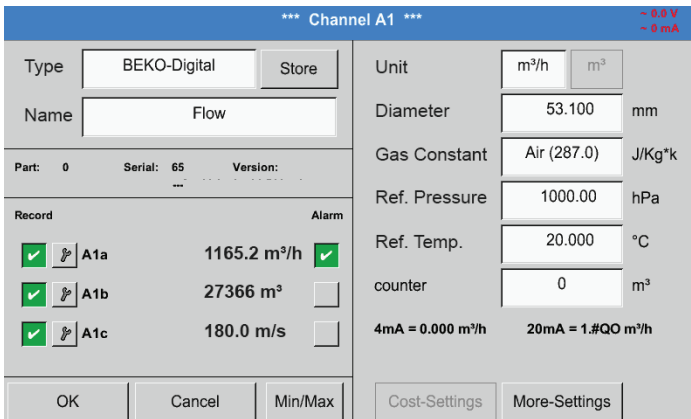

To enter or change a value, touch a white field.

The **Alarm** (see chapter 12.2.2.4 Alarm settings) and **Record** buttons (see chapter 12.2.2.3 Recording measuring data), the **Resolution** for digital places and the **Short name** and the **Value name** (see chapter 12.2.2.2 Labelling measurements and defining resolution), as well as the **Advanced settings** (see chapter 12.2.2.5 Advanced settings) are described in chapter 12.2.2 Sensor settings.

Main menu ► Settings ► Sensor settings ► A1 ► Name

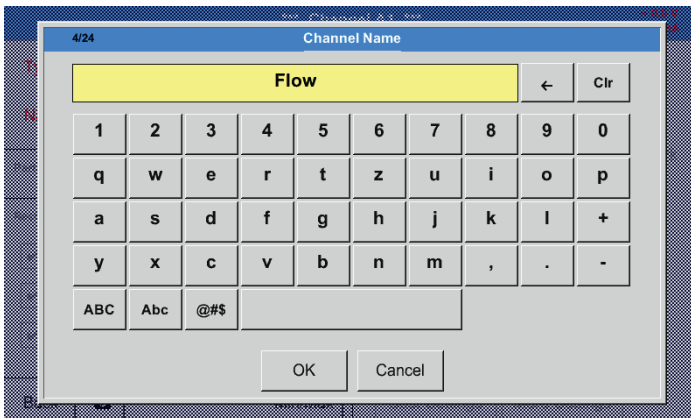

Field names must not be longer than 24 characters.

Main menu ► Settings ► Sensor settings ► A1 ► Type

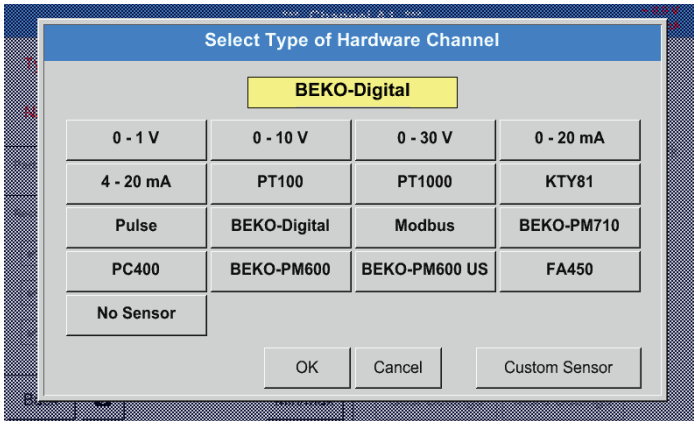

Touch the **Type** text field and select one of the available options (see screenshot).

See also chapter 12.2.2.8 Configuring analog sensors

Main menu ► Settings ► Sensor settings ► A1 ► Unit

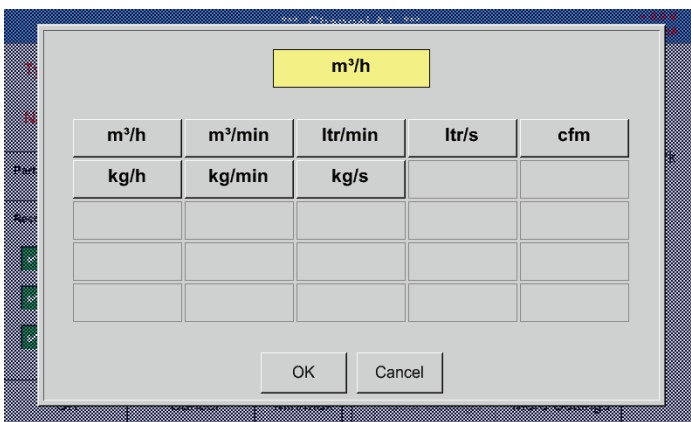

Preselection of matching **Units**.

Main menu ► Settings ► Sensor settings ► A1 ► Diameter

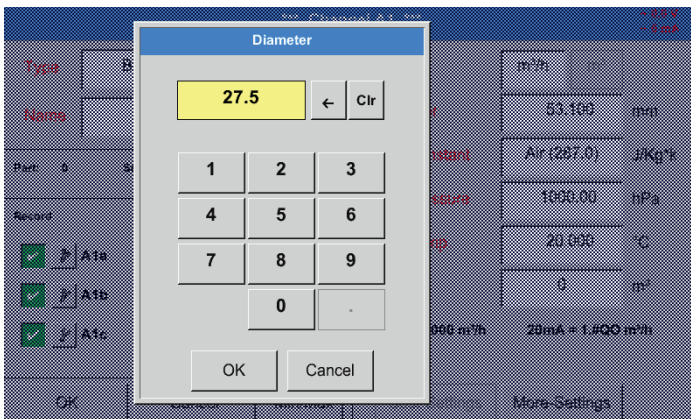

Important: Unless it has been automatically set, enter the **Inside diameter** of the flow pipe. In this example, the **Inside diameter** is 27.5 mm.

Important:

The **Inside diameter** should be as exact as possible, as this parameter affects the accuracy of the measuring results!

There is no general standard for inside diameter of pipes!
(Please ask the manufacturer or, if possible, measure the diameter yourself!)

Main menu ► Settings ► Sensor settings ► A1 ► Gas constant

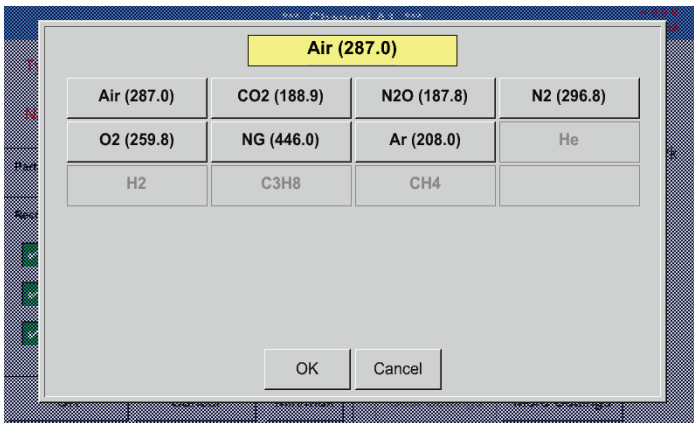

Preselection of matching Gas constants.

The remaining text fields can be labelled and configured in the same manner. For details, see chapter 12.2.2.7 Labelling and configuring text fields!

Main menu ► Settings ► Sensor settings ► A1

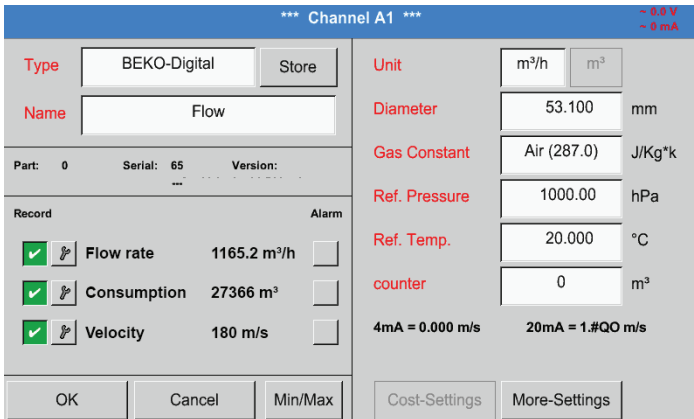

If a text field is displayed with red text, the respective values (e.g. Diameter or Name) have been changed.

The values for flow rate, consumption, and velocity will be recorded (green tick), as soon as the data logger is activated.

See also chapter 12.2.3.1 Selecting sensor type (example: digital sensor)

Note:

After confirming with OK, the field labels change back to black and the settings are applied.

Caution:

Reference temperature and reference pressure (factory settings 20 °C, 1000 hPa):

All volume flow (m³/h) and consumption (m³) values shown on the display refer to 20 °C and 1000 hPa (according to ISO 1217).

Alternatively, enter 0 °C and 1013 hPa (=standard cubic metre according to DIN 1343) as the reference values. Do not enter the operating pressure or the operating temperature as the reference values!

12.2.2.8. Configuring analog sensors

Overview of the possible **Type** settings, including examples.

Exception: **BEKO Digital**; for details, see chapters 12.2.3.1 Selecting sensor type (example: BEKO Digital sensor) and 12.2.2.6 BEKO Digital dew point sensor.

The **Alarm** (see chapter 12.2.2.4 Alarm settings) and **Record** buttons (see chapter 12.2.2.3 Recording measuring data), the **Resolution** for digital places and the **Short name** and the **Value name** (see chapter 12.2.2.2 Labelling measurements and defining resolution) are described in chapter 12.2.2 Sensor settings.

For the labelling of the text fields, see chapter 12.2.2.7 Labelling and configuring text fields!

12.2.2.8.1. Type 0 – 1/10/30 V and 0/4 – 20 mA

Main menu ► Settings ► Sensor settings ► C3 ► Type ► 0 – 1/10/30 V

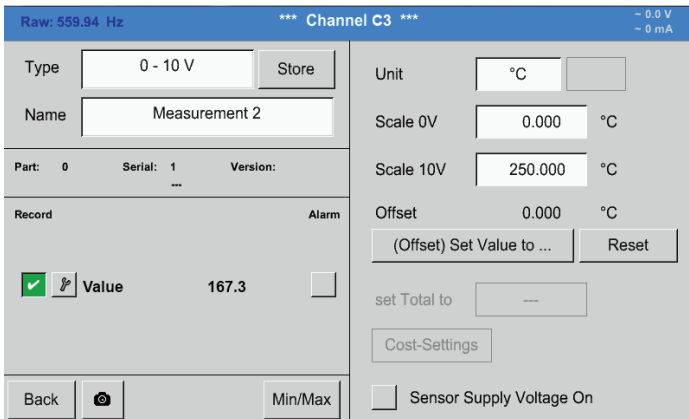

For details regarding the scaling of the sensor (here: type 0 – 10 V, corresponding to 0 – 250 °C), refer to the data sheet of the sensor.

In **Scal. 0 V**, enter the lower scale limit.
In **Scal. 10 V** enter the upper scaling limit.

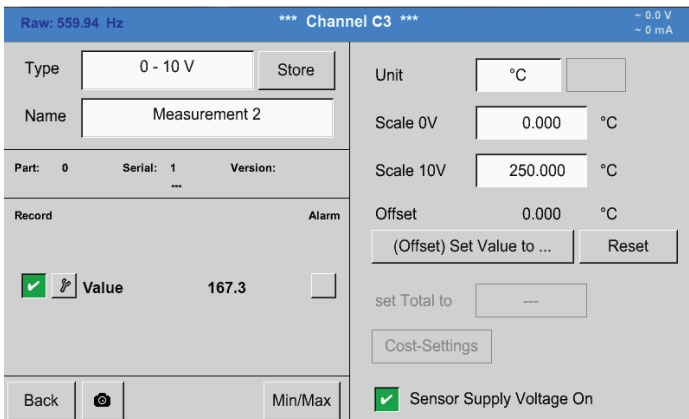

The **Ext. sensor supply voltage** is switched on when the sensor requires it.

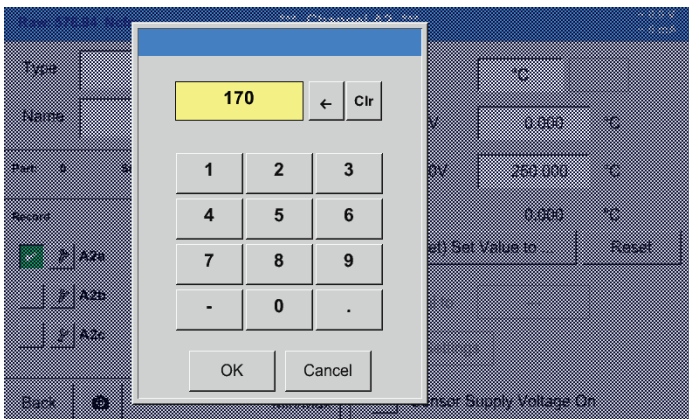

Press the **Set value to (offset)** button to set the measured data from the sensor to a certain value (offset).
The positive or negative difference of the **Offset** is displayed.

Press the **Reset** button, to reset the **Offset** to zero.

Main menu ► Settings ► Sensor settings ► C1 ► Type ► 0/4-20mA

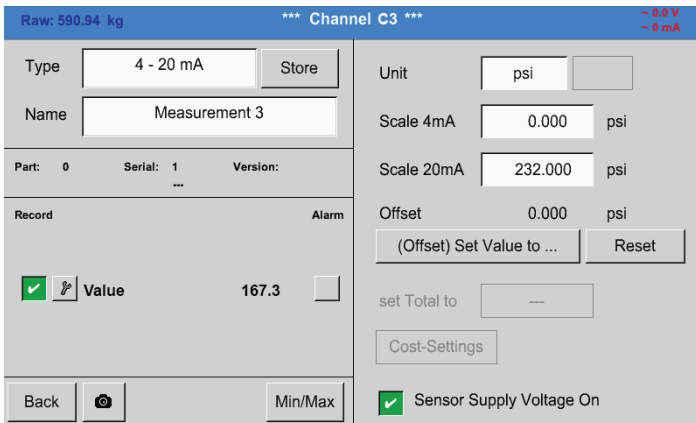

Here: Type 4 – 20 mA.

Main menu ► Settings ► Sensor settings ► C1 ► Unit

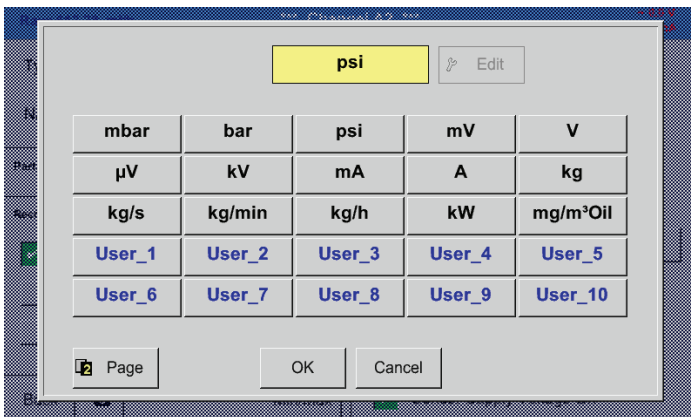

Preselection of suitable units for Type 0 – 1/10/30 V and 0/4 – 20 mA.

12.2.2.8.2. Type PT100x

Main menu ► Settings ► Sensor settings ► C4 ► Type ► PT100x

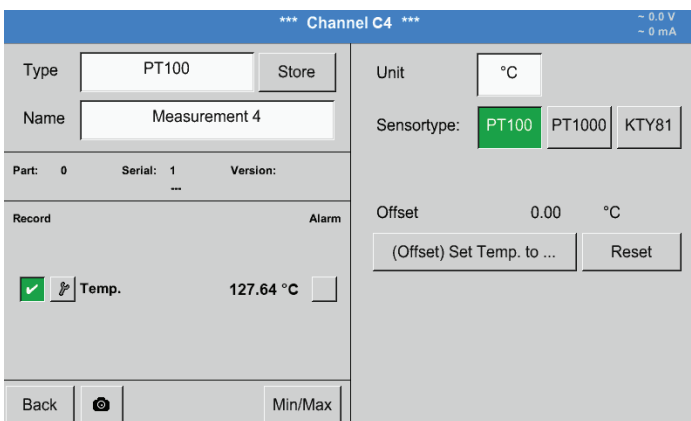

In the example sensor type PT100 and Unit °C have been chosen. Alternatively, select the sensor types PT1000 and KTY81, and Unit °F.

For additional options, refer to chapter 12.2.2.8.1 Type 0 – 1/10/30 V and 0/4 – 20 mA!

12.2.2.9. Type "Pulse"

Main menu ► Settings ► Sensor settings ► B3 ► Type ► Pulse

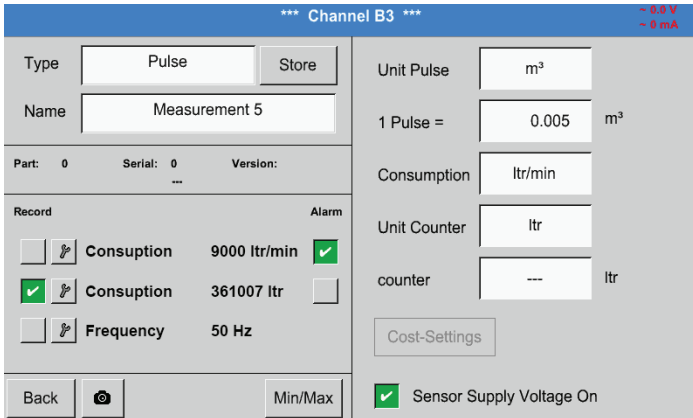

Normally, the numerical value and the unit for 1 pulse is displayed at the sensor and can be entered in the 1 pulse field.

Notice:
In the example, all text fields are already labelled and/or assigned.

Main menu ► Settings ► Sensor settings ► B3 ► Pulse unit

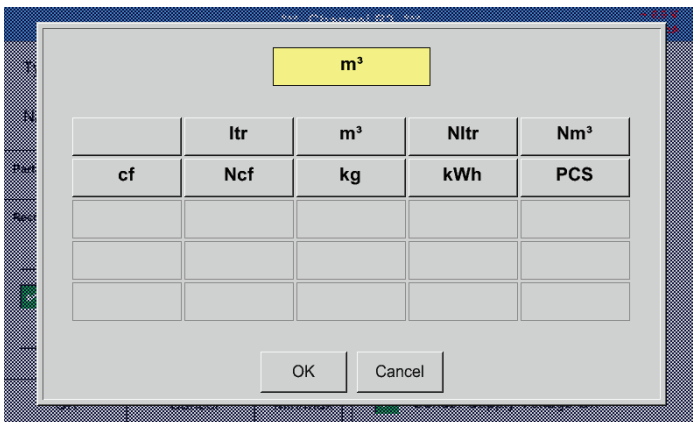

For the Pulse unit, choose a flow rate or a power consumption value.

Main menu ► Settings ► Sensor settings ► B3 ► Consumption

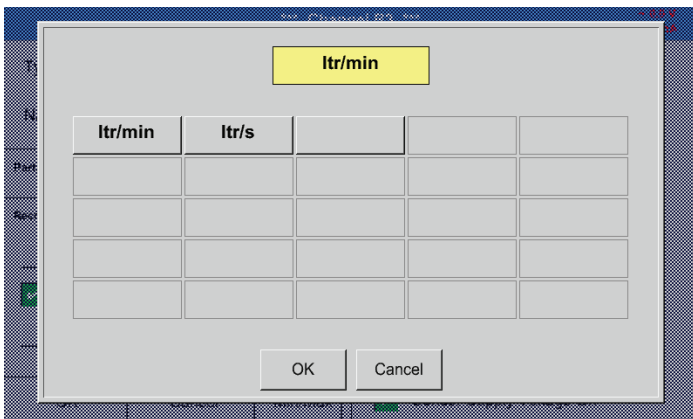

Units for the current Consumption for Type "Pulse".

Notice:
Here: cubic metres!

Main menu ► Settings ► Sensor settings ► B3 ► Counter unit

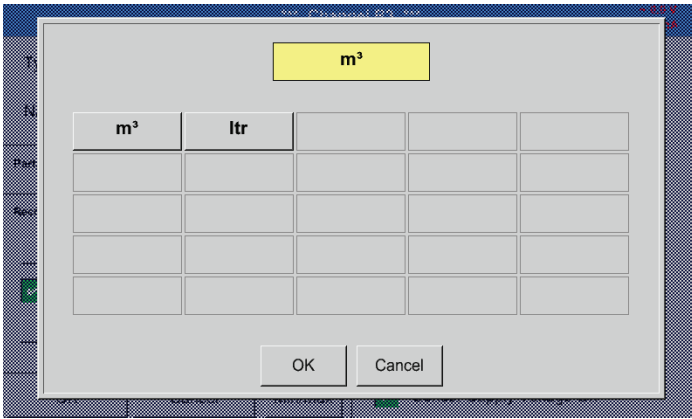

Available units for Counter unit and type "Pulse"

The Counter can be reset or set to a desired value at any time.

For additional options, see chapter 12.2.2.8.1 Type 0 – 1/10/30 V and 0/4 – 20 mA!

12.2.2.9.1. Type RS485

Main menu ► Settings ► Sensor settings ► C3 ► Type ► RS485

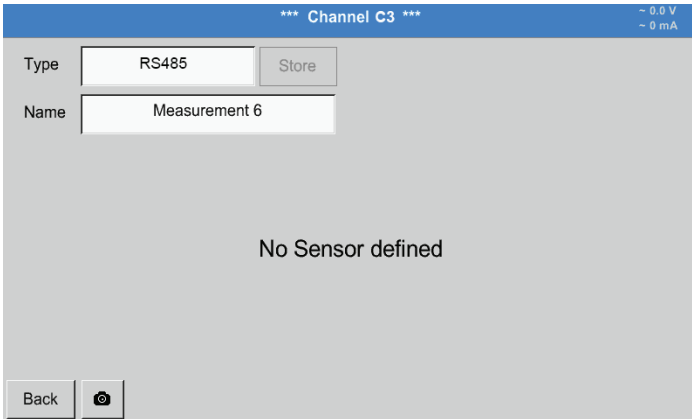

The RS485 bus/interface allows customers to connect their own systems (BMS, PLC, SCADA) to the BDL.

12.2.2.9.2. Type "No sensor"

Main menu ► Settings ► Sensor settings ► A1 ► Type ► No sensor

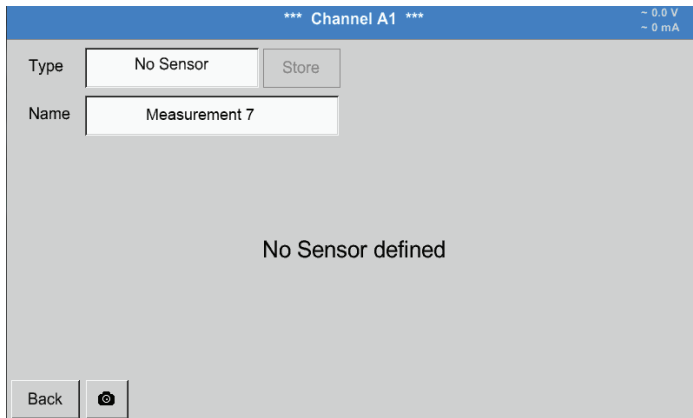

This option is used to temporarily disable a channel that is not in use.

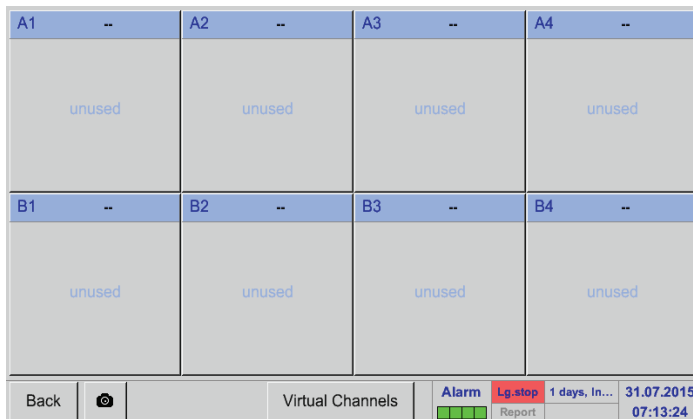

When returning from **No sensor** to the respective sensor settings, the respective channel (here: channel A1) displayed as **free**.

12.2.3. Type "Modbus"

12.2.3.1. Selecting and activating sensor type

Step 1: select a free sensor channel

Main menu ► Settings ► Sensor settings ► B3

Step 2: select Modbus type

Main menu ► Settings ► Sensor settings ► B3 ► Type ► Modbus

Step 3: confirm with OK

Enter a name (see chapter „12.2.2.7. Labelling and configuring text fields“, page 53).

Main menu ► Settings ► Sensor-settings ► B3 ► VA ► use

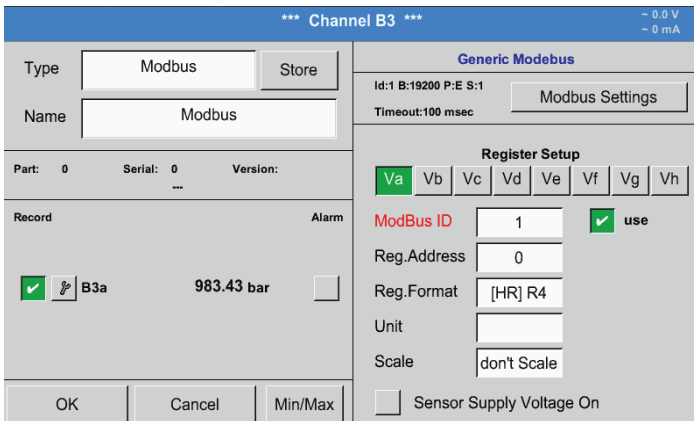

Via Modbus, up to 8 register values (from the input or holding registers) of the sensor can be read out.

Select one or more registers (Va –Vh) and activate by checking the use box.

12.2.3.2. General Modbus settings

Main menu ► Settings ► Sensor settings ► ► Modbus ID

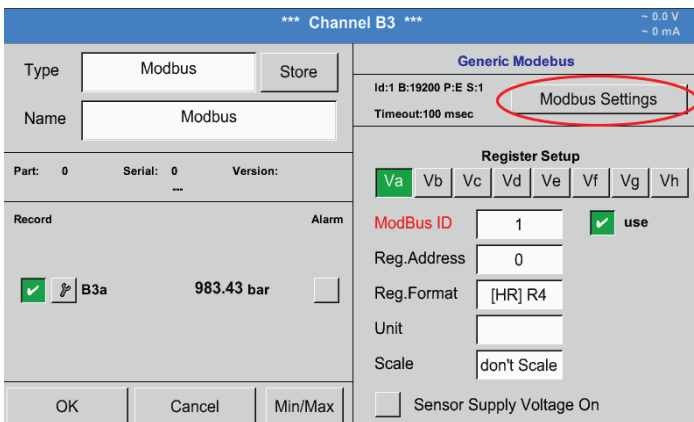

Enter the Modbus ID of the sensor; available values: 1 – 247.

The Modbus ID is specified in the sensor data sheet.

Main menu ► Settings ► Sensor settings ► B3 ► Modbus settings

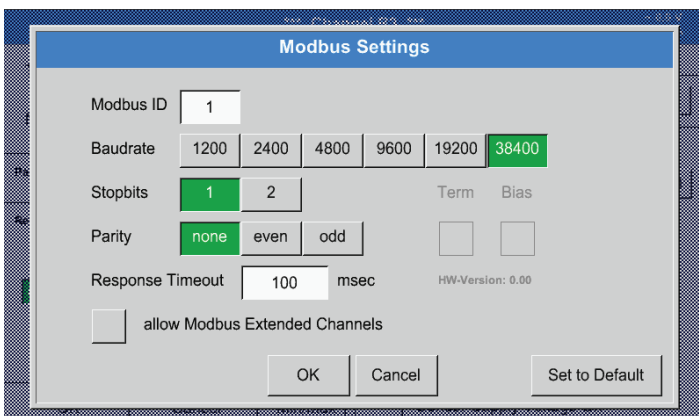

Enter all serial transmission settings such as baud rate, stop bit, parity bit, and timeout. For details, refer to the data sheet of the sensor/ transducer.

Confirm the changes with OK. To reset the values to the default settings, press the Restore defaults button.

Main menu ► Settings ► Sensor settings ► B3 ► Reg. address

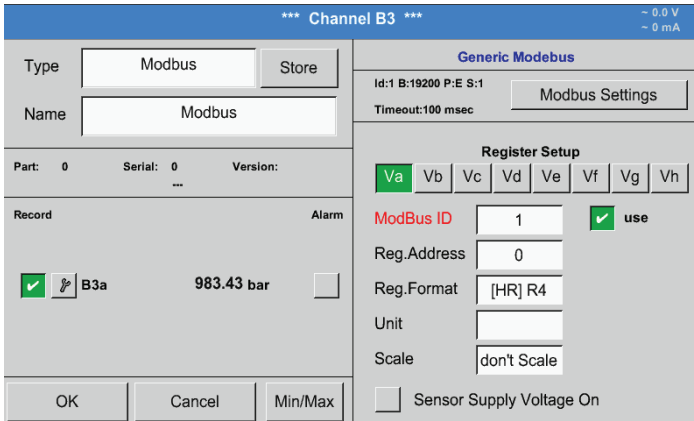

The sensor stores the measured values in registers. These values can be addressed by the BDL and read out via Modbus. For this purpose, specify the register addresses in the BDL. The Register/data address is a decimal value between 0 and 65535.

Important:

Ensure that the correct Register address is entered. The register address might deviate from the register number (offset). For details, refer to the sensor/transducer data sheet.

Main menu ► Settings ► Sensor settings ► B3 ► Reg. format

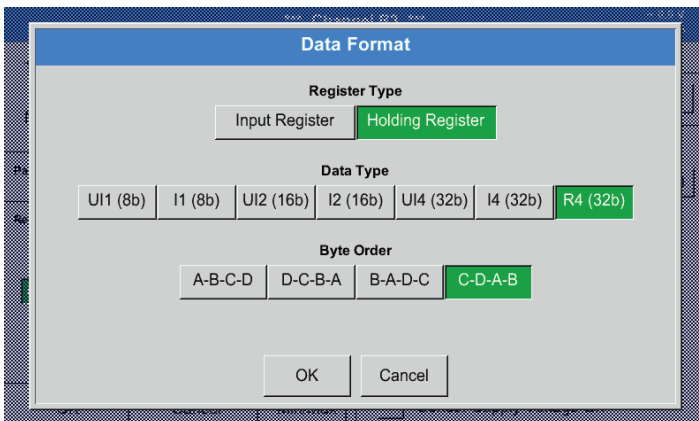

Press the Input register and Holding register buttons, to select the Modbus register type.

Select the Data type and the Byte order. These settings are used in combination.

Supported data types:

Data Type:	UI1(8b) = unsigned integer	=>	0	-	255
	I1 (8b) = signed integer	=>	-128	-	127
	UI2 (16b) = unsigned integer	=>	0	-	65535
	I2 (16b) = signed integer	=>	-32768	-	32767
	UI4 (32b) = unsigned integer	=>	0	-	4294967295
	I4 (32b) = signed integer	=>	-2147483648	-	2147483647
	R4 (32b) = floating point number				

Byte order:

The Modbus register has a capacity of 2 bytes. For a 32-bit value, two Modbus registers are read by the BDL. For a 16-bit value, only one register is read.

The Modbus specifications do not accurately describe the byte order in which data is transferred. In order to cater for all possible configurations, the byte order can be freely adjusted in the BDL, as it must be adjusted to match that of the respective sensor (see sensor/transducer data sheet).

Example: high byte before low byte, high word before low word, etc.

The byte order must be configured based on the information in the sensor/transducer data sheet.

Examples:

Holding register – UI1(8b) – numerical value: 18

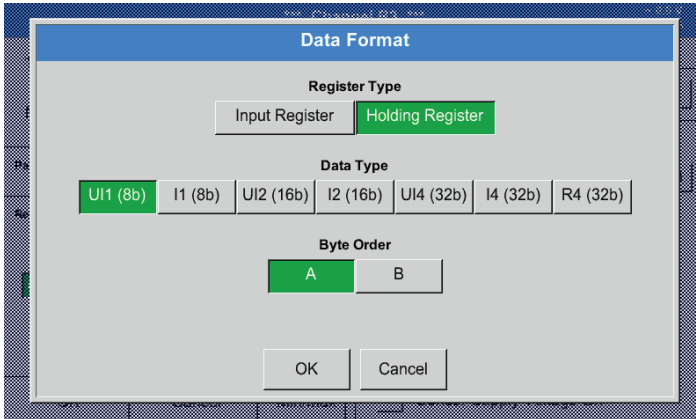

Select register type **Holding register**, data type **U1 (8b)** and byte order **A / B**.

	HByte	LByte
18 =>	00	12
Data Order	1. Byte	2. Byte
A	00	12
B	12	00

Holding register – UI4(32) – numerical value: 29235175522 ▶ AE41 5652

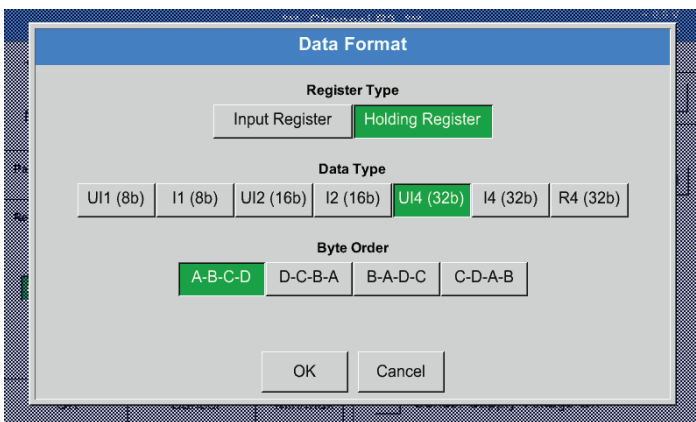

Select register type **Holding register**, data type **U1 (32b)** and byte order **A-B-C-D**.

	HWord		LWord	
	HByte	LByte	HByte	LByte
29235175522 =>	AE	41	56	52
Data Order	1.Byte	2.Byte	3.byte	4.Byte
A-B-C-D	AE	41	56	52
D-C-B-A	52	56	41	AE
B-A-D-C	41	AE	52	56
C-D-A-B	56	52	AE	41

Main menu ▶ Settings ▶ Sensor settings ▶ B3 ▶ Unit

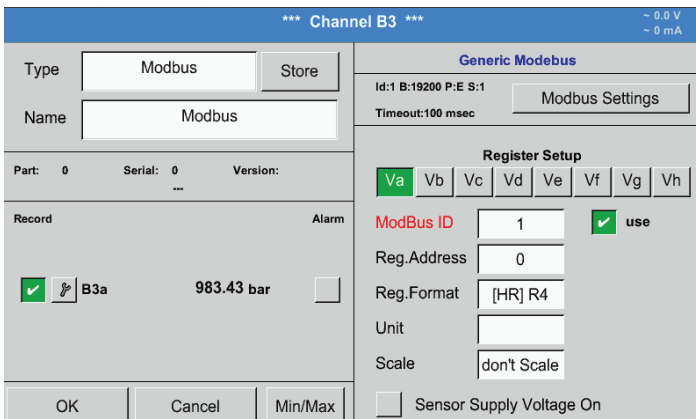

Touch the "Unit" text field to call up a list of the available units.

Select the unit by pressing the respective unit button. Press the **OK** button to apply the unit.

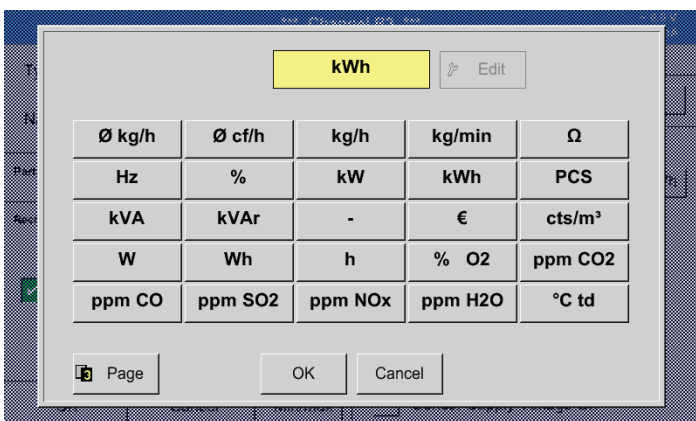

To change between the individual list pages, press the **Page** button. If the required unit is not available, create it yourself. To do this, press one of the pre-defined **User_x** buttons.

Main menu ► Settings ► Sensor-settings ► B3 ► Scal. text field

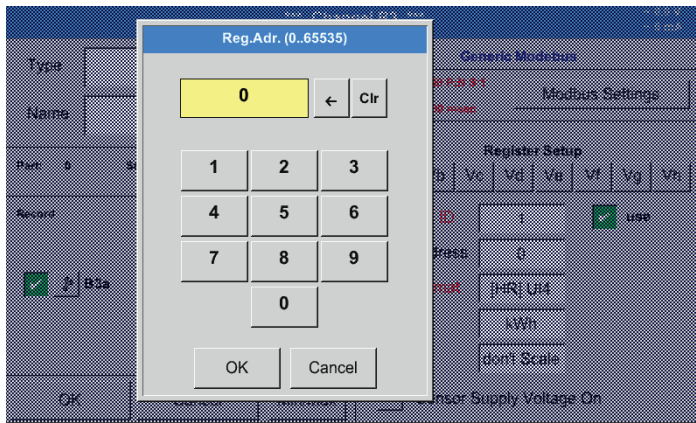

Enter a factor that is applied to adjust the respective output value.

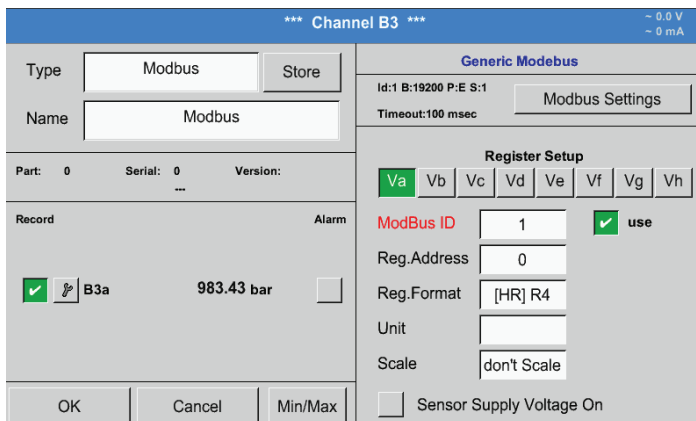

Press the **OK** button to store and apply the user-defined factor.

12.2.3.3. Modbus settings for METPOINT® SD23

When connecting a METPOINT® SD23 via Modbus, the following settings are required:

Step 1: select a free sensor channel

Main menu ► Settings ► Sensor settings ► Select a free channel (here: channel A1)

Step 2: select Modbus type

Select Main menu ► Settings ► Sensor settings ► A1 ► Type ► Modbus and confirm with >OK<.

Step 3: enter a name

Main menu ► Settings ► Sensor settings ► A1 ► Name

Enter a name.

Step 4: define the Modbus settings

Main menu ► Settings ► Sensor settings ► A1 ► Modbus settings

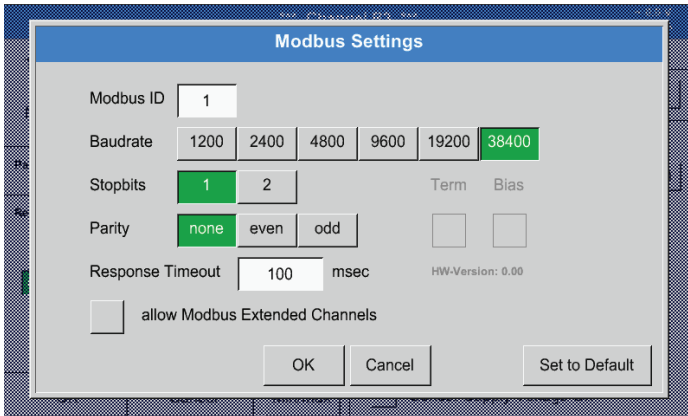

The Modbus ID is specified in the data sheet of the sensor (here: 1).

Adjust the other parameter settings according to the screenshot.

NOTICE	Text fields settings
	Further information on how to configure the text fields, see chapter 12.2.2.7.

Step 5: select register

Main menu ► Settings ► Sensor-settings ► A1 ► VA ► use

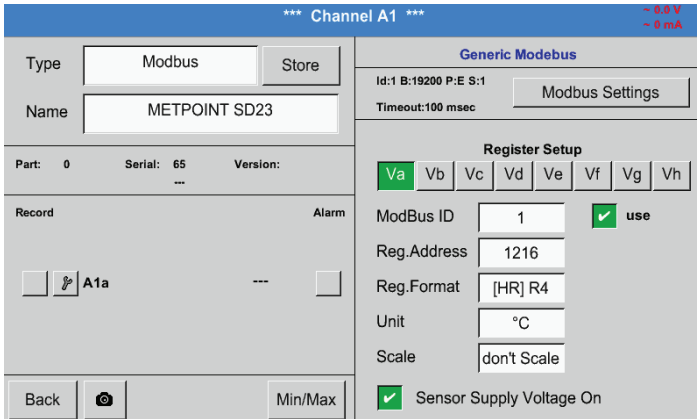

Proceed in the same manner to select the other registers.

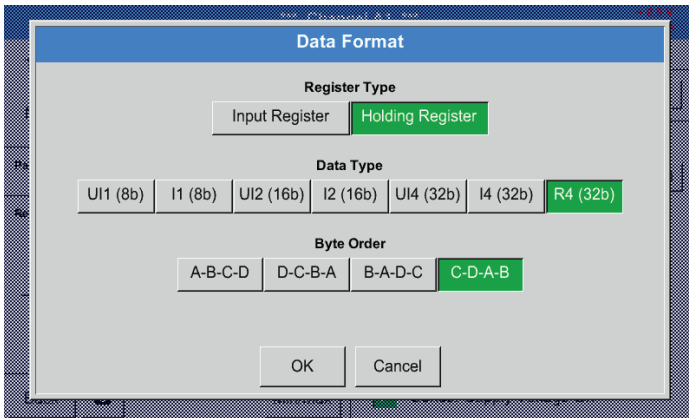

The settings for the register/data format apply to all registers.

Step 6: enter Modbus parameters

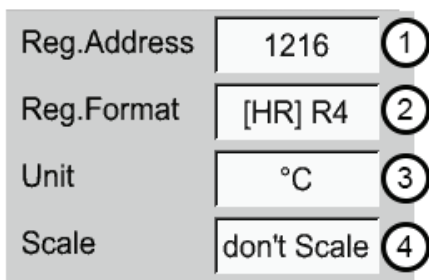

To enter the Modbus parameters, press the white buttons (1) – (4).

The following parameters can be retrieved from the respective registers:

Register	Designation	Register address	Register format	Unit	Scal.
Va	Temperature	1216	[HR] R4	°C	No scal.
Vb	Rel. humidity	1152	[HR] R4	% rH	No scal.
Vc	Dew point/frost point	1536	[HR] R4	°C	No scal.
Vd	Dew point	1472	[HR] R4	°C	No scal.
Ve	Temperature	2944	[HR] R4	°C / °F	No scal.
Vf	Dew point/frost point	3008	[HR] R4	°F _{td}	No scal.

12.2.4. Logger settings (data logger)

Main menu ► Settings ► Logger settings

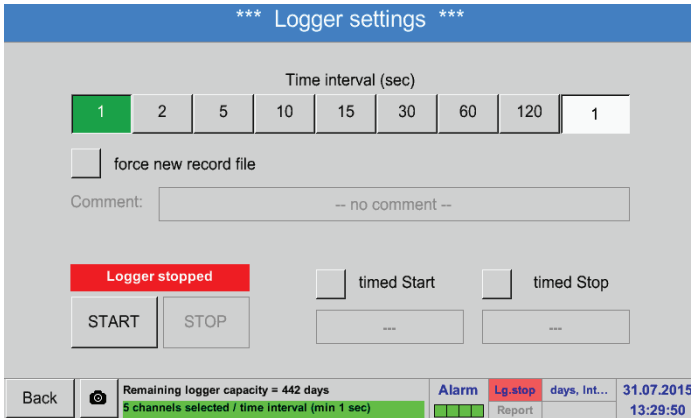

In the top row, select one of the pre-defined **Intervals** (1, 2, 5, 10, 15, 30, 60, and 120 seconds) for recording.

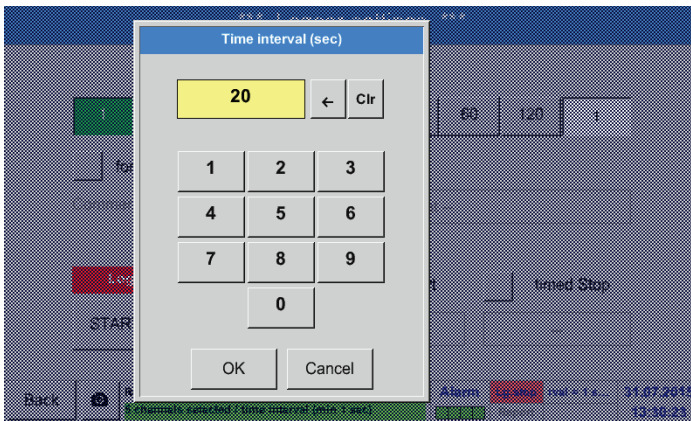

Alternatively, enter a user-defined **Interval** in the white text field in the top right corner showing the currently selected **Interval** (here: 20 seconds).

Notice:
The longest possible **Interval** is 300 seconds (5 minutes).

Notice:

If more than 12 measurements are recorded simultaneously, the shortest possible data logger interval is 2 seconds.

If more than 25 measurements are recorded simultaneously, the shortest possible data logger interval is 5 seconds.

Main menu ► Settings ► Logger settings ► Enforce new logger file
 or
 Main menu ► Settings ► Logger settings ► Enforce new logger file ► Comment

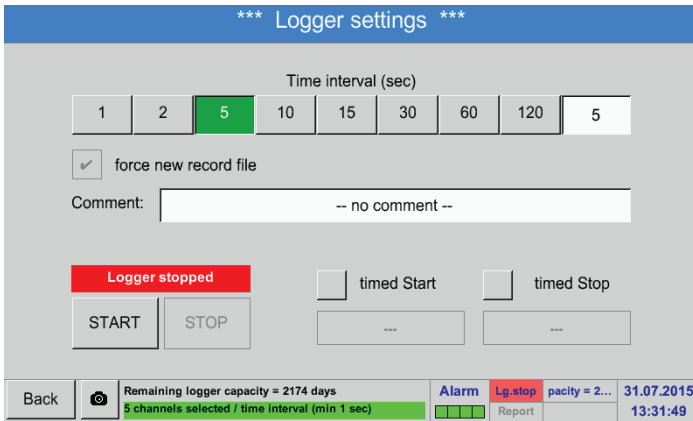

Check the **Enforce new logger file** box to create a new recording file with the name/comment entered in the **Comment** text field.

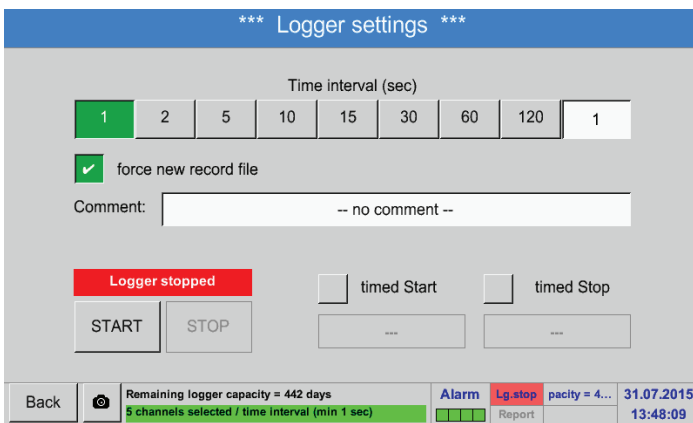

Important:
 To create a new logger (recording) file, check the **Enforce new logger file** box.

Otherwise, the last created logger (recording) is used.

Main menu ► Settings ► Logger settings ► Start time button

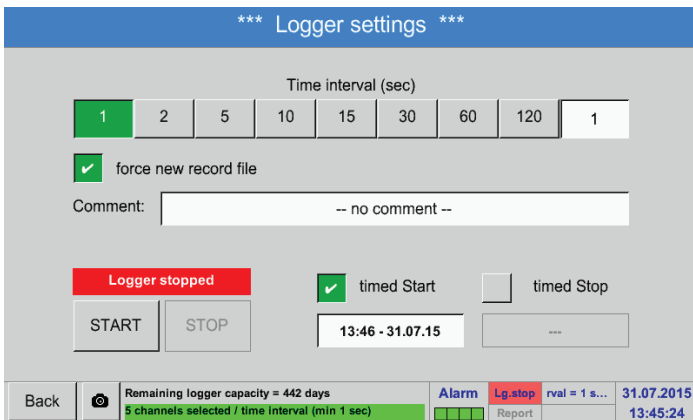

Check the **Start time** box and enter the start date/time for the data logger recording in the fields below the box.

Notice:
 When the **Start time** box is checked, the current time plus 1 minute is displayed in the date/time field.

Main menu ► Settings ► Logger settings ► Stop time button

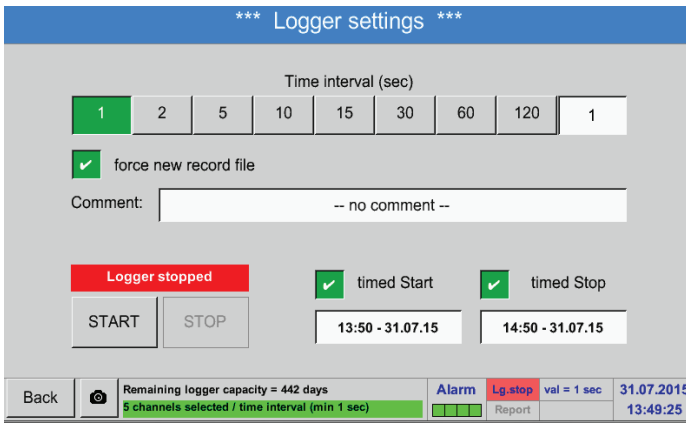

Check the **Stop time** box and enter the stop date/time for the data logger recording in the fields below the box.

Notice: When the **Stop time** box is checked, the current time plus 1 hour is displayed in the date/time field.

Main menu ► Settings ► Logger settings ► Start time button/Stop time button ► Date/time

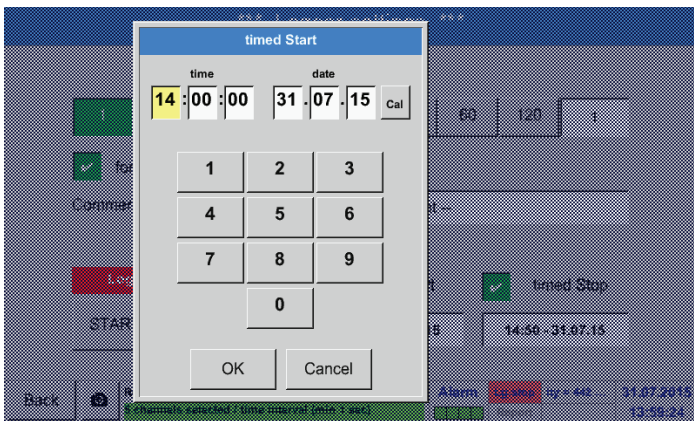

Touch the **Date/time** text field. A window where you can enter the date and time by entering the relevant values in the yellow box.

Main menu ► Settings ► Logger settings ► Start time button/Stop time button ► Date/time ► Calendar button

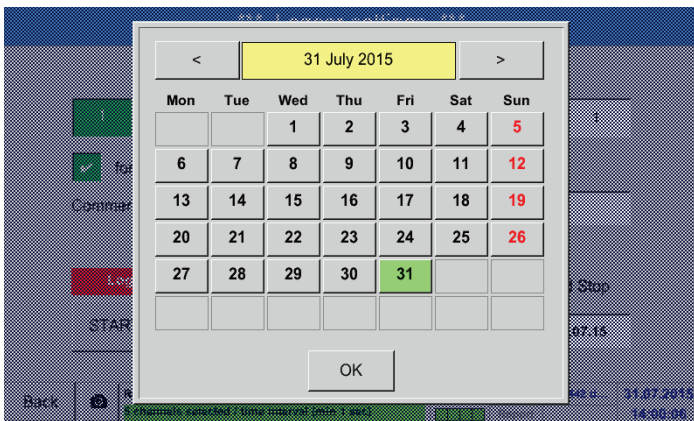

Press the **Calendar** button to select the date from the calendar.

Main menu ► Settings ► Logger settings ► Start button

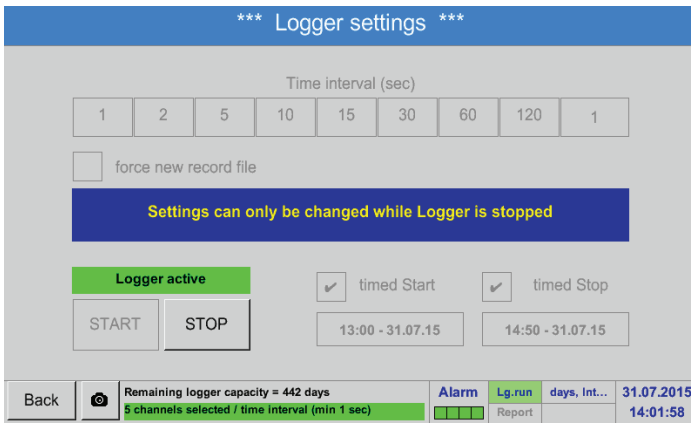

After the **Start time** and/or **Stop time** has been set, press the **Start** button to set the data logger to "armed".

The data logger will start recording at the set time!

Main menu ► Settings ► Logger settings ► Start button/stop button

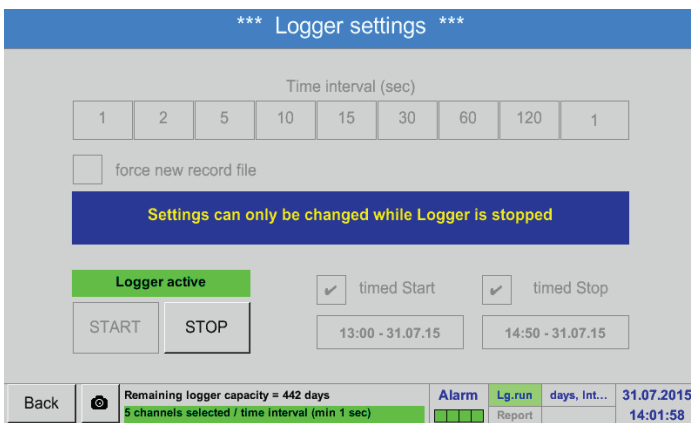

The data logger can also be started and stopped without time settings. To do this, simply press the **Start** and **Stop** button. The field in the bottom left corner indicates the number of values that are recorded and the remaining recording time.

Notice:

The settings cannot be changed while the data logger is recording.

Important:

If a new logger (recording) file is to be created, check the **Enforce new logger file** box. Otherwise, the last created logger (recording) is used.

12.2.5. Device settings

Main menu ► Settings ► Device settings

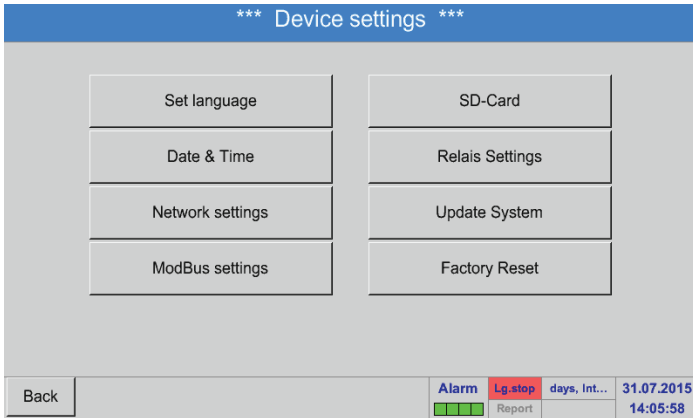

Overview of device settings

12.2.5.1. Language

Main menu ► Settings ► Device settings ► Language



Select the language for the BDL interface.

Notice:
At the moment, only German and English are available!

12.2.5.2. Date & time

Main menu ► Settings ► Device settings ► Date & time

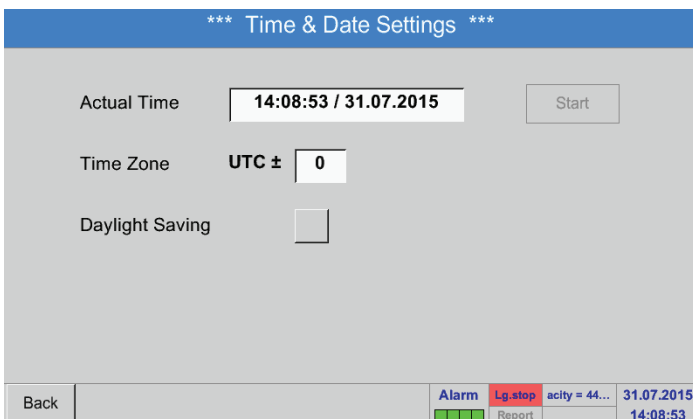

Touch the Time zone field and enter the correct UTC.

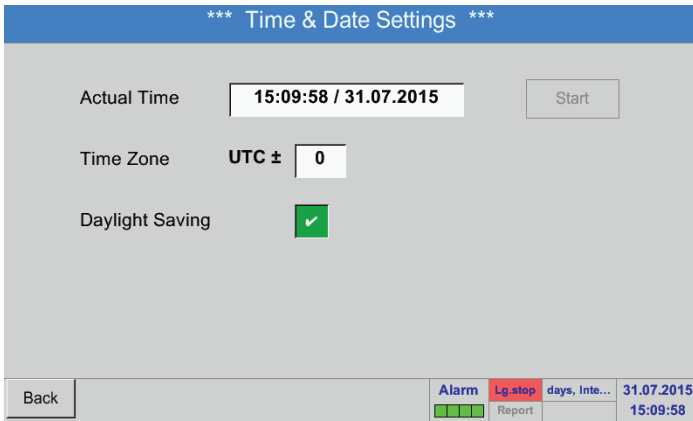

To cater for daylight saving time, check the **Daylight saving** box.

12.2.5.3. Network settings

Main menu ► Settings ► Device settings ► Network settings

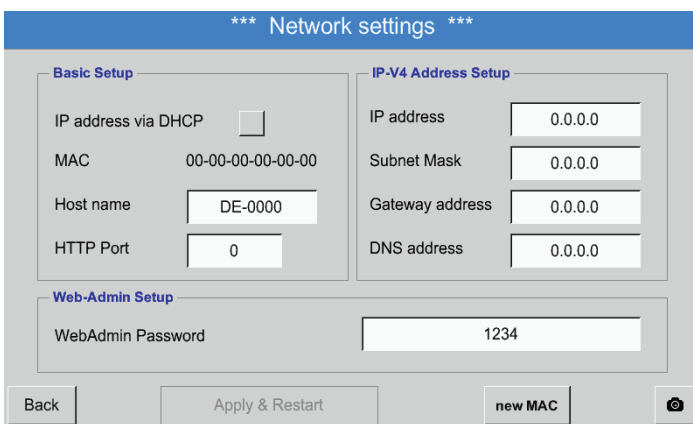

Here, a connection to a computer can be configured, with or without **DHCP**.

Notice:
If the **DHCP** box is ticked, the BDL is automatically integrated into the existing network. In this case, there is no need to manually configure the network settings.

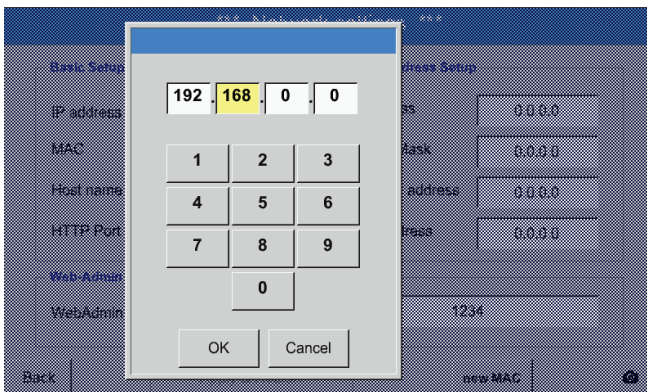

Alternatively, enter the relevant network settings in the fields:
Touch the **IP address** field. An input window is displayed where the relevant entries can be made in the yellow box.
Touch the **Host name** field to enter or change the host name.

Enter the **Subnet mask** and **Gateway address** in the respective fields.
(For **Host name**, see chapter 12.2.2.7 Labelling and configuring text fields.)

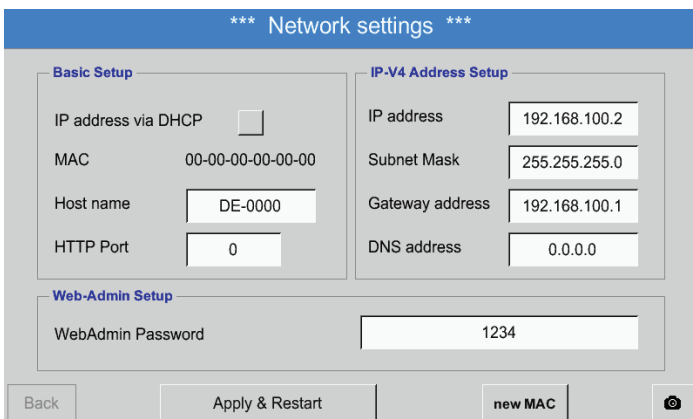

For the **IP address**, observe the IP address classes.

Notice:
Private address range in class A networks: 10.0.0.0 to 10.255.255.255
Private address range in class B networks: 172.16.0.0 to 172.31.255.255
Private address range in class C networks: 192.168.0.0 to 192.168.255.255
Subnet mask: e.g. 255.255.255.0

12.2.5.4. Modbus

Main menu ► Settings ► Device settings ► Modbus settings

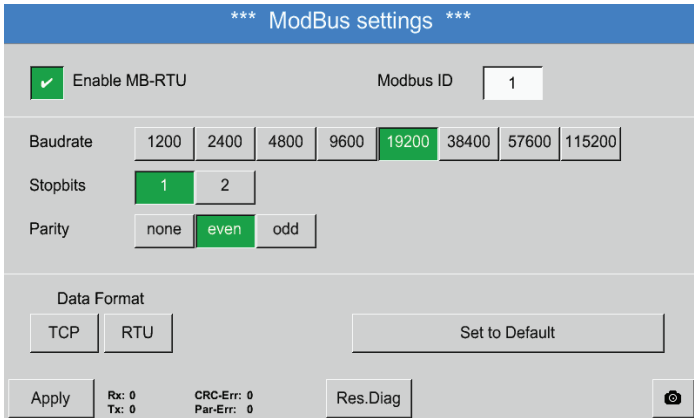

Enter the transmission parameters for **Modbus ID**, **baud rate**, **stop bit** and **parity**. To activate Modbus, check the "Enable Modbus RTU(RS485)" box. To reset the values to the default settings, press the **Restore defaults** button.

Default values: Baud rate: 19200
 Stop bit: 1
 Parity: even

12.2.5.5. SD card

Main menu ► Settings ► Device settings ► SD card ► Reset logger database

Main menu ► Settings ► Device settings ► SD card ► Erase SD card

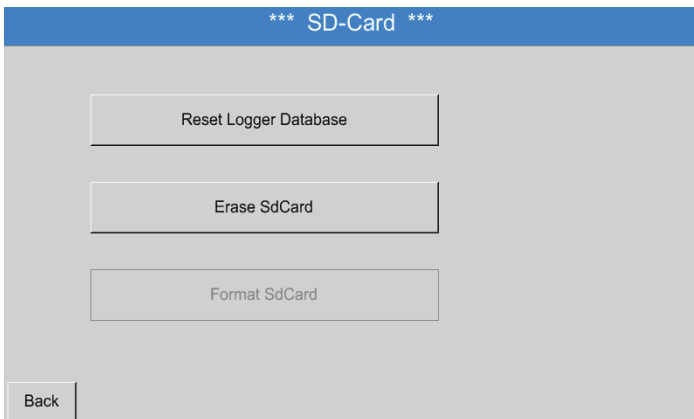

To lock the currently stored data for use by the BDL, press the **Reset logger database** button. The data remains stored on the SD card and is thus available for external use.

To delete all data from the SD card, press the **Erase SD card** button.

NOTICE	SD card settings and card replacement
	For detailed information regarding the SD card and its replacement, see chapter 11.

12.2.5.6. System update

Important:

Before carrying out an update, save the device settings to a USB memory stick!

Notice:

The yellow field shows the update options that are available.

Main menu ► Settings ► Device settings ► System update

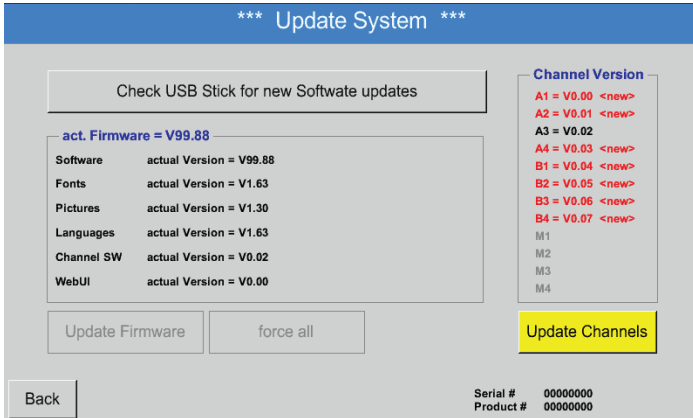

Overview of System update functions

Main menu ► Settings ► Device settings ► System update ► Save device settings

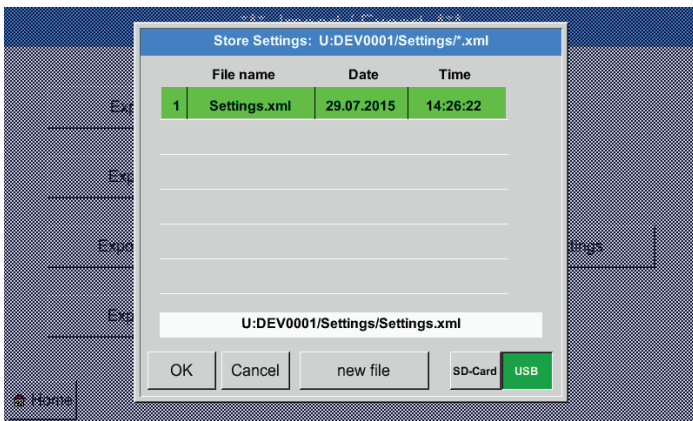

Saves Channel and system settings in XML format to a USB memory stick.

Main menu ► Settings ► Device settings ► System update ► Check for updates on USB memory stick

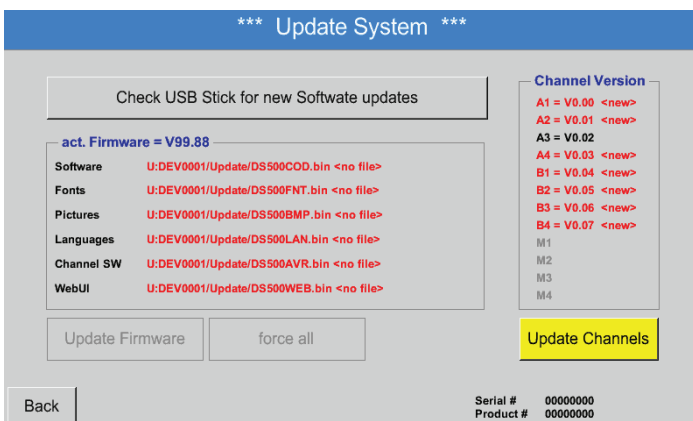

If the message shown here is displayed after pressing the Check for updates on USB memory stick button, the USB memory stick is not correctly connected to the BDL or the required data is not available.

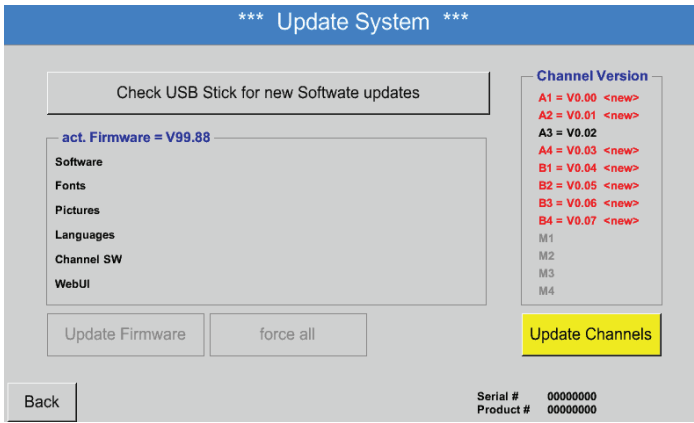

If the USB memory stick is correctly connected to the BDL, the letters change to black and the various available update options (software, pictures, etc.) are shown with a green tick to the left.

To the right, the current (old) and the available (new) versions are displayed.

If you wish to install a previous software version, the update options (software, graphs, etc.) must be selected manually.

Main menu ► Settings ► Device settings ► System update ► Update selection

BDL update for all of the selected options (software, pictures, etc.).

Important:

If, subsequent to the update, the **Restart** button is displayed, you must press it to restart the BDL!

Main menu ► Settings ► Device settings ► System update ► Update channels

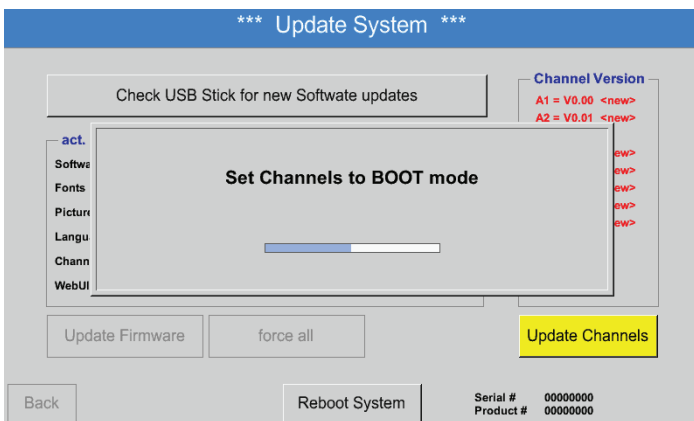

Update for the BDL channels.

Important:

If, subsequent to the update, the **Restart** button is displayed, you must press it to restart the BDL!

Main menu ► Settings ► Device settings ► System update ► Restore device settings



Press the **restore system settings** button to reset the channel and system settings to the last saved settings.



Important: After the channel and system settings have been reset, press the **OK** button and then press the **Restart** button to restart the BDL.

12.2.5.7. Restoring factory settings

Main menu ► Settings ► Device settings ► Restore factory settings

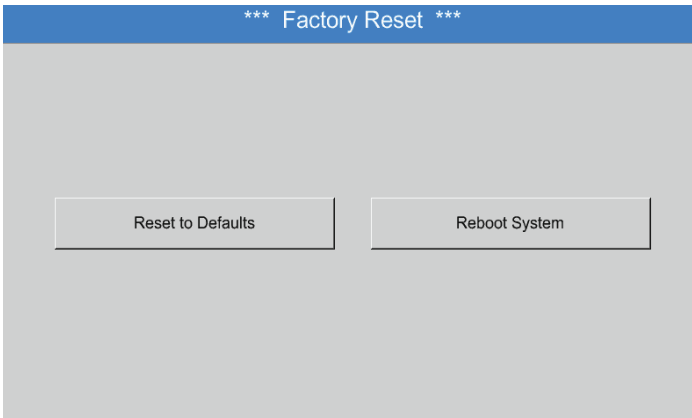

If required, the BDL can be re-booted by pressing the **Restart** button.

12.2.6. Report settings (optional)

Main menu ► Settings ► Report settings

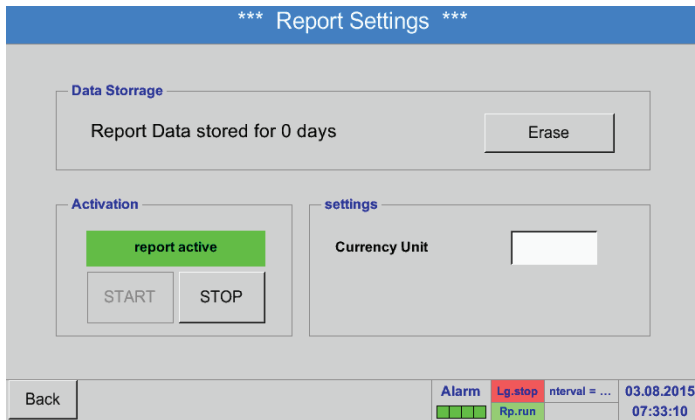

To start or stop reporting, press the **Start** or **Stop** button respectively.

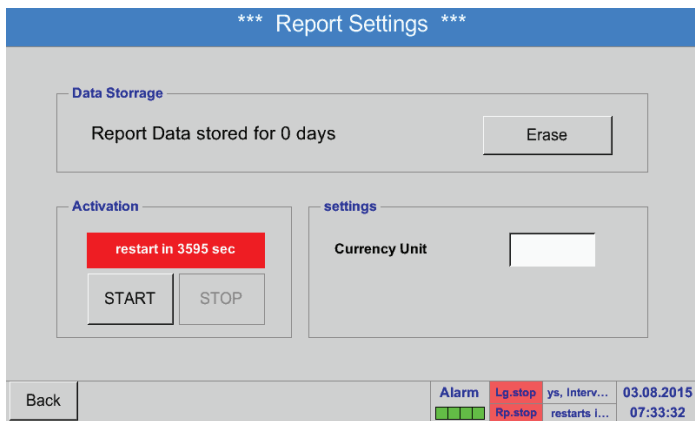

Notice:
After the **Stop** button has been pressed, reporting resumes automatically after 1 hour, unless the **Start** button has been pressed again.

Main menu ► Settings ► Report settings ► Delete button

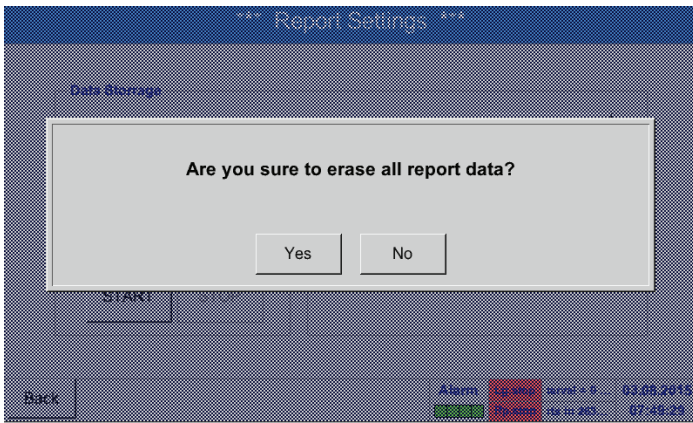

To delete Report data, press Yes.

Important:

Prior to deleting the data, export the Report data to a USB memory stick!

See also chapter 12.10 Data export

Main menu ► Settings ► Report settings ► Currency

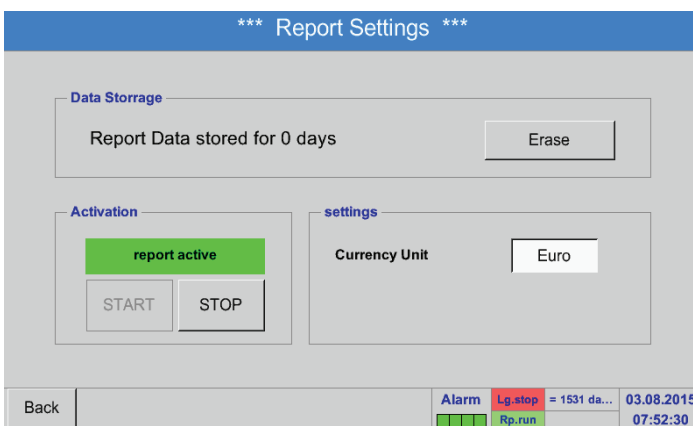

Press the Currency field to enter the currency that is to be used for the cost calculations and the Report.

Notice:

If no currency is entered, the respective fields remain empty.

See also chapters 12.8.1 Report/consumption analysis (optional) and 12.8.2 Costs (optional).

12.2.7. Virtual channels (optional)

The "Virtual channels" option offers 4 additional channels (no HW channels) for the display of calculations regarding the HW channels, virtual channels, and freely definable constants. For each virtual channel, up to 8 calculations with 3 operands and 2 operations can be configured.

Calculations are used to calculate:

- Specific performance of system
- Total consumption of system (with multiple compressors)
- Energy costs, etc.

12.2.7.1. Activating virtual channels

After having acquired the "Virtual channels" option, you must activate it.

Main menu ► Settings ► About BDL

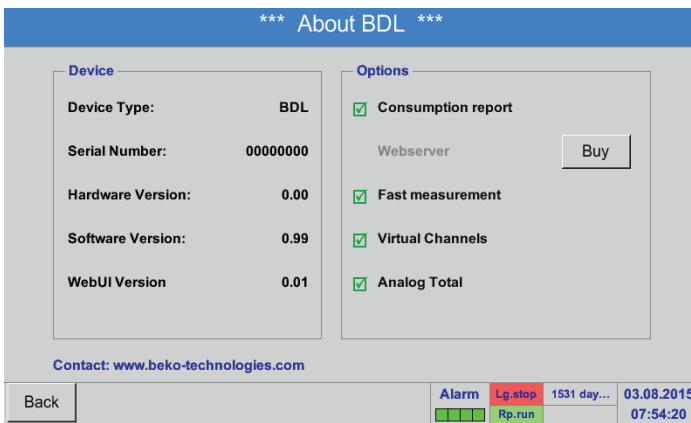

Press the **Buy** button for virtual channels. You are prompted to enter the activation code.

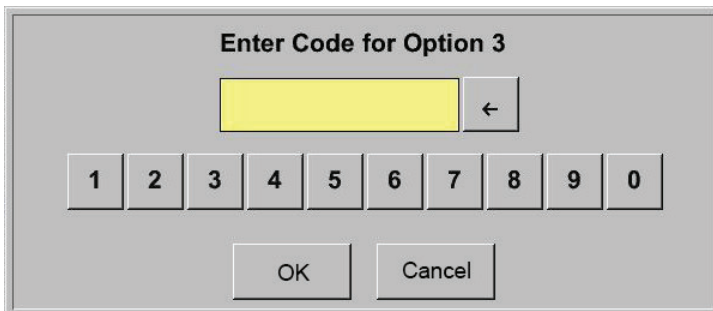

Enter your activation code and press the **OK** button.

12.2.7.2. Virtual channel settings

Main menu ► Settings ► Sensor settings ► Virtual channels

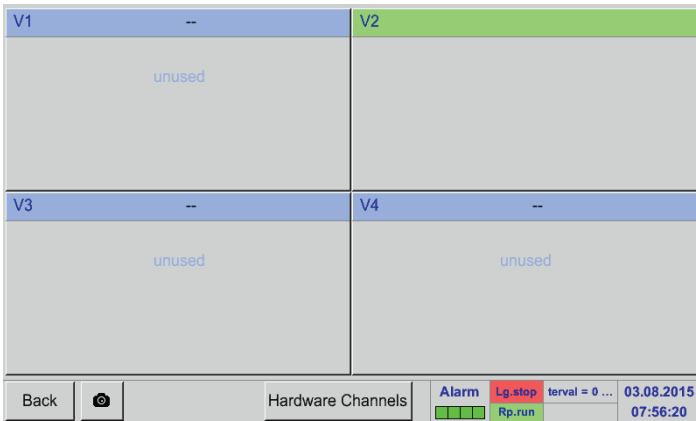

After the virtual channels have been activated, the 4 available channels are shown in the sensor settings menu.

Note:
By default, the channels are not preconfigured.

12.2.7.3. Selecting sensor type

Main menu ► Settings ► Sensor settings ► Virtual channels ► V1

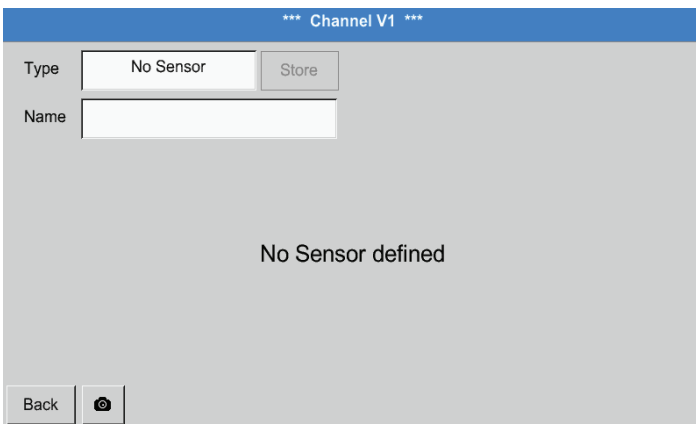

If no sensor has been configured yet, **No sensor** is displayed in the type field.

Touch the type field (reading **No sensor**) to call up a list of available sensor types (see next step).

Main menu ► Settings ► Sensor settings ► Virtual channels ► V1 ► Type

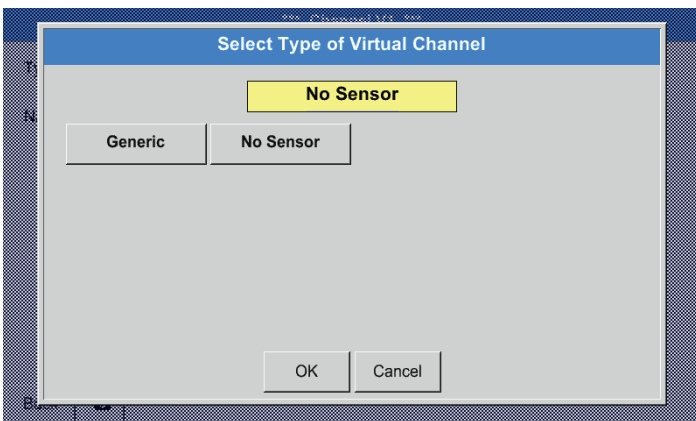

If no sensor has been configured yet, **No sensor** is displayed in the top field.

Pressing the **Generic** to select the virtual channel. Press the **No sensor** button to reset the channel.
Press the **OK** button to confirm the selection.

Main menu ► Settings ► Sensor settings ► Virtual channels ► V1 ► Name

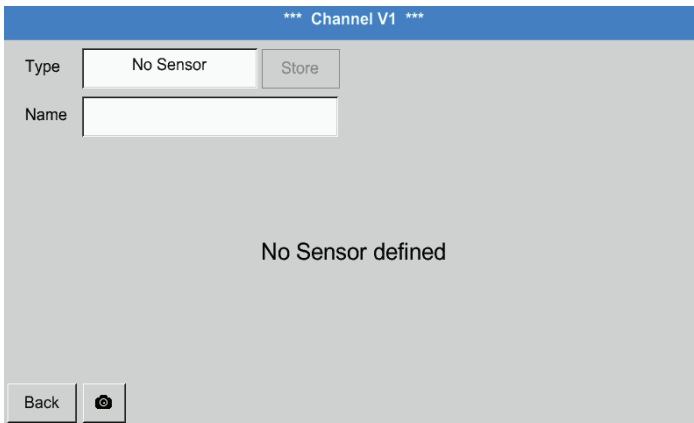

Enter a **Name** for the virtual channel.

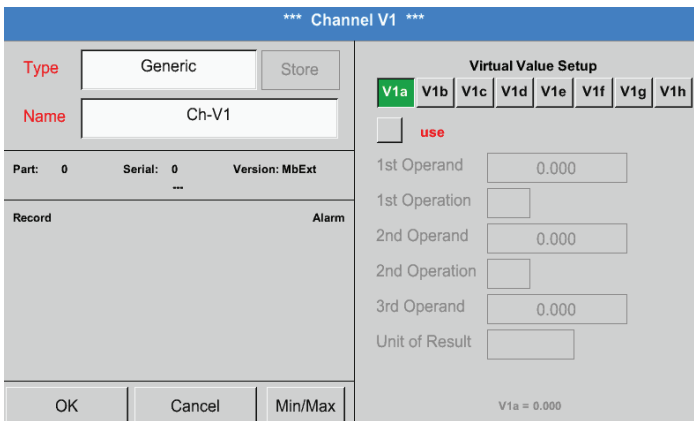

The **Save** button is intended for a future function and is currently **not** in use.

12.2.7.4. Configuring virtual values

For each virtual channel, up to 8 virtual values can be calculated. These values must be activated separately:

12.2.7.4.1. Activating virtual values

Main menu ► Settings ► Sensor settings ► Virtual channels ► V1 ► V1a ► use

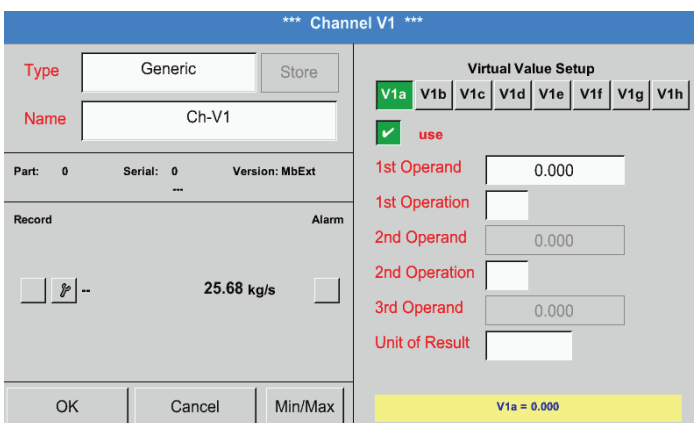

To activate a virtual value, press the respective **Value** button (e.g. **V1a**) and confirm with **OK**.

12.2.7.4.2. Defining operands

Main menu ► Settings ► Sensor settings ► Virtual channels ► V1 ► 1st operand

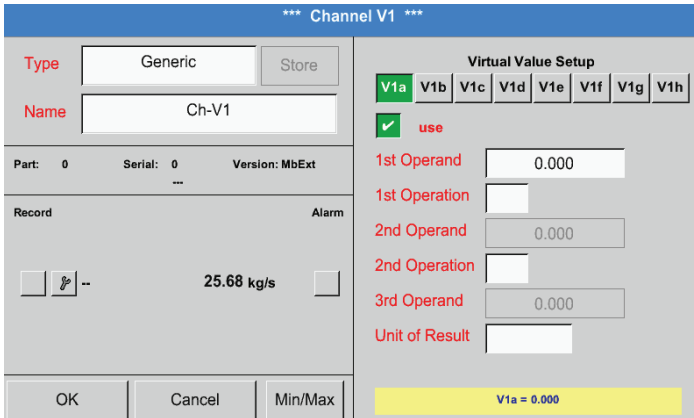

Touch the **1st operand** field. A list of the available hardware channels, virtual channels, and constant values is displayed.

Main menu ► Settings ► Sensor settings ► Virtual channels ► V1 ► 1st operand ► A1

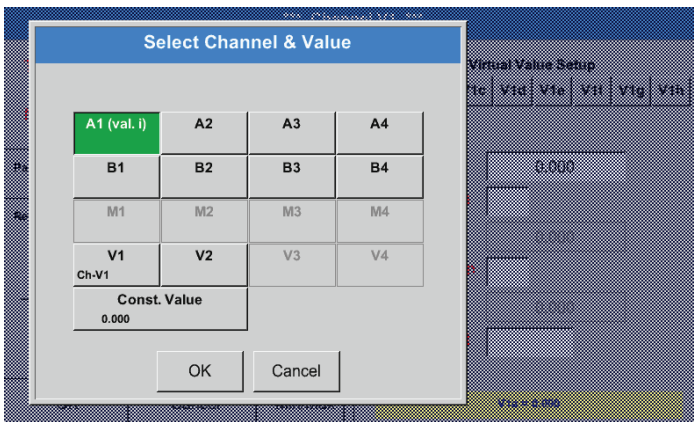

Press a hardware or virtual channel button (e.g. **A1**) to call up a list of the available measuring channels and measurements.

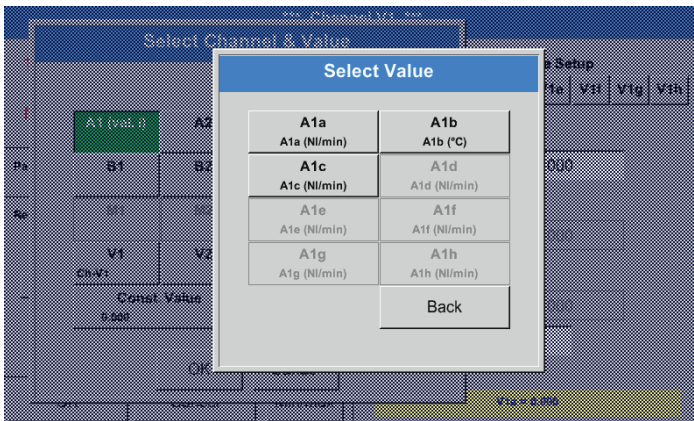

Press a channel button (e.g. **A1b**) to apply it.

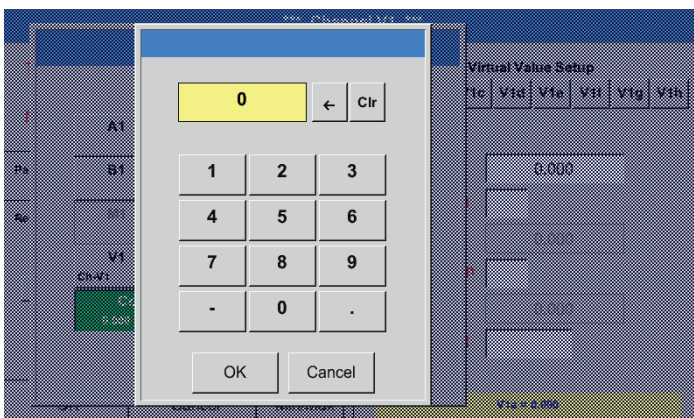

If the **Const. value** button has been pressed, enter the value in the field, using the numerical keypad. Press the **OK** button to apply the value.

To correct a value, press the ← or **Clr** button.

The ← button deletes the last character
The **Clr** button deletes the entire value

The procedure described here applies to all operands (1st operand, 2nd operand, and 3rd operand).

12.2.7.4.3. Defining operations

Main menu ► Settings ► Sensor settings ► Virtual channels ► V1 ► 1st operation

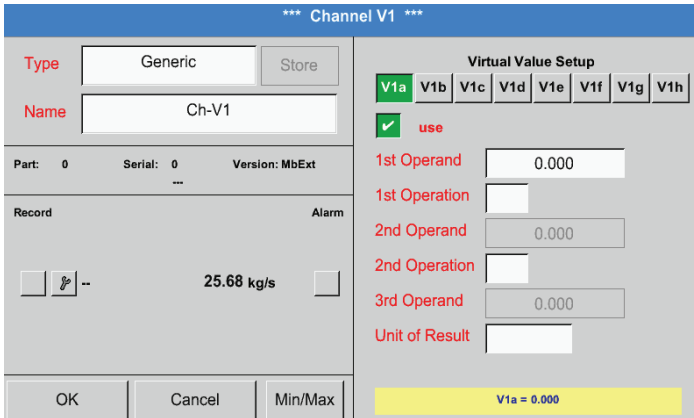

Touch the **1st operation**. The available mathematical operations are displayed.

Press the respective button to select and apply an operation.

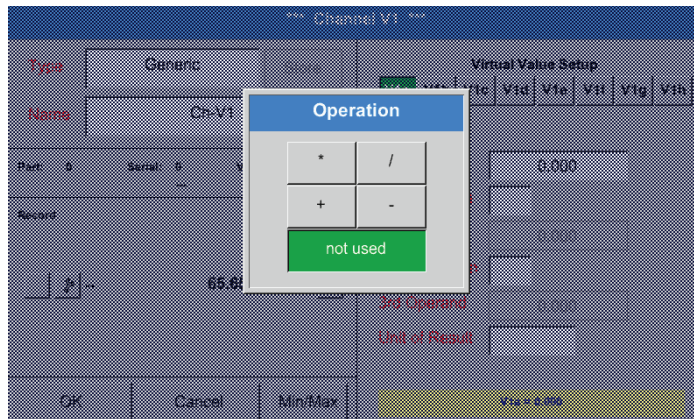

To reset a selected operation, press the **not used** button.

The procedure described here applies to all operators (1st operation and 2nd operation)

12.2.7.4.4. Defining unit

Main menu ► Settings ► Sensor settings ► Virtual channels ► V1 ► Unit for result

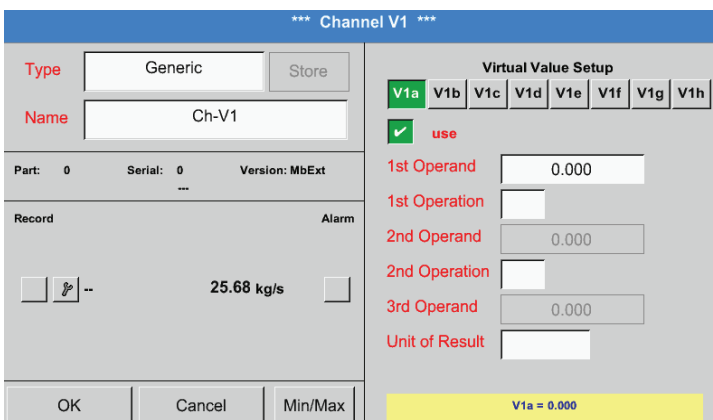

Touch the **Unit for result** field. The available units are displayed.

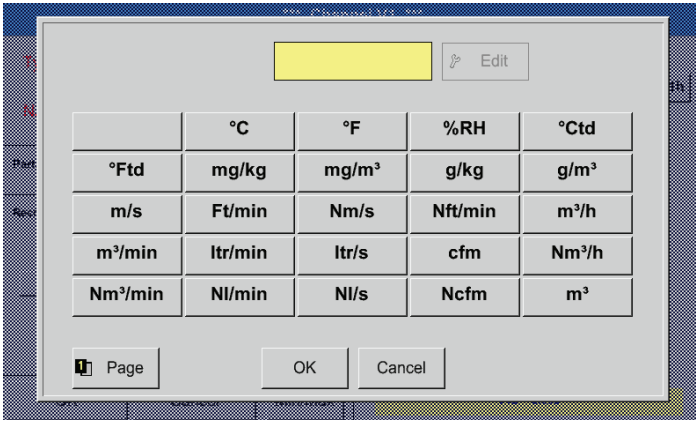

Select the unit by pressing the respective unit button. Press the **OK** button to apply the selected unit.
 To change between the individual list pages, press the **Page** button.
 If the required unit is not available, create it yourself.
 To do this, press one of the pre-defined **User_x** buttons.

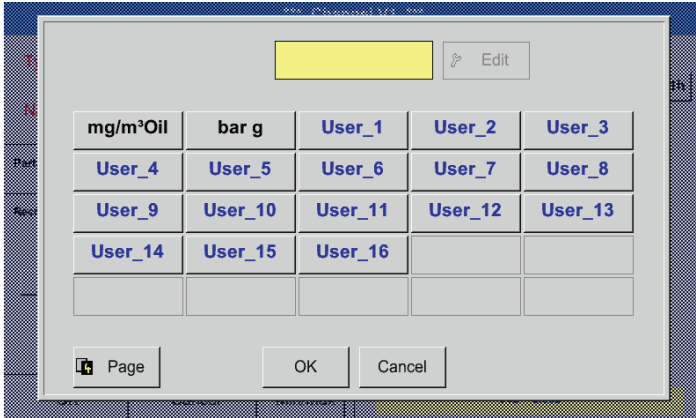

To enter the new unit, press the **Edit** button.

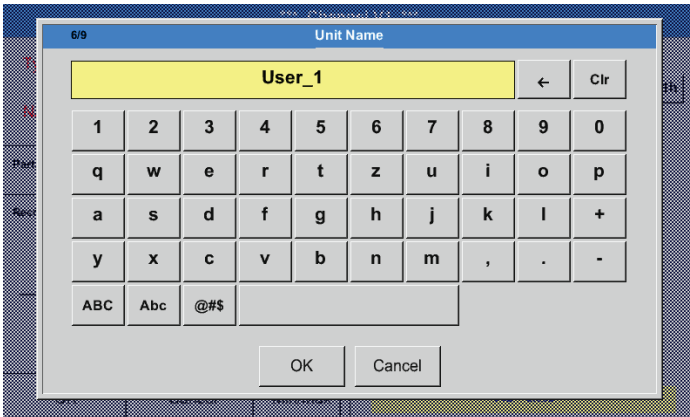

Enter the unit and accept with **OK**.

To correct an entry, press the **←** or **Clr** button.

The **←** button deletes the last character
 The **Clr** button deletes the entire value

Important:

After all values and operators have been entered, the system is able to perform calculations with 3 values and 2 operands as follows:

Example:

$$V1a = (1st\ operand\ 1st\ operation\ 2nd\ operand)\ 2nd\ operation\ 3rd\ operand$$

$$V1a = (A1c - A2a) * 4.6$$

12.2.7.5. Resolution of decimal places – labelling and recording data values

Main menu ► Settings ► Sensor settings ► Virtual channels ► V1 ► Tool button

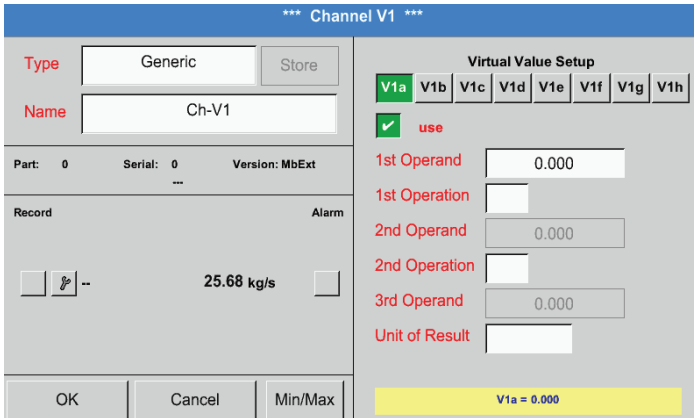

Press the **Tool** button to view the **Resolution** for decimal places, the **Short name** and the **Value name**.

Press the **Record** button to record and store the selected data on the activated data logger.

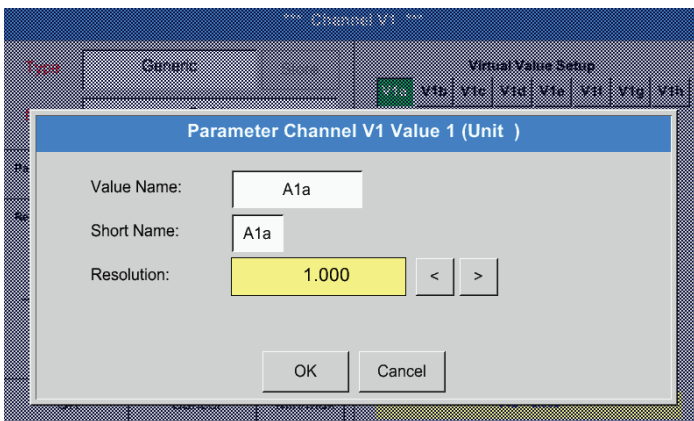

For the **Value** to be recorded, enter a **Name** with max. 10 characters. This name is then used in the **Charts** and **Chart/current values** menus. Otherwise, the default name (e.g. **V1a**) is displayed.

V1 indicates the channel; **a** is the first value in the channel, **b** would be the second, and **c** the third.

To adjust the **Resolution** of the decimal places, touch the arrow buttons (0 to 5 decimals places).

Main menu ► Settings ► Sensor settings ► Virtual channels ► V1 ► Record button

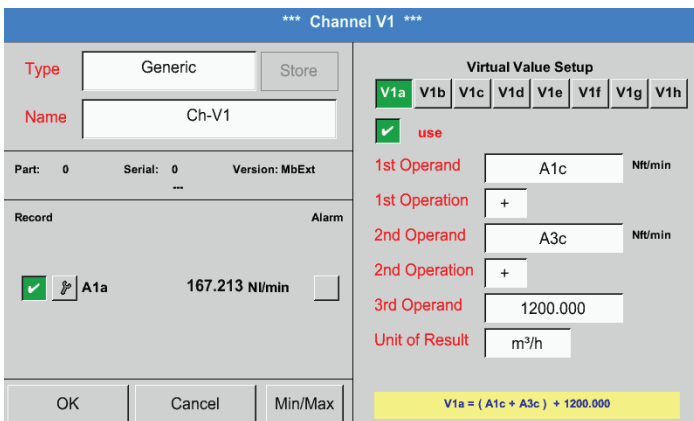

Press the **Record** buttons to select the measurements to be recorded and stored on the activated data logger.

Caution:

Prior to recording the selected measuring data, configure the data logger and then start it (see chapter 12.2.4 Logger settings (data logger)).

See also chapters 12.2.2.2 Labelling measurements and 12.2.2.3 Recording measuring data.

12.2.7.6. Example: calculation of "specific performance"

This example is based on a compressor plant with 5 compressors. The consumption is measured with an FS109 consumption probe at inputs A1 – A4 & B1, and an electricity meter at input B2.



The total consumptions for air and energy, and the "specific performance" of the entire plant are calculated.

Main menu ► Settings ► Sensor settings ► Virtual channels ► V1 ► V1a ► use

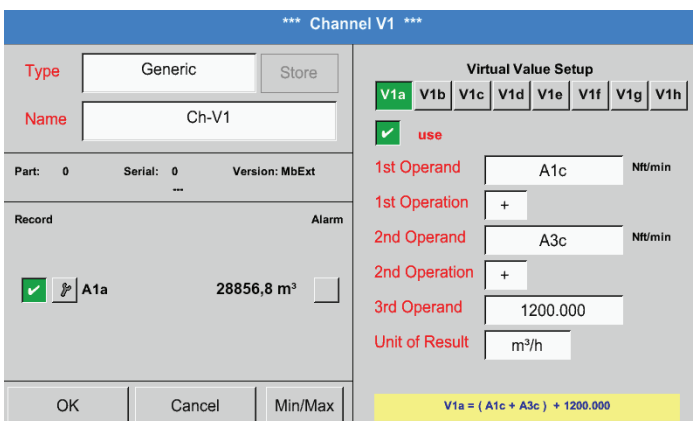

For instructions regarding the input of the operands and operations, see chapters 12.2.7.4.2 and 12.2.7.4.3.

The result for V1a is the sum of consumption sensors A1 + A2 + A3 (see result panel). In this example, it is 28856,8 m³

*** Channel V1 ***

Type: Generic [Store]

Name: Ch-V1

Part: 0 Serial: 0 Version: MbExt

Record Alarm

<input checked="" type="checkbox"/>	A1a	28856,8 m³	
<input type="checkbox"/>	--	37233,4 m³	

Virtual Value Setup

V1a V1b V1c V1d V1e V1f V1g V1h

use

1st Operand: A4a %RH

1st Operation: +

2nd Operand: B1a %RH

2nd Operation: []

3rd Operand: 0.000

Unit of Result: m³

V1b = A4a + B1a

OK Cancel Min/Max

For instructions regarding the input of the operands and operations, see chapters 12.2.7.4.2 and 12.2.7.4.3.

The result for V1b is the sum of consumption sensors A4 + B1 (see result panel). In this example, it is 37233,4 m³.

*** Channel V1 ***

Type: Generic [Store]

Name: Ch-V1

Part: 0 Serial: 0 Version: MbExt

Record Alarm

<input checked="" type="checkbox"/>	A1a	28856,8 m³	
<input type="checkbox"/>	--	37233,4 m³	
<input type="checkbox"/>	--	66090,2 m³	

Virtual Value Setup

V1a V1b V1c V1d V1e V1f V1g V1h

use

1st Operand: V1a mg/m³

1st Operation: +

2nd Operand: V1b mg/m³

2nd Operation: []

3rd Operand: 0.000

Unit of Result: m³

V1c = V1a + V1b

OK Cancel Min/Max

For instructions regarding the input of the operands and operations, see chapters 12.2.7.4.2 and 12.2.7.4.3.

The result for V1c is the sum of consumption sensors V1a + V1b (see result panel). In this example, it is 66090,2 m³. Alternatively, a total sum could be calculated in V1b, using the third operand in V1b: V1b = A4 + B1 + V1a -> not displayed

*** Channel V1 ***

Type: Generic [Store]

Name: Ch-V1

Part: 0 Serial: 0 Version: MbExt

Record Alarm

<input checked="" type="checkbox"/>	A1a	28856,8 m³	
<input type="checkbox"/>	--	37233,4 m³	
<input type="checkbox"/>	--	66090,2 m³	
<input type="checkbox"/>	--	4720,75 kWh	

Virtual Value Setup

V1a V1b V1c V1d V1e V1f V1g V1h

use

1st Operand: B2a ltr/min

1st Operation: []

2nd Operand: 0.000

2nd Operation: []

3rd Operand: 0.000

Unit of Result: kWh

V1d = B2a

OK Cancel Min/Max

The total consumed energy is shown in V1d.

This information is read from the electricity meter at input B2.

V1c → total compressed air consumption
V1d → power consumption

*** Channel V1 ***

Type: Generic [Store]

Name: Ch-V1

Part: 0 Serial: 0 Version: MbExt

Record Alarm

<input type="checkbox"/>	5.8		
<input type="checkbox"/>	Specific performance 0,072 kWh/m³		
<input type="checkbox"/>	Costs 991.36 €		

Virtual Value Setup

V1a V1b V1c V1d V1e V1f V1g V1h

use

1st Operand: B2a kPaa/h

1st Operation: /

2nd Operand: V1c kPaa/h

2nd Operation: []

3rd Operand: 0.000

Unit of Result: kWh/m³

V1e = B2a / V1c

OK Cancel Min/Max

The Specific performance is calculated as follows:
V1e = B2 / V1c = 0.072 kWh/m³

The costs are calculated as follows:
V1f = B2 * 0.21 = 991.36 €
As there are more than 4 values used in this virtual channel, the display is split onto two screens. To change between the screens, press the Page button.

12.2.8. Analog total (optional)

The "Analog total" option allows you to calculate the consumption based on sensors with analog outputs, e.g. 0-1/10/30 V or 0/4 – 20 mA.

12.2.8.1. Activating "Analog total" option

After having acquired the "Analog total" option, you must activate it.

Main menu ► Settings ► About BDL

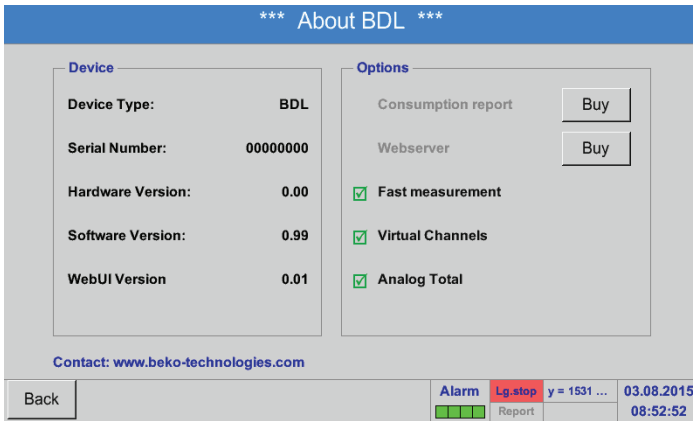

Press the **Buy** button for "Analog total". You are prompted to enter the activation code.

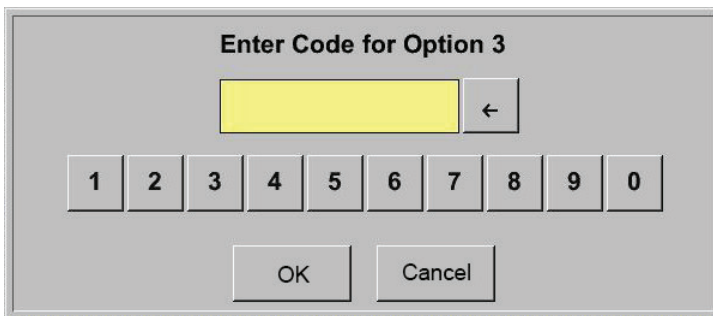

Enter your activation code and press the **OK** button.

12.2.8.2. Selecting sensor type

See also chapter 12.2.2.8 Configuring analog sensors

Main menu ► Settings ► Sensor settings ► A1

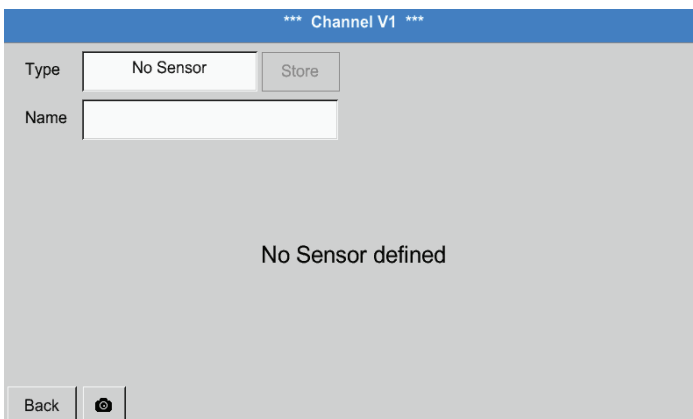

If no sensor has been configured yet, **No sensor** is displayed in the type field.

Touch the type field (reading **No sensor**) to call up a list of available sensor types (see next step).

Main menu ► Settings ► Sensor settings ► A1 ► Type

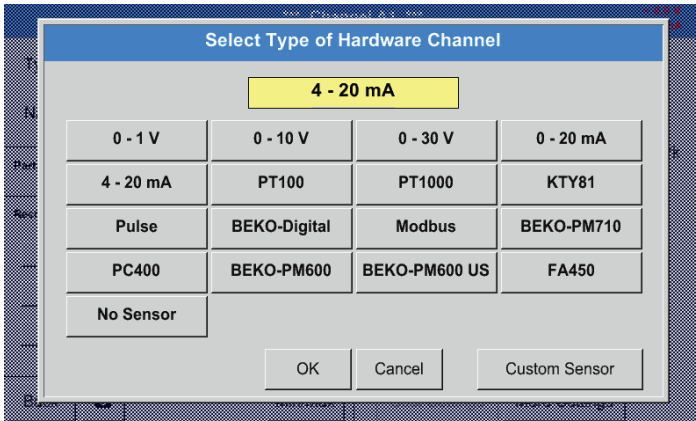

Select the required sensor type by pressing the respective button (here: 4-20 mA).

Confirm with **OK**.

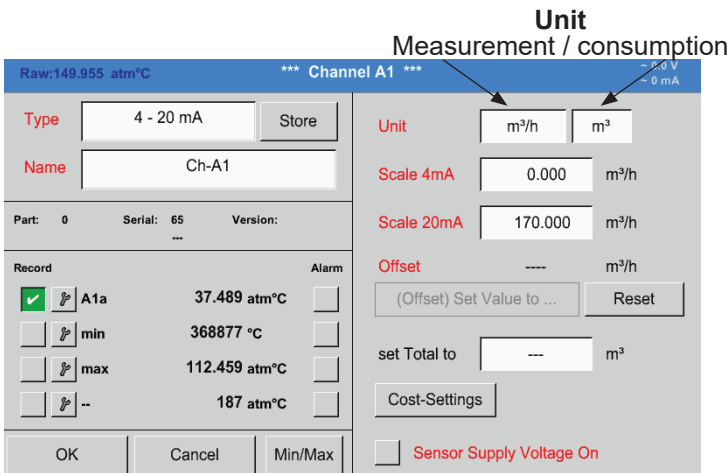

Select the units by touching the **Measured value** or **Consumption unit** field. Enter scaling values for 4 mA and 20 mA (here: 0 m³/h and 170m³/h). If required, enter the start value for consumption (counter value) in the **Set total to** field.

Confirm with **OK**.

Notice:

The "Consumption unit" field can only be edited, if the unit of the measurement is a consumption unit, i.e. unit for a volume over time.

For the labelling and configuration of the text fields, see chapter 12.2.2.7 Labelling and configuring text fields.

12.3. Charts

Main menu ► Charts

Caution:

Only recordings that are completed can be viewed in the form of charts!

Currently running recordings can be viewed with [Chart/current values](#) (see chapter 12.4 Chart/current values).

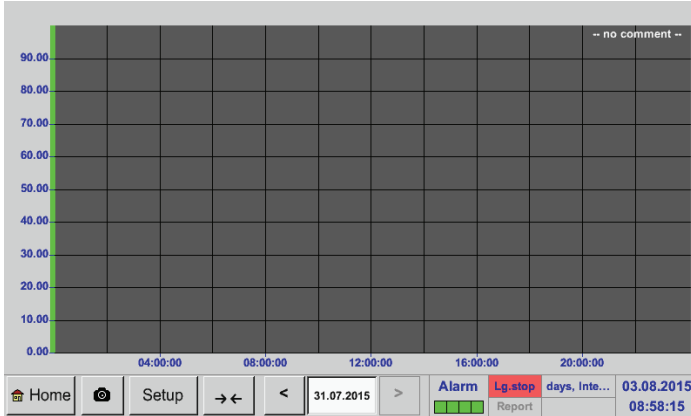

While a measurement is running, no values are displayed!

Zooming and scrolling in [Charts](#):



The maximum time period that can be viewed in a chart is 1 day (24h).



The shortest possible interval in the recording is displayed.

Additional zooming and scrolling options in [Charts](#) and [Chart/current values](#):

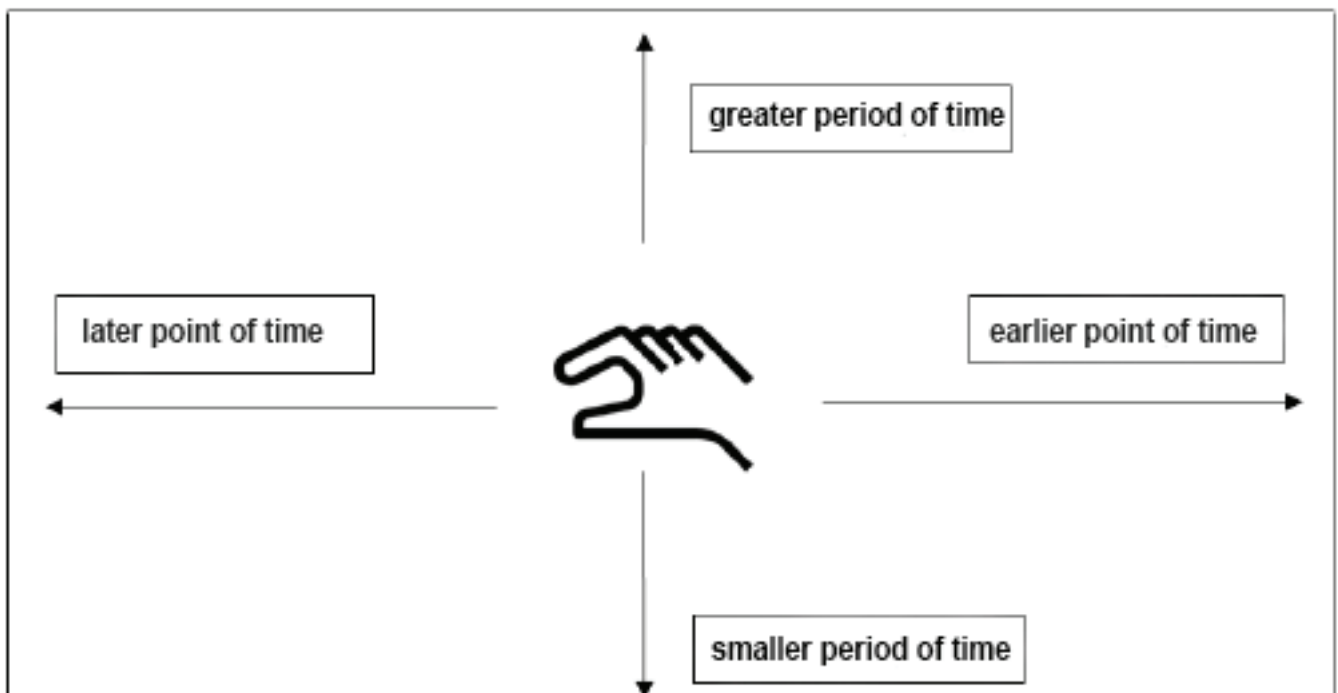

Main menu ► Charts ► Date

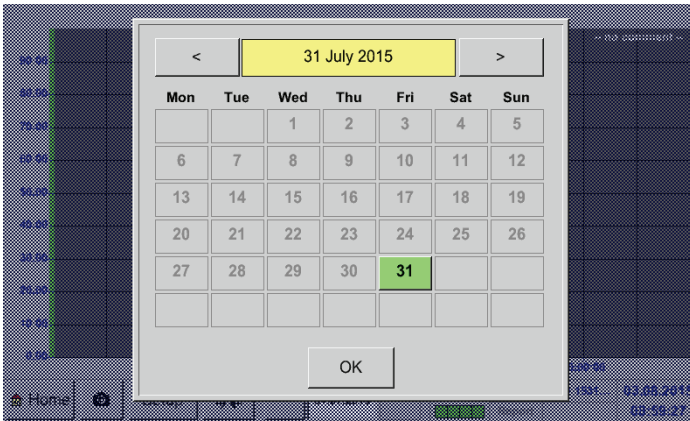

Press the **Date** field to call up a calendar where you can select the desired date.



Select saved measurements by **Time** (Start and Stop time), by **Comment** and/or by **File name** (contains date in UK format).

Main menu ► Charts ► Setup

In the setup menu, you can configure up to 4 y-axes and select the unit, the y-axis scale (min, max, grid), multiple channels (curves), and the colour to be displayed.

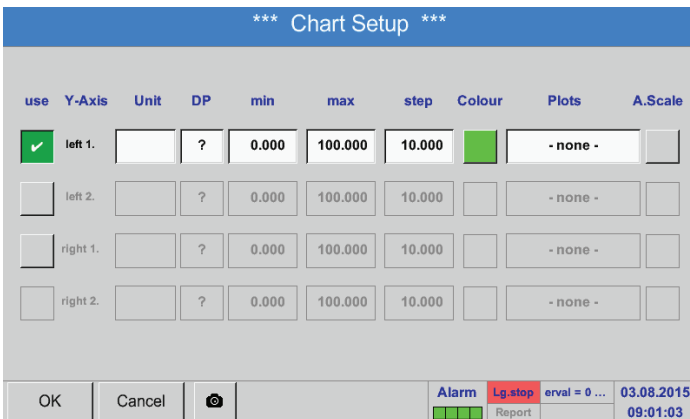

1. The **left 1.** y-axis is selected. You can now assign a **Colour** to it.

Notice: While the grid settings can already be made at this point, it is generally more useful to make them at a later stage, for instance after a recording has been selected!

Main menu ► Charts ► Setup ► Unit



2. Select the **Unit** of the recording to be displayed.

Main menu ► Charts ► Setup ► Curve

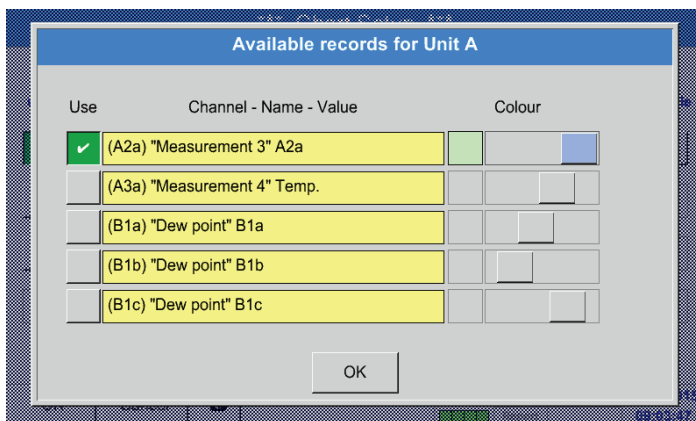

3. Select the recording and the **Colour intensity**.

Main menu ► Charts ► Setup

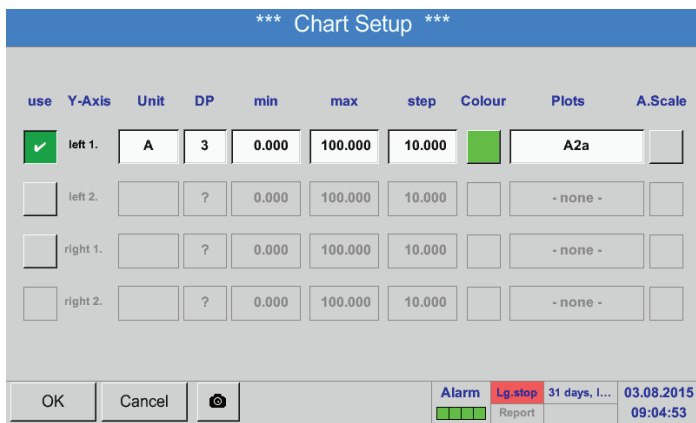

4. Select the y-axis scaling with **min.**, **max.** and **grid**.

Main menu ► Charts ► Setup ► Curve

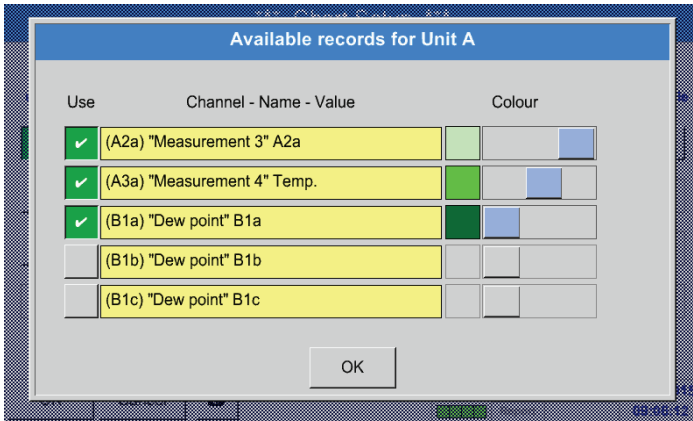

5. It also is possible to view multiple recordings with the same unit along the y-axis, using different colour intensities.

Main menu ► Charts ► Setup

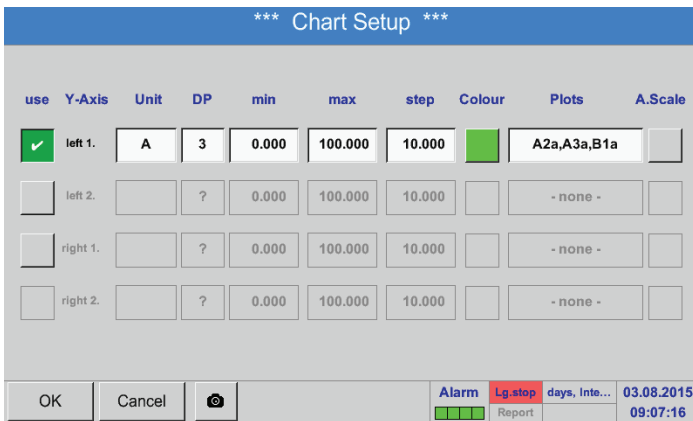

6. The Curve field shows the channel on which the measurements were recorded. It also indicates how many recordings are being displayed along one y-axis.

To configure the other y-axes, proceed as described above!

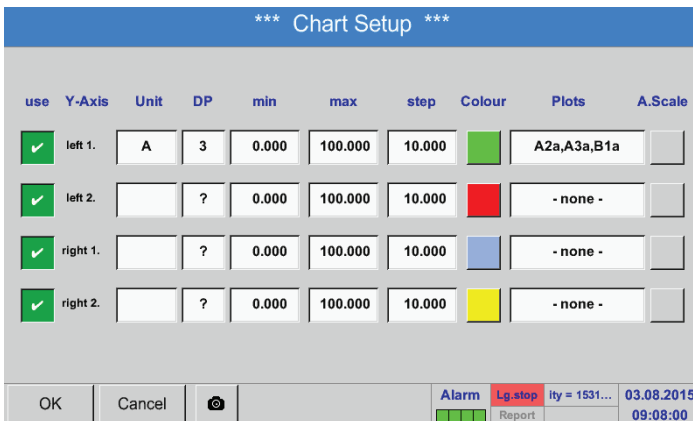

Four different grid settings with different Units and Colours.

Main menu ► Charts

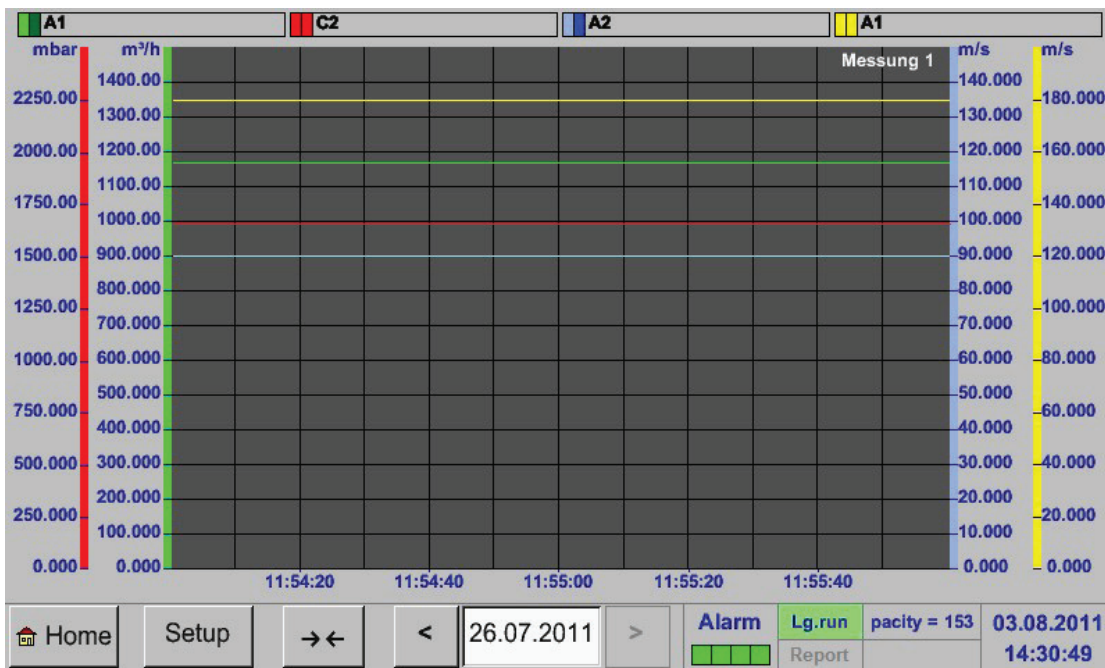

12.4. Chart/current values

Main menu ► Chart/current values

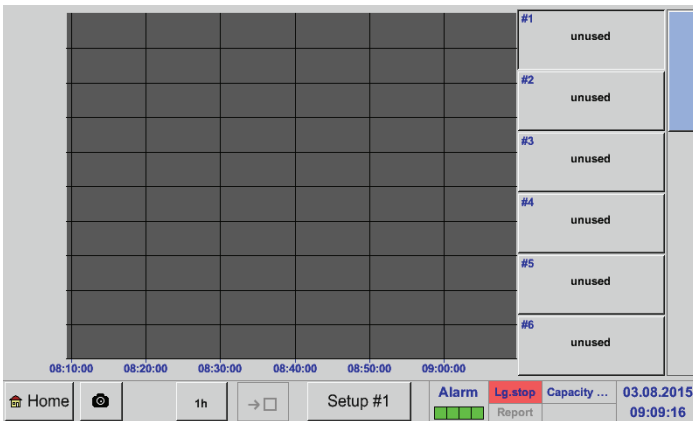

One or more channels for the recording and the visualisation of the measurements can be selected here (e.g. on dew point sensor or a number of different sensors).

Main menu ► Chart/current values ► Setup #1- #12

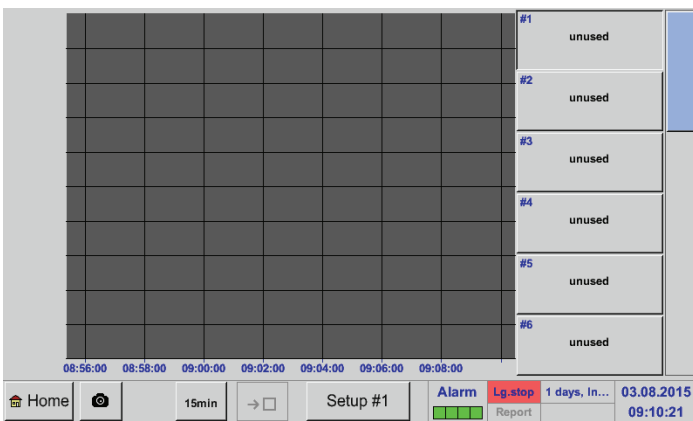

Select this menu option to simultaneously activate and view up to 12 channels (depending on your BDL version).
Main menu → Chart/current values.

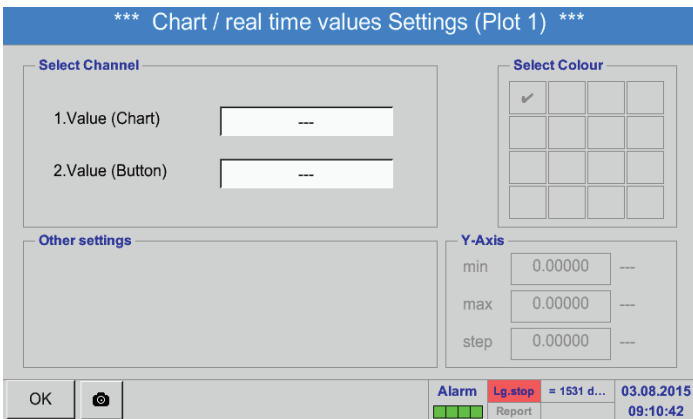

Here: channel A1 has been selected. For each channel, select a value ("Chart") for visualisation in the chart, and one value to be displayed (2nd value).

In addition, you can define the y-axis scaling factors (as described in Main menu → Charts, a Colour: min, max, grid).

Main menu ► Chart/current values

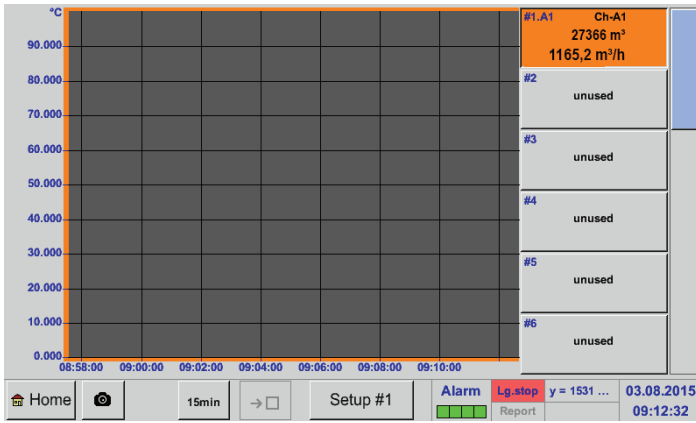

Channel A1:

In the example, the flow volume has been selected for the Chart and the consumption as the 2nd value (numeral in small font).

The selected channel colour is orange.

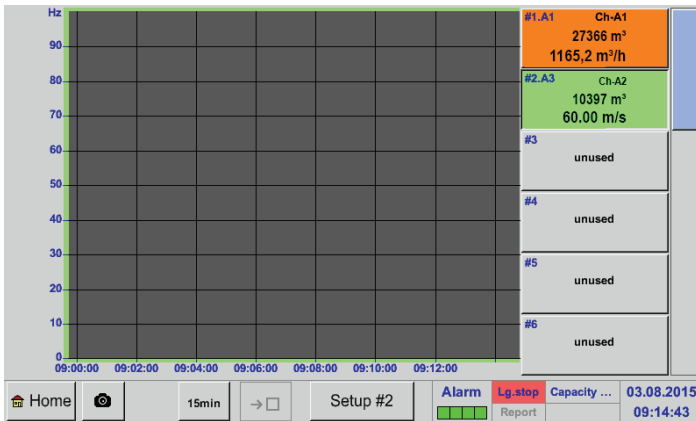

If more than one channel has been selected (here: 2 channels), all related charts are displayed. Please note that only the y-axis of the selected channel is displayed (here: Setup #2).

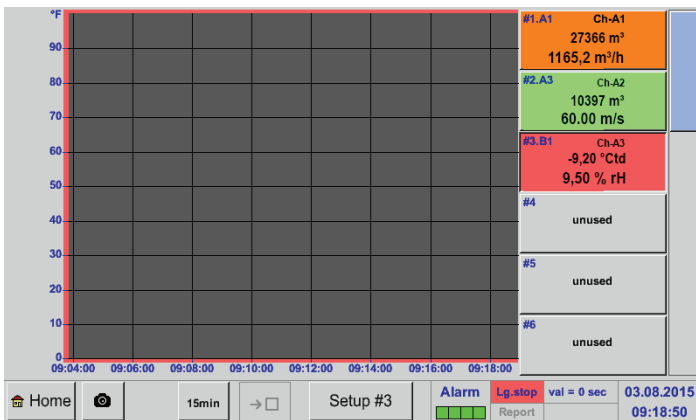

When no y-axis scaling is entered in the setup, min. is set to 0, max. is set to 100, and grid is set to 10 (setup #3).

Proceed as described above to configure all other setups!

12.5. Current values

Main menu ► Current values

A1		Ch-A1		A2	A3	A4		
<input checked="" type="checkbox"/>	A1a	57.202 mV			A3a 172 mV			
	min	562848 °C	A2a	114 mV	A3b 229 mV	A4a 229 mV		
	max	171.603 mV			A3c 286 mV			
	--	286 mV						
B1		B2		B3	B4			
	B1a	286 mV	B2a	343 mV	B3a	400 mV	B4a	458 mV
	B1b	343 mV	B2b	400 mV	B3b	458 mV	B4b	515 mV
	B1c	400 mV	B2c	458 mV	B3c	515 mV	B4c	572 mV

The **Current values** menu shows the current measurements of all the connected sensors. If a set alarm limit has been exceeded, the respective measured value flashes in yellow (**Alarm 1**) or red (**Alarm 2**).

Main menu ► Current values ► A1

*** Channel A1 ***

Type: 4 - 20 mA Unit: m³/h | m³

Name: Ch-A1 Scale 4mA: 0.000 m³/h

Part: 0 Serial: 65 Version: ... Scale 20mA: 170.000 m³/h

Record: A1a 57.740 Nm³ Alarm

min 568137 °C

max 173.216 Nm³

-- 289 Nm³

Offset: ---- m³/h

(Offset) Set Value to ... Reset

set Total to: --- m³

Cost-Settings

Sensor Supply Voltage On

Back Min/Max

You have the option to select a channel to call up and check the settings. It is however not possible to change the settings here.

Notice:
Changes to the settings must always be made in the **Settings** menu!

12.6. Alarm overview

Main menu ► Alarm overview

*** Alarm relay overview ***

	A1	A3	B1	B3	M1	M3	V1	V3
	Ch-A1						Ch-V1	
Relay 1								
Relay 2								
Relay 3								
Relay 4								
	A2	A4	B2	B4	M2	M4	V2	V4

■ = Alarm 1 ■ = Alarm 2/Alarm 1

■ = Alarm ■ = Lg. stop ■ = pacity = 1...

■ Report 03.08.2015 09:24:46

In the alarm overview, you can immediately see whether the alarm is an **Alarm 1** or an **Alarm 2**. The type of the alarm is also shown in other menu:
 Main menu ► Current values and in Main menu ► Settings ► Sensor settings
 The channel name field flashes in yellow for an **Alarm 1** and red for an **Alarm 2**.
 In addition, the relays that have been set for the channels for Alarm 1 and/or Alarm 2 are indicated by yellow and red or red/yellow squares at the intersections between the measuring channel and the relays.

In the example, there is an **Alarm 1** at channel A3 and an **Alarm 2** at channel A4!

Main menu ► Alarm overview ► A1

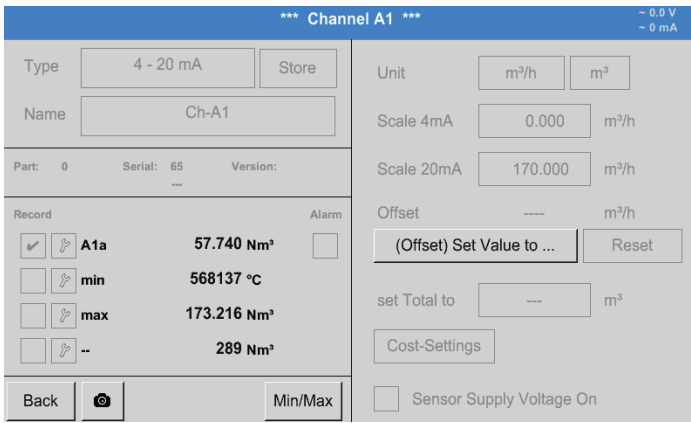

As in **Main menu ► Current values**, you can select an individual channel.

In the **Alarm overview**, the measurement that has triggered the alarm can be quickly identified.

Notice:

In this menu, you can set and edit the alarm parameters.

12.7. Other settings

12.7.1. Brightness

Main menu ► Settings ► Brightness

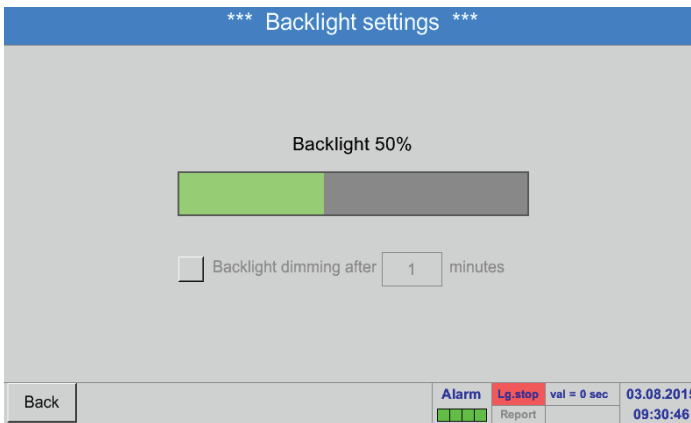

In this menu, you can adjust the **Brightness** of the display (15 ... 100%).

Example: **Brightness** set to 50%

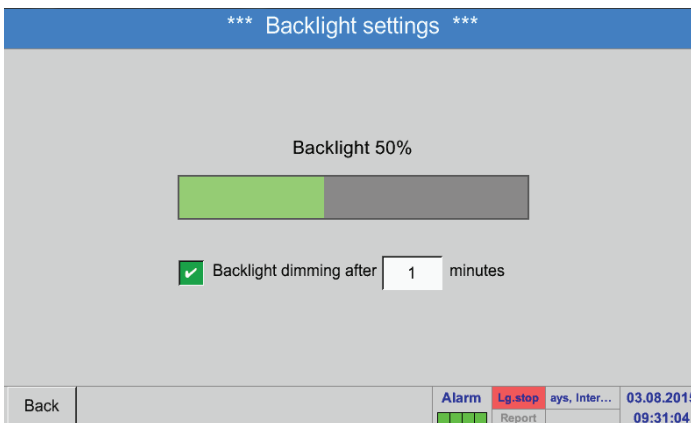

Check the **Dim after** box to reduce the brightness to a minimum after the set time interval has elapsed (here: 15 minutes).

As soon as the dimmed screen is activated again, the **Brightness** automatically returns to the last set value (prior to dimming).

Notice:

When the display is touched again, the **Brightness** returns to 50%. Subsequently, the bar works like a normal slider bar.

Important:

If the **Dim after** box is not checked, the panel remains backlit with the currently set **Brightness**.

12.7.2. Calibrating touch screen

Main menu ► Settings ► Touch screen calibration

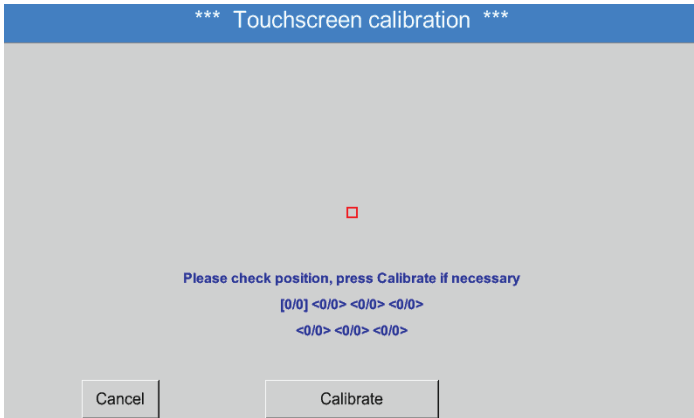

If required, the touch screen calibration can be changed.

Press the **Calibrate** button. A calibration cross appears, first in the top left corner, then in the bottom right corner and finally at the centre of the display. Touch these crosses one after the other. After calibration has been completed and the display has been properly centred on the screen, confirm with **OK**.

If the display is not centred, repeat the calibration process by pressing the **Cancel** button and then pressing the **Calibrate** button.

12.7.3. Cleaning

Main menu ► Settings ► Cleaning



This function can be used to clean the touch screen while measurements are running. The screen is temporarily disabled for 60 seconds.

If 60 seconds are not sufficient for cleaning, restart the function.

If cleaning is completed before the 60 seconds have elapsed, press and hold the **Press and hold to abort** button for one to two seconds.

NOTICE	Cleaning
	For more information regarding the cleaning of the touch screen, see chapter 13

12.7.4. System overview

Main menu ► Settings ► System overview

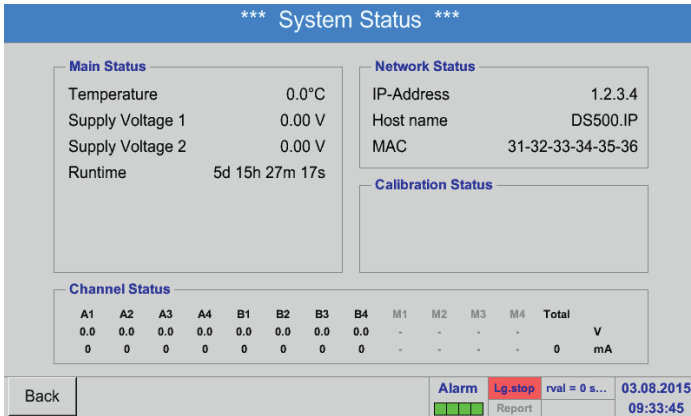

The **System overview** menu provides information on the applied voltages and currents of the individual **Channels**, as well as on the voltage supply of the power supply units. In addition, the most important network parameters such as **IP**, **Host** and **MAC** are displayed. In addition, the total **Operating hours** of the BDL are displayed.

12.7.5. About BDL

Main menu ► Settings ► About BDL

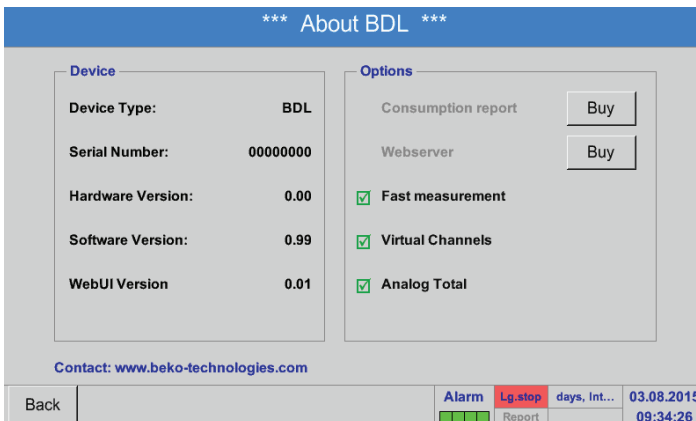

The **Hardware version**, the **Software version**, and the **Serial number** of the BDL are displayed.

The **Options** panel shows the optional functions that can be ordered.

12.8. Report/consumption analysis with costs – exporting data

The optional **Report** function allows you to calculate and call up daily, weekly, monthly, and annual total consumption figures.

The currency is entered in the **Report settings** (see chapter 12.2.6 Report settings (optional)). The consumption costs, at a set point in time, are entered as described in chapter 12.8.2 Costs (optional).

The optional **Web server** function enables you to view the current BDL values from anywhere in the world.

12.8.1. Report/consumption analysis (optional)

Main menu ► Report

Week	<no report>					Total
	Consumption per week m³/h	Costs	min value m³/h	max value m³/h	average m³/h	
2015 Week 31						
2015 Week 32						
2015 Week 33						
2015 Week 34						
2015 Week 35						
2015 Week 36						
2015 Week 37						
2015 Week 38						
2015 Week 39						
2015 Week 40						

Home [Camera] Day/Week Week Month/Year < >

When the Report menu is called up, the weekly overview is automatically displayed.

Notice:

The Costs refer to the set channel (here: A1). The last column shows the total costs of all channels that are included in the calculation overall, the costs of all the registered channels can be found.

Main menu ► Report ► Day/week

Day/Week	<no report>					Total
	Consumption per day m³/h	Costs	min value m³/h	max value m³/h	average m³/h	
27.07.2015 Mon						
28.07.2015 Tue						
29.07.2015 Wed						
30.07.2015 Thu						
31.07.2015 Fri						
01.08.2015 Sat						
02.08.2015 Sun						
Total Week 31						
03.08.2015 Mon						
04.08.2015 Tue						

Home [Camera] Day/Week Week Month/Year < >

Press the respective buttons to compile a daily or weekly Consumption analysis.

Main menu ► Report ► Month/year

Month/Year	<no report>					Total
	Consumption per month m³/h	Costs	min value m³/h	max value m³/h	average m³/h	
2011 January						
2011 February						
2011 March						
2011 April						
2011 May						
2011 June						
2011 July						
2011 August						
2011 September						
2011 October						

Home [Camera] Day/Week Week Month/Year < >

Also available are a monthly and an annual Consumption analysis.

Touch screen operation for reporting

With the **Report** function, you can view consumption and cost figures of a channel for any chosen time period or date on the touch screen.

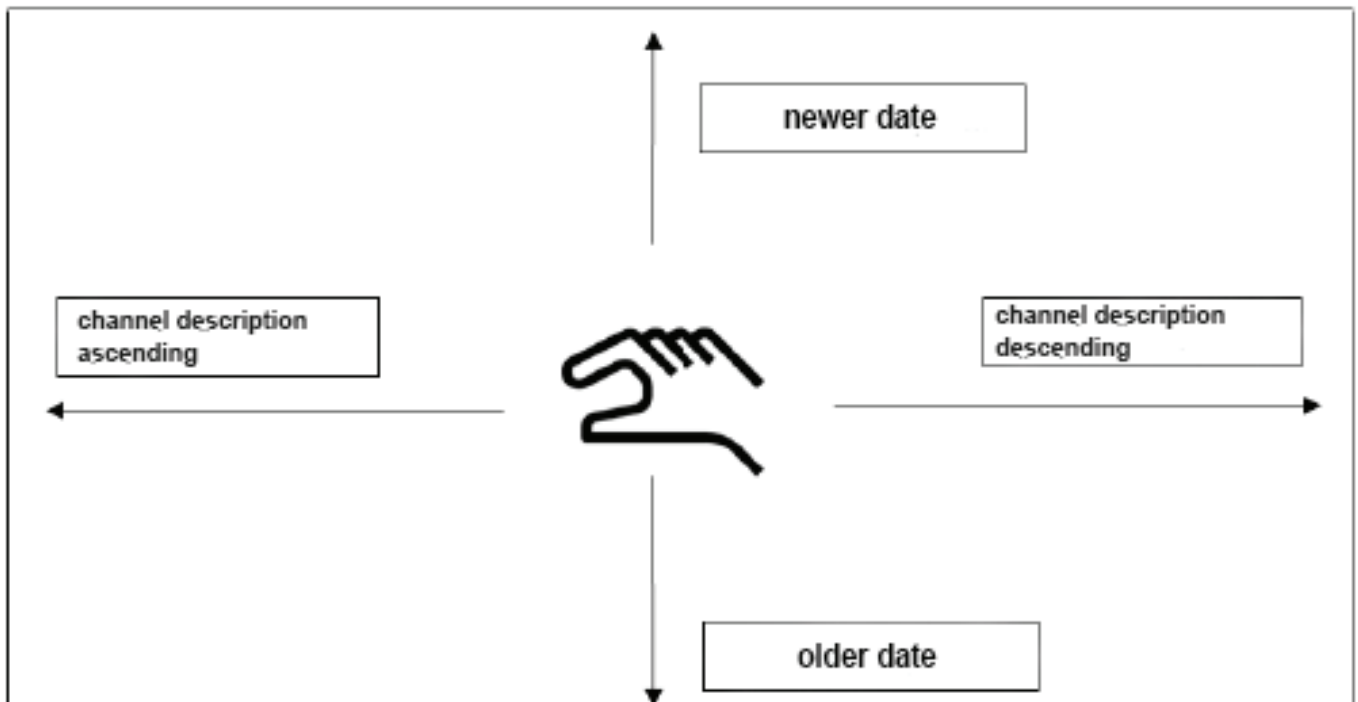

Note: The selected channel is displayed in green on the **Report** screen!

12.8.2. Costs (optional)

Main menu ► Settings ► Sensor settings ► A1 ► Costs

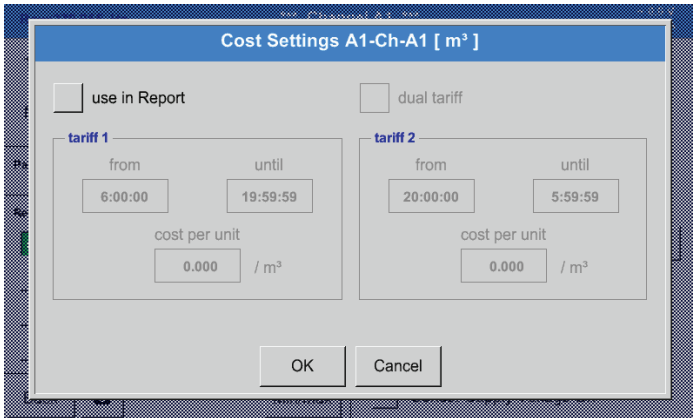

For Type **BEKO Digital** and **pulse** the costs can be entered in the **Costs** menu in the **Sensor settings**.

Main menu ► Settings ► Sensor settings ► A1 ► Costs ► Include in consumption analysis box

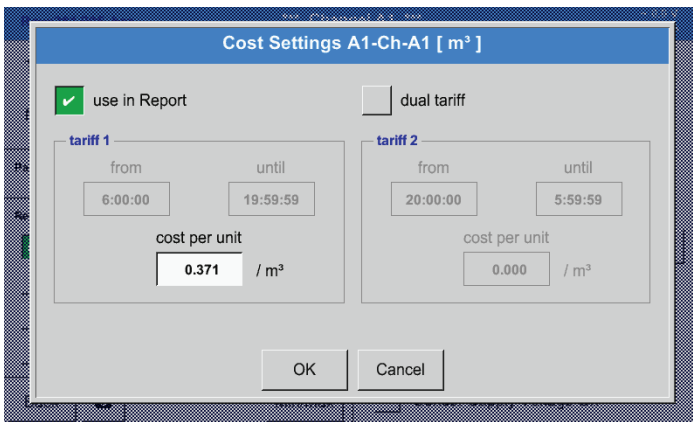

Enter the consumption costs per unit for a specific tariff.

Main menu ► Settings ► Sensor settings ► A1 ► Costs ► Include in consumption analysis box and Dual tariff box

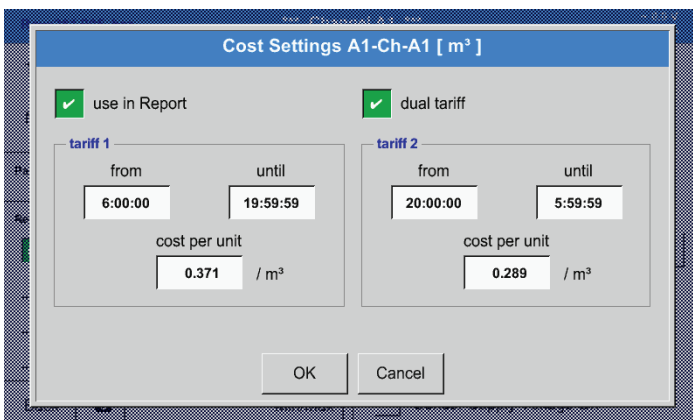

You have for example the option to enter day-time and night-time tariffs and the relevant switching times.

For instructions on how to label the text fields, see chapters 12.2.2.7 Labelling and configuring text fields and 12.2.4 Logger settings (data logger).

12.9. Web server (optional)

The METPOINT® BDL data logger can be operated in conjunction with an optional web server that provides a graphic user interface. The web server allows for remote configuration of the device, and all measuring data and system information can be accessed from anywhere in the world.

The web server provides the following functionalities:

- Reading and analysis of measurements
- Display of system information
- Automatic e-mail alerts in the event of alarms (limit exceedances)
- Starting/stopping data logger
- Configuration of METPOINT® BDL

12.9.1. Activating web server

The web server services are subject to a fee and must be activated before they are available. When ordering the web server, quote the serial number of the METPOINT® BDL (1) and the serial number on the type plate (2). You then receive the activation code.

Main menu ► Settings ► About BDL

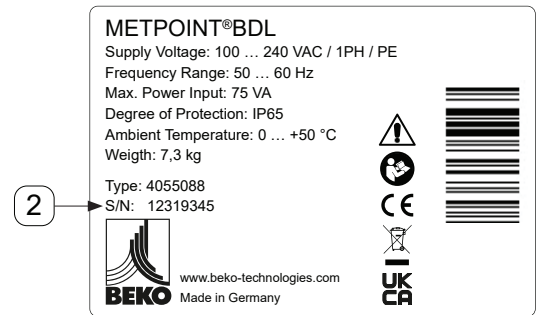
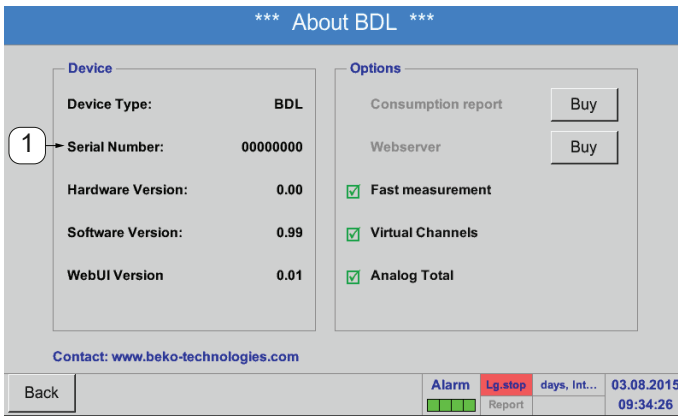

To activate the web server, touch the >>Buy<< button and enter the activation code.

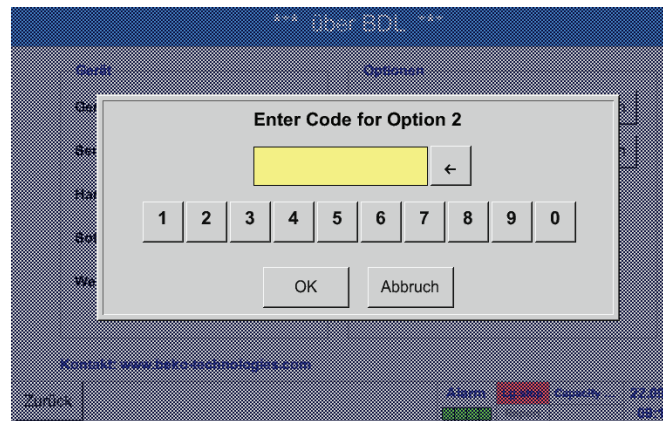
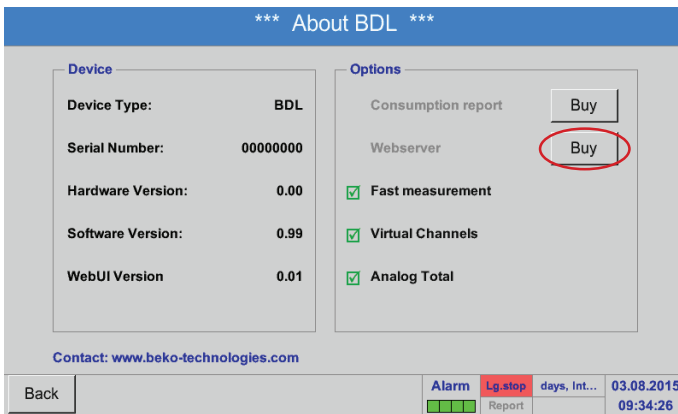

12.9.2. Web server configuration

12.9.2.1. Network settings

To access the web server, the BDL must be integrated into the network. The web server can be assigned a static IP address. With a DHCP server, use the automatically assigned IP address.

Network settings at BDL:

Main menu ► Settings ► Device settings ► Network settings

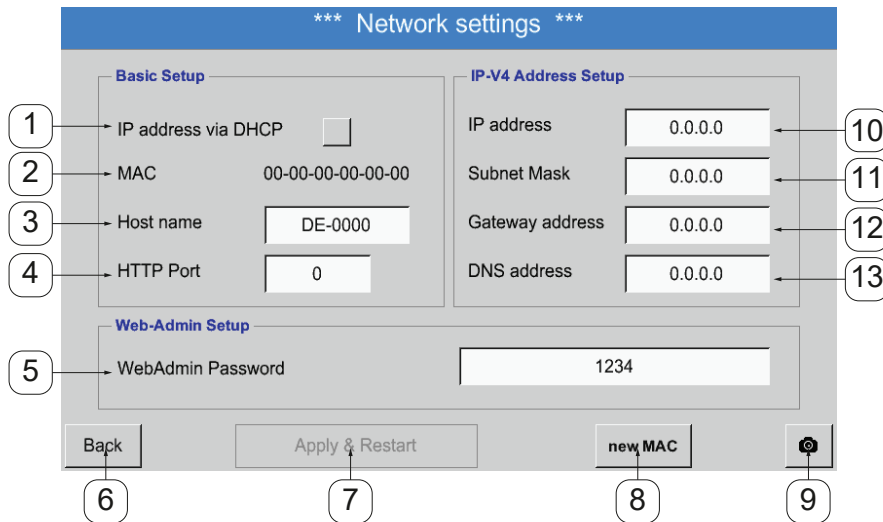

No.	Description
1	Check box for automatic IP address assignment by DHCP server. If this box is checked, the IP address fields for manual input (10), (11), (12), (13) are disabled.
2	MAC address of web server
3	Host name/network name of web server
4	HTTP port of web server
5	Administrator password for login to web server
6	Back to >>Device settings<< menu. All entries made are ignored.
7	Apply changes and restart METPOINT® BDL
8	Assign new MAC address to web server
9	Takes a screenshot of the current configuration settings. This screenshot can be saved to an USB memory stick or the SD card of the METPOINT® BDL.
10	IP address of web server (enter only if no DHCP server is used)
11	Subnet mask of web server (enter only if no DHCP server is used)
12	Gateway address of web server (enter only if no DHCP server is used)
13	DNS address of web server (enter only if no DHCP server is used)

NOTICE	Enabling remote access
	To enable remote access to the web server from outside the network, you might need to change the firewall settings and set up a VPN connection.

12.9.3. User interface

The user interface can be called up with any conventional web browser. To call up the user interface, enter the IP address of the web server in the address bar of the web browser (e.g. **http://172.16.4.56**). The start page is the information page.

12.9.3.1. Information

This page shows all relevant system information of the METPOINT® BDL in the form of a table.

The screenshot shows the BEKO BDL web interface. At the top, there is a header with the BEKO logo, the text "BDL the quality of your compressed air", and user information: "18.3.2016 - 09:22:30 Visits: 11 User: admin Logout in: 8:34". Below the header is a navigation menu with options like "Info", "Favourites", "Status", "Actuals", "Screen", "Chart", "MailOnAlarm", "Users/Passw.", and "EMail Config". The main content area is titled "System Information" and contains a table with the following data:

System Information	
Brandname	BDL
Company	BEKO TECHNOLOGIES
Serialnumber	06140407
Hardware Version	V0.00
Software Version	V4.07
Channel Version	V0.05
Language Version	V1.66
WebUI Version	V1.06
Total Channels	12
Hostname	BDLHQBEC
Calling IP	172.16.26.141
Logger State	run
Alarm State	OK

Designation	Description
Series/brand name	Device product name
Company	Device manufacturer
Serial number	Serial number of device
Hardware version	Current hardware version
Software version	Current software version
Channel version	Current channel version
Language version	Current language versions
WebUI version	Current version of web interface (WebUserInterface)
Total number of channels	Number of available channels at METPOINT® BDL
Host name	Network name of METPOINT® BDL – see also chapter 12.9.2.1, page 105
Called from IP	IP address of PC from which the web server is accessed
Logger status	Current status of data logger
Alarm status	Current alarm status

12.9.3.2. Selecting language

The web server user interface language is factory-set to German. If required, choose a different language from the dropdown list ¹.

The screenshot shows the BEKO BDL web interface with the language selection dropdown menu open. The dropdown list contains "1" and "english". The main content area shows the "System Information" table with the first row visible: Brandname: BDL.

Available languages:

- German
- English

NOTICE	Restriction of access
	<p>Access to certain menu options is restricted. To have read and write access to all settings, you must log in ² as Administrator and enter the password specified in 12.9.2.1, page 105 (e.g. 1234).</p> <p>For the configuration of additional users, call up the User menu, see chapter 12.9.10.1, page 112.</p>

12.9.4. Login

To log in to the web server, press the >>Login<< ① button.

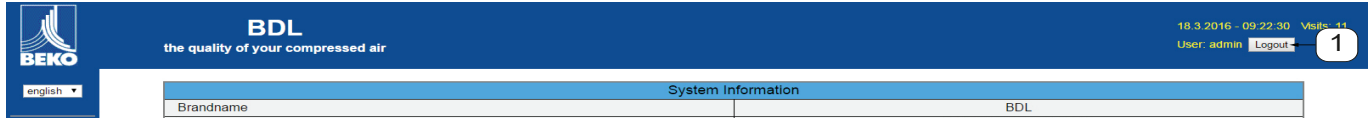

To be read and write access to all settings, you must log in as **Administrator**.

Login

Username

Password

User name: admin
 Password: e.g. 1234 → see 12.9.2.1, page 105

NOTICE	Restriction of access
	For the configuration of additional users and access rights, call up the User menu, see chapter 12.9.10.1, page 112.

12.9.5. Favourites

This menu provides access to 4 user-defined web pages (favourites) that can be configured for the display of measurements. This menu is accessible without prior login.

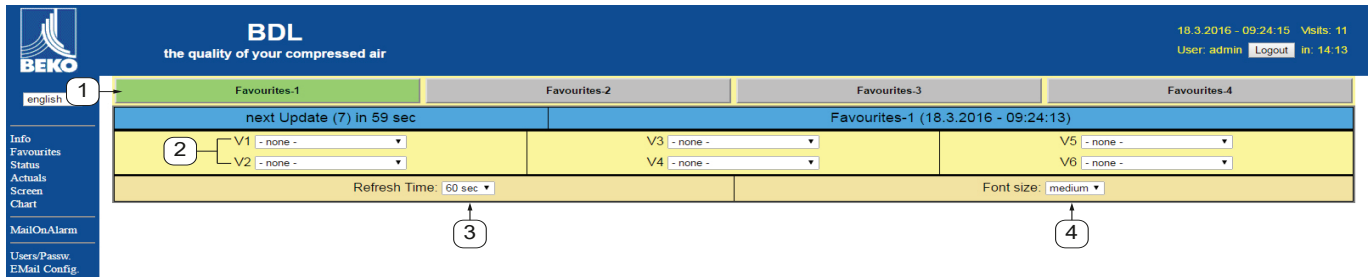

No.	Description
①	Select user-defined page (favourite)
②	Select channels and measurements to be displayed
③	Select update interval for display
④	Select font size for measurements

12.9.6. Status

The status menu shows the statuses of the individual relays and the data logger.

12.9.7. Current value

This menu shows the current measurements transmitted by the connected sensors. You have the option to narrow the overview down to selected sensors and measurements.

No.	Description
1	Select sensors to be displayed
2	Select measurements to be displayed
3	Select update interval for display
4	Select font size

12.9.8. Display

The menu shows the current METPOINT® BDL GUI and enables you to configure the BDL. The display is automatically updated every 60 seconds. It is thus not a real-time display.

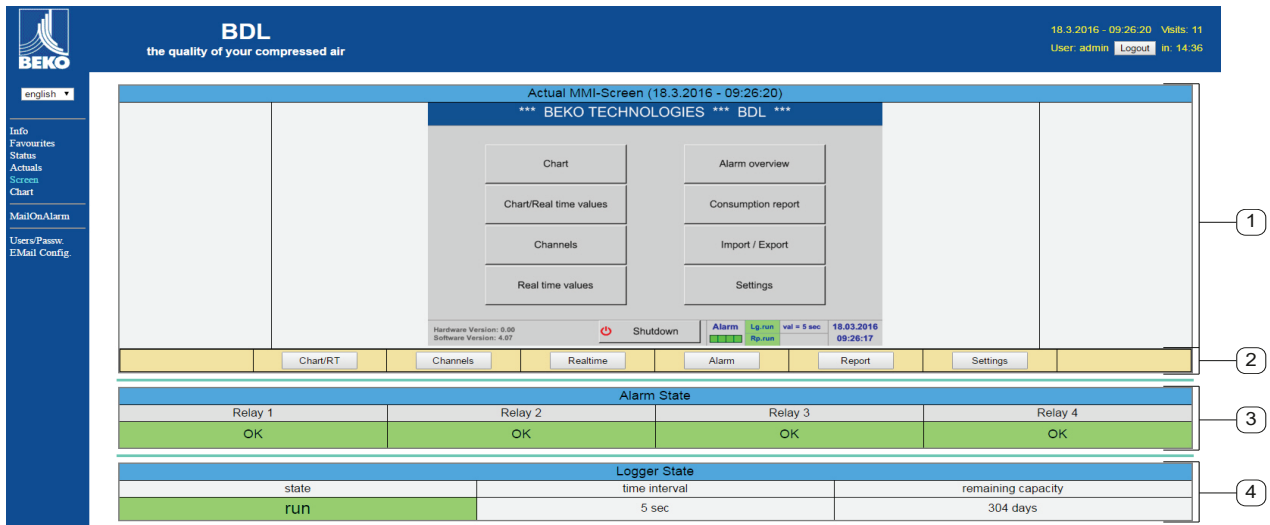

No.	Description
1	Current METPOINT® BDL touch screen display
2	Buttons for the operation and configuration of the METPOINT® BDL
3	Current alarm status of relays
4	Current status of data logger

Press the buttons 2 to change the settings as if you were operating the BDL on site.

12.9.9. Chart

This menu is used to view charts. All measurements stored on the SD card can be displayed in the form of charts.

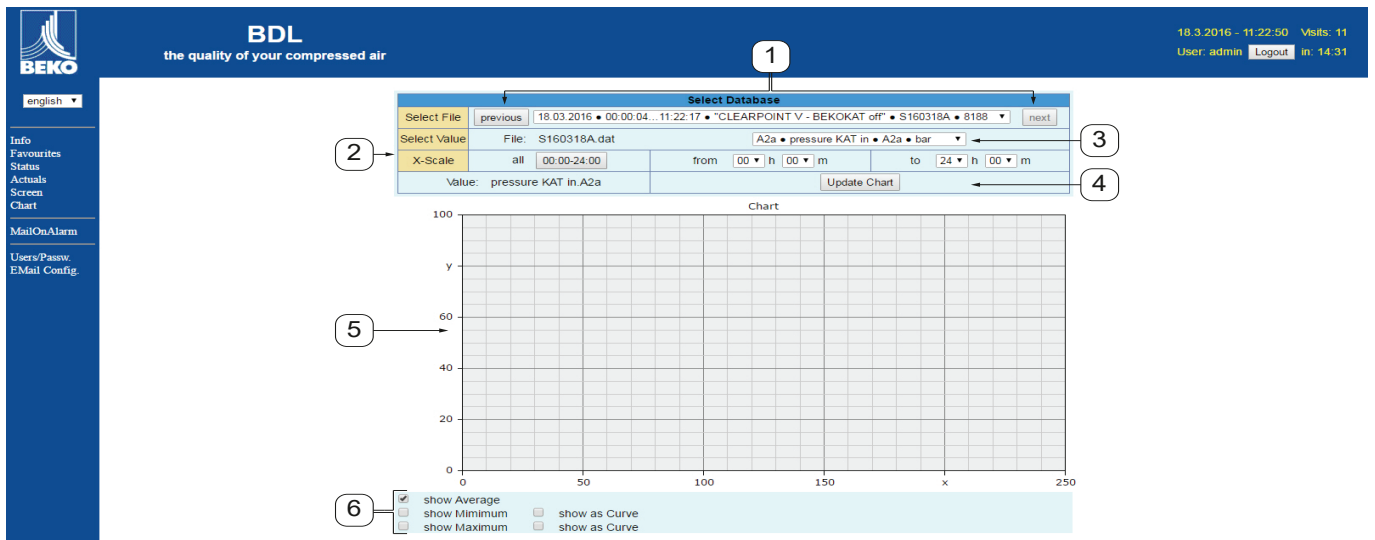

No.	Description
1	Selection of measurements stored on the SD card Press the >>previous<< and >>next<< to move to the previous/next data record
2	Period for the display of the measurements
3	Select channel to be displayed
4	Draw chart for selected channel
5	Chart plotting area
6	Select measurements to be displayed

12.9.10. AlarmMail

This menu allows you to have e-mail alerts sent to certain e-mail addresses, if a limit value is exceeded.

The content of the message is preset, but you can add a brief comment.

BDL ALARM

Event: 12.06.2012 18:14:57
 IP: 172.16.4.142
 Hostname: BDL-PMA

Alarm for Relais_1 Level_1 Comment: Flowmeter FS109 - Alarm

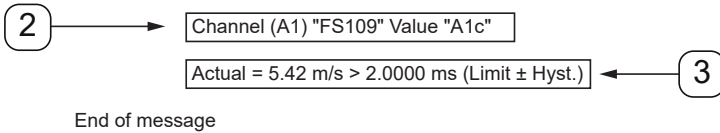

No.	Description
1	Brief comment re. alert
2	Channel and measurement
3	Measured value and respective alarm limit

NOTICE	Setting up alarm mail recipients
	For information on how to configure alarm mail recipients, see User menu, chapter 12.9.10.1, page 112.

12.9.10.1. User

In this menu, you can configure the users of the web server and define their access rights.

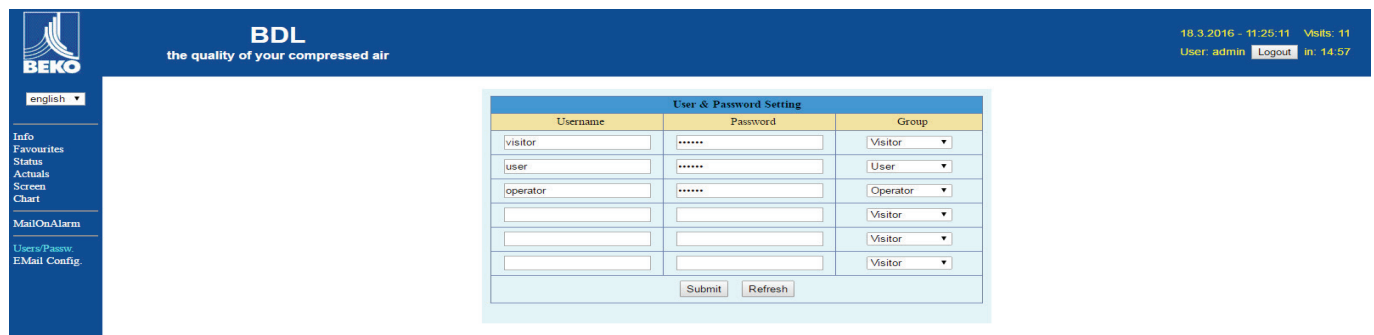

The access rights are assigned to user groups. The available user groups are listed in the table below:

User groups	Access rights					
	Info	Status	display	Chart	AlarmMail	User/mail recipient management
no login	X					
Guest	X	X	X			
User	X	X	X	X		
Operator	X	X	X	X	X	
Administrator	X	X	X	X	X	X

Available:

min. 4 characters; max. 12 characters
 No special characters

12.9.10.2. EMail

This menu is used to set up e-mail recipients for alarm mails. You also have the option to test the e-mail alert function. For configurations, consult your IT department.

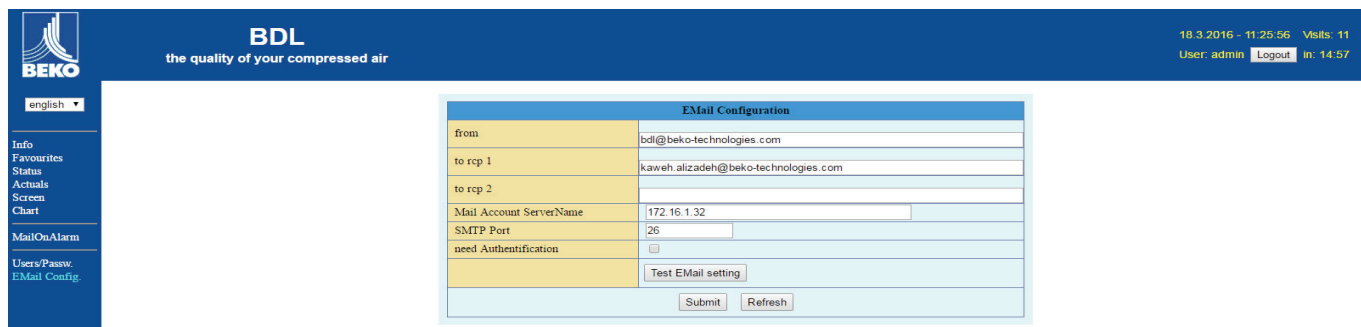

Press the >>Test e-mail settings<< button to call up a browser window showing the process of the test.

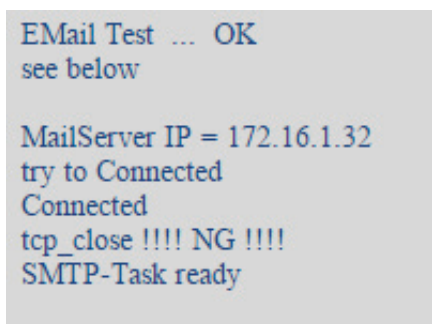

Successfully completed e-mail test

12.10. Exporting data

This menu allows you to export stored data to a USB memory stick.

Main menu ► Export data

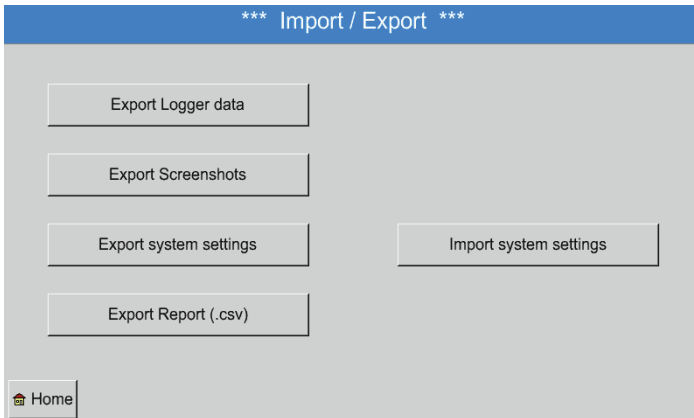

Press the **Export logger data**, **Export system settings**, and **Export report** buttons to export the measuring data as well as the settings to a USB memory stick.

Main menu ► Export data ► Export logger data

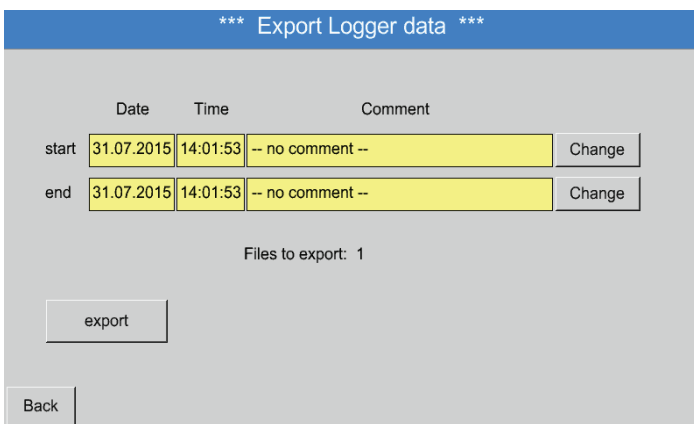

Press the **Select** buttons to select the **Start** and **End** time of the period you wish to export. The stored measured data captured within the set period is exported.

Main menu ► Export data ► Export logger data ► Selection

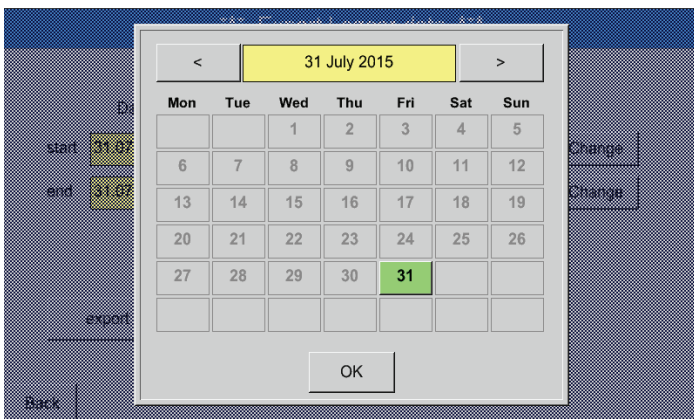

The selected date is highlighted in green. Sundays are highlighted in red.

The buttons of dates for which there are measuring data are raised.

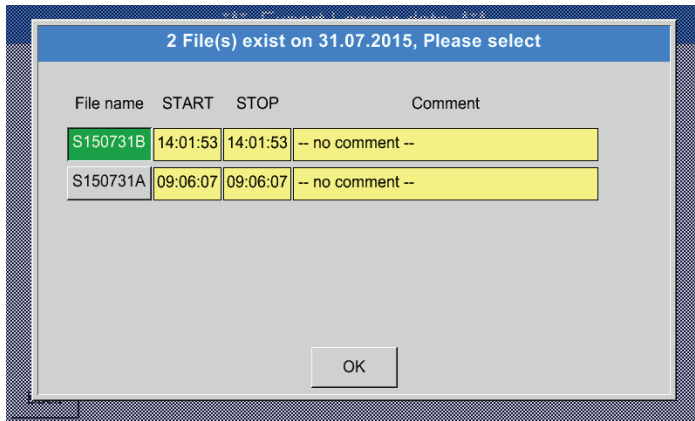

If there are several measurements for a date, they are listed after you have confirmed the selected date with **OK**.

Select the desired record from the list.

Main menu ► Export data ► Export logger data ► Export

The measuring data of the selected period are exported to a USB memory stick.

Main menu ► Export data ► Export system settings

Press the **Export system settings** button to export all existing sensor settings to a USB memory stick.

Main menu ► Export data ► Export report

Press the **Export report** button to export the **Report** in CSV format to a USB memory stick.

12.10.1. Creating screenshots

To create a screenshot, press



Screenshots can be taken in the following menus:

- Main menu ► Charts ►
- Main menu ► Chart/current values ►
- Main menu ► Channels ►
- Main menu ► Current values ►
- Main menu ► Settings ► Sensor Settings

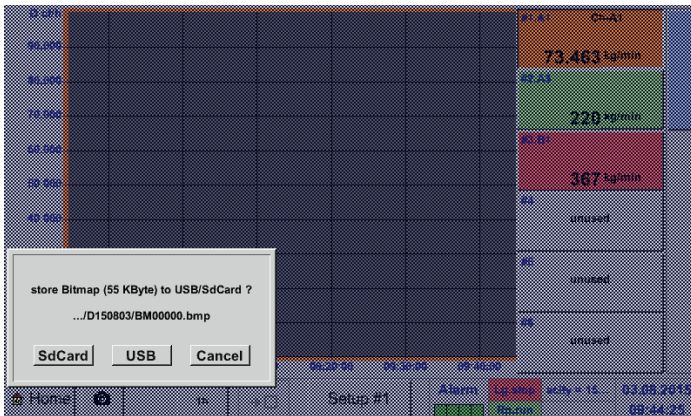

The screenshots can be saved to a USB memory stick or the SD card.

The screenshots are automatically dated (current date) and numbered consecutively.

Syntax of the screenshot file name: DJJMMTT
 Identifier (D=date)
 JJ = Year
 MM= Month
 TT= Day

File path: DEV001/Hostname/Bitmap

For more information regarding the host name, see:

[Main menu ► Settings ► System overview](#)

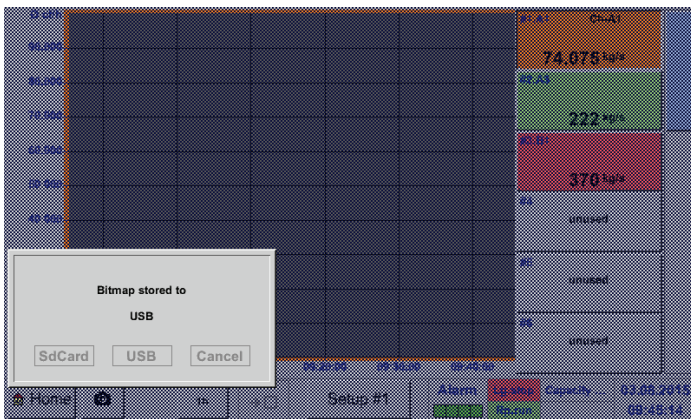

Example:

First screenshot created on 26 February 2014
 ► \\DEV001\DE-5001\Bitmap\D140226\B00000.bmp

12.10.2. Exporting screenshots

The saved screenshots can be exported to a USB memory stick.

Main menu ► Export data

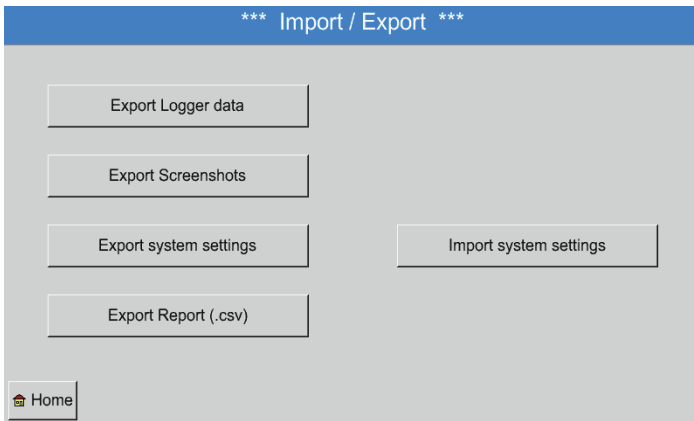

To export the saved screenshots, press the **Export screenshots** button.

Main menu ► Export data ► Export screenshots

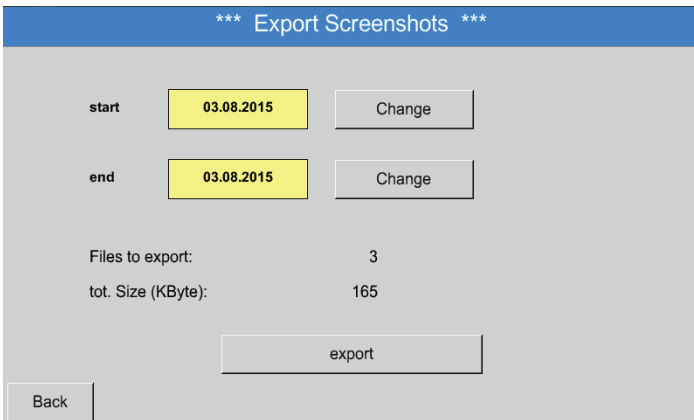

Press the **Select** buttons to define the period for which you wish to export the screenshots.

All the screenshots that have been created during this period are exported when the **Export** button is pressed.

Main menu ► Export data ► Export screenshots ► Selection

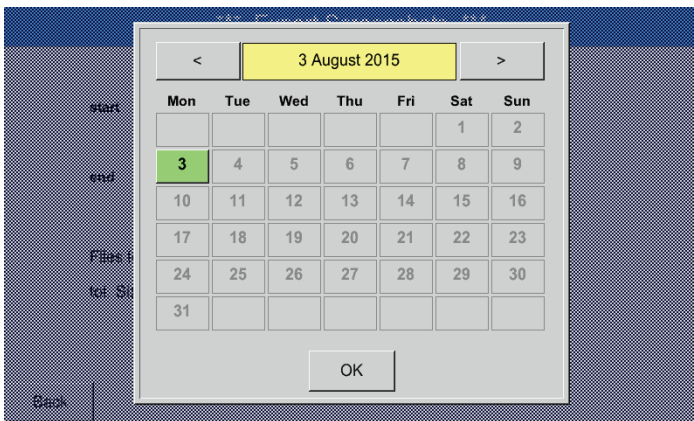

The selected period is highlighted in green.

The buttons of dates for which there are measuring data are raised (bold print).

13. Cleaning/decontamination

NOTICE	Cleaning
	The METPOINT® BDL has a cleaning function which protects the display against unintentional operation when cleaning it. For details, see chapter 12.7.3.

Clean the METPOINT® BDL with a slightly damp (not wet) cotton cloth or disposable wipe, and a mild, conventional cleaner/soap.

To decontaminate the device, spray the decontamination product on a clean cotton cloth or disposable wipe and thoroughly wipe the device. Then dry the device with a clean cloth or let it dry at room temperature.

Observe the locally applicable hygiene regulations.

WARNING	Risk of damage to device
	Excessive humidity, the use of hard and pointed implements and aggressive cleaners can cause damage to the data logger and to the integrated electronic components.

Preventive measures

- Never clean the device with a wet cloth.
- Do not use aggressive detergents.
- Do not clean or operate the device with hard or pointed implements.

14. Dismantling and disposal

Disposal of the device according to the WEEE Directive (Waste Electrical and Electronic Equipment): Electrical and electronic waste must not be disposed as normal household waste. To dispose of the product, dismantle it. Materials such as glass, plastics and some chemical compounds are, recoverable, reusable, or recyclable.

According to the above Directive, the METPOINT® BDL is classified in category 9. According to §5, section 1 of the German Electrical and Electronic Equipment Act (ElektroG), the METPOINT® BDL is not subject to any restrictions regarding hazardous substances. According to §9, section 7 (ElektroG), the METPOINT® BDL from BEKO TECHNOLOGIES GmbH can be returned to the manufacturer for disposal.

WARNING	Risk to health and the environment!
	Never dispose of the device with normal household waste! Depending on the medium used in the device, it might be contaminated with residues that can pose a risk to health and the environment. Therefore, take suitable protective measures and dispose of the device through the proper channels.

Actions:

When dismantling components, clean them without delay to remove any medium residue.

15. Declaration of Conformity

BEKO TECHNOLOGIES GMBH
Im Taubental 7
41468 Neuss

GERMANY

Tel: +49 2131 988-0
www.beko-technologies.com



EU-Konformitätserklärung

Wir erklären hiermit, dass das nachfolgend bezeichnete Produkt den Anforderungen der einschlägigen Richtlinien und technischen Normen entspricht. Diese Erklärung bezieht sich nur auf das Produkt in dem Zustand, in dem das Produkt von uns in Verkehr gebracht wurde. Nicht vom Hersteller angebrachte Teile und/oder nachträglich vorgenommene Eingriffe bleiben unberücksichtigt.

Produktbezeichnung:	METPOINT® BDL
Modelle:	BDL04, BDL08, BDL12
Spannungsversorgung:	100 ... 240 VAC / 1 Ph. / PE / 50-60 Hz
Schutzart:	IP 65
Umgebungstemperatur:	0 °C ... +50 °C
Datenblatt:	DB_BDLV2-0322-A
Produktbeschreibung und Funktion:	Datenlogger zur stationären Messdatenerfassung und Speicherung, für industrielle Anwendungen

Niederspannungs-Richtlinie 2014/35/EU

Angewandte harmonisierte Normen: EN 61010-1:2010

EMV-Richtlinie 2014/30/EU

Angewandte harmonisierte Normen: EN 61326-1:2013

ROHS II-Richtlinie 2011/65/EU

Die Vorschriften der Richtlinie 2011/65/EU zur Beschränkung der Verwendung bestimmter gefährlicher Stoffe in Elektro- und Elektronikgeräten werden erfüllt.

Das Produkt ist mit dem abgebildeten Zeichen gekennzeichnet:



BEKO TECHNOLOGIES GMBH trägt die alleinige Verantwortung für die Ausstellung dieser Konformitätserklärung.

Neuss, 21.03.2022

BEKO TECHNOLOGIES GMBH

i.V. Christian Riedel
Leiter Qualitätsmanagement International

BEKO TECHNOLOGIES GMBH
Im Taubental 7
41468 Neuss

GERMANY

Phone: +49 2131 988-0
www.beko-technologies.com



EU Declaration of Conformity

We hereby declare that the product named below complies with the stipulations of the relevant directives and technical standards. This declaration only refers to the product in the condition in which it has been placed into circulation by us. Parts which have not been installed by the manufacturer and/or modifications which have been implemented subsequently remain unconsidered.

Product designation:	METPOINT® BDL
Models:	BDL04, BDL08, BDL12
Voltage supply:	100 ... 240 VAC / 1-phase / PE / 50 ... 60 Hz
Degree of protection:	IP 65
Ambient temperature:	0 °C ... +50 °C
Data sheet:	DB_BDLV2-0322-A
Product description and function:	Data logger for stationary data recording and storage; designed for industrial applications

Low Voltage Directive 2014/35/EU

Applied harmonised standards: EN 61010-1:2010

EMC Directive 2014/30/EU

Applied harmonised standards: EN 61326-1:2013

RoHS II Directive 2011/65/EU

The products meet the requirements laid down in European Directive 2011/65/EU concerning the restriction on the use of certain hazardous substances in electrical and electronic devices.

The product bears the mark shown:



BEKO TECHNOLOGIES GMBH shall have sole responsibility for issuing this Declaration of Conformity.

Neuss, 21 March 2022

BEKO TECHNOLOGIES GMBH

i.V. Christian Riedel
Head of International Quality Management

EU-DecI_BDL-B-EN_03.22.docx

BEKO TECHNOLOGIES GmbH

Im Taubental 7
 D - 41468 Neuss
 Tel. +49 2131 988 0
 Fax +49 2131 988 900
 info@beko-technologies.com
 service-eu@beko-technologies.com

DE**BEKO TECHNOLOGIES LTD.**

Unit 11-12 Moons Park
 Burnt Meadow Road
 North Moons Moat
 Redditch, Worcs, B98 9PA
 Tel. +44 1527 575 778
 info@beko-technologies.co.uk

GB**BEKO TECHNOLOGIES S.à.r.l.**

Zone Industrielle
 1 Rue des Frères Rémy
 F - 57200 Sarreguemines
 Tél. +33 387 283 800
 info@beko-technologies.fr
 service@beko-technologies.fr

FR**BEKO TECHNOLOGIES B.V.**

Veenen 12
 NL - 4703 RB Roosendaal
 Tel. +31 165 320 300
 benelux@beko-technologies.com
 service-bnl@beko-technologies.com

NL**BEKO TECHNOLOGIES (Shanghai) Co. Ltd.**

Rm.715 Building C, VANTONE Center
 No.333 Suhong Rd.Minhang District
 201106 Shanghai
 Tel. +86 (21) 50815885
 info.cn@beko-technologies.cn
 service1@beko.cn

CN**BEKO TECHNOLOGIES s.r.o.**

Na Pankraci 58
 CZ - 140 00 Praha 4
 Tel. +420 24 14 14 717 /
 +420 24 14 09 333
 info@beko-technologies.cz

CZ**BEKO Tecnológica España S.L.**

Torruella i Urpina 37-42, nave 6
 E - 08758 Cervelló
 Tel. +34 93 632 76 68
 Mobil +34 610 780 639
 info.es@beko-technologies.es

ES**BEKO TECHNOLOGIES LIMITED**

Room 2608B, Skyline Tower,
 No. 39 Wang Kwong Road
 Kwloon Bay Kwloon, Hong Kong
 Tel. +852 2321 0192
 Raymond.Low@beko-technologies.com

HK**BEKO TECHNOLOGIES INDIA Pvt. Ltd.**

Plot No.43/1 CIEEP Gandhi Nagar
 Balanagar Hyderabad
 IN - 500 037
 Tel. +91 40 23080275 /
 +91 40 23081107
 Madhusudan.Masur@bekoindia.com
 service@bekoindia.com

IN**BEKO TECHNOLOGIES S.r.l**

Via Peano 86/88
 I - 10040 Leinì (TO)
 Tel. +39 011 4500 576
 Fax +39 0114 500 578
 info.it@beko-technologies.com
 service.it@beko-technologies.com

IT**BEKO TECHNOLOGIES K.K**

KEIHIN THINK Building 8 Floor
 1-1 Minamiwatarida-machi
 Kawasaki-ku, Kawasaki-shi
 JP - 210-0855
 Tel. +81 44 328 76 01
 info@beko-technologies.jp

JP**BEKO TECHNOLOGIES Sp. z o.o.**

ul. Pańska 73
 PL - 00-834 Warszawa
 Tel. +48 22 314 75 40
 info.pl@beko-technologies.pl

PL**BEKO TECHNOLOGIES S. de R.L. de C.**

BEKO Technologies, S de R.L. de C.V.
 Blvd. Vito Alessio Robles 4602 Bodega 10
 Zona Industrial
 Saltillo, Coahuila, 25107
 Mexico
 Tel. +52(844) 218-1979
 informacion@beko-technologies.com

MX**BEKO TECHNOLOGIES CORP.**

900 Great Southwest Pkwy SW
 US - Atlanta, GA 30336
 Tel. +1 404 924-6900
 Fax +1 (404) 629-6666
 beko@bekousa.com

US

Translation of the original instructions.
 Original instructions are in German.
 mp_bdl_v2_ba_10-377_en_00_00

www.beko-technologies.com

